



Irritrol[®]



**RESIDENTIAL &
COMMERCIAL IRRIGATION**

PRODUCT SPECIFICATION CATALOG 2022-2023

TWO GREAT BRANDS, COUNTLESS SOLUTIONS



As a leader in water management innovation our purpose is to help our customers enrich the beauty, productivity and sustainability of the land through water efficient irrigation resources and solutions. Founded in 1914, Toro is a leading worldwide provider of innovative solutions for the outdoor environment including turf maintenance, snow management, landscape, rental and specialty construction equipment, and irrigation solutions. Through a strong network of distributors, dealers, retailers and rental stores in more than 125 countries, Toro helps customers care for golf courses, sports fields, public green spaces, commercial and residential properties, construction sites and agricultural operations. To learn more, visit www.toro.com.



Irritrol is a leading manufacturer of professional irrigation products for residential and commercial applications, and is the only brand entirely dedicated to industry professionals. With over half a century of service to the professional irrigation industry, Irritrol's time-tested products are built with innovation influenced by strong partnerships and are trusted to reliably perform every season. We understand that you put your reputation on the line with every installation. That's is why we are willing to stand behind the entire line of Irritrol products for a full 5 years after installation. So install with the assurance that you're backed by a company as reliable as the products it sells. Visit Irritrol.com to learn more.

CUSTOMER CARE YOU CAN COUNT ON



Toro Technical Support

Our technical support staff is truly extraordinary at what they do. They have over 100 years of combined irrigation experience that you can depend on. For an excellent support experience, call: **1-877-345-TORO (8676)** or email: irrigation.support@toro.com. For more helpful tips, visit our YouTube site at www.youtube.com/toro.



Toro Controller Repair

Did you know that with Toro's Board Exchange Program you can get the replacement controller boards you need immediately? Through your distributor, controller repair provides controller boards ready for immediate board exchange to assure that controller downtime is minimal and your landscape and reputation stay protected. For immediate assistance call **1-877-345-TORO (8676)**, Monday – Friday, 6:00 AM – 3:30 PM PST. Visit our Controller Repair website at www.toro.com/controller-repair.



Toro Training

Toro offers its customers training and education on new product technology, water management best practices, and provides world-class business skills training for professional contractors to help them increase productivity and improve their bottom line. To learn more about other educational opportunities in your area and nationwide, call **1-877-345-TORO (8676)**.



Toro National Support Network (NSN®)

Toro's National Support Network (NSN) is a team of A+ certified technicians and licensed irrigators dedicated to the daily operations and maintenance of computerized central control systems. Every new Toro computerized central irrigation control system includes Toro NSN support, as well as convenient classroom, web and computer-based training. For assistance call: **1-888-676-TORO (8676)** or visit www.toronsn.com.



Toro Online Information

We offer a complete listing of all irrigation products at (www.toro.com/irrigation) along with links to Distributor locator and product literature. Specialty sites for Specifiers (www.specifier.toro.com) and water management highlights (www.watersmart.toro.com) are full of great information at your fingertips.



CONTROLLERS

Pages 6-31

RESIDENTIAL

Rain Dial®-R Series Controller	8-9
KD2™ Series Controller	10-11
EVOLUTION™ Series Controller	12-13

COMMERCIAL

TEMPUS™ DC Series Controller	14-15
LXC Series Controller	16-17
Total Control Series Controller	18-19
Eagle™ Series Controller	20-21
Eagle Plus Series Controller	22-23
iCentral™ Web Based Water Management System	24-25

CENTRAL CONTROL

DXi™ Central Control System	26-27
DXi Central Control System (Laguna™)	28-29
DXi Central Control System (WMS)	30-31

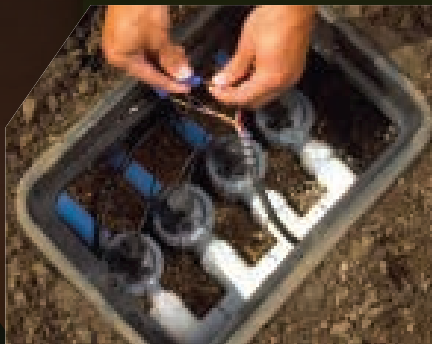

VALVES

Pages 32-69

RESIDENTIAL

2400/2600 Series Valves	34-35
205 Series Valves	36-37
250/260 & 254/264 Series Valves	38-39
2500 Series Valves	40-41
2700 Series Valves	42-43
311 Series Valves	44-45
2623DPR/300 Series Valves	46-47

COMMERCIAL

700 Series Valves	48-49
200B Series Valves	50-51
252 Series Valves	52-53
100 Series Valves	54-55
100-S Series Valves	56-57
P-220 Series Valves	58-59
P-220S Scrubber Series Valves	60-61
220 Brass Series Valves	62-63
Quick Coupler Series	64-65

VALVE ACCESSORIES

Omnireg® Modular Pressure Regulator	66
Valve Accessories	66
Valve Service Kits	67
SR-1 Pump Start Relay	68



SPRAYS & NOZZLES

Pages 70-99

SPRAYS

570Z Series Spray Bodies	72-73
570Z PR Series Spray Bodies	74
570Z XF Series Spray Bodies	75
I-PRO™ Series Sprays	76-77
I-PRO PR Series Sprays	78-79
LPS Series Sprays	80-81

NOZZLES

Precision™ Series Spray Nozzles	82-83
MPR & MPR Plus Spray Nozzles	84-85
TVAN Variable Arc Nozzles	86-87
I-PRO™ Nozzles	88-89
PRO-Van Nozzles	90-91
Pressure-Compensating Flood Bubblers	92
500 Series Bubblers	92
Stream Spray Nozzles	93
Stream Bubbler Nozzles	93
533 Bubbler Nozzles	94

FLEX PIPE

Super Funny Pipe®	95
Super Funny Pipe Swing Joints	95
Super Blue Flex® Series	96
Super Blue Flex Assemblies	97
Super Blue Flex Fittings	97

SPRAYS ACCESSORIES

Precision™ Check Valve	98
Spray Tools & Accessories	99



ROTORS

Pages 100-123

RESIDENTIAL

T5 RapidSet® Series Rotors	102-103
MINI 8 Series Rotors	104-105
300 Series Multi-Stream Rotor®	106-107
Titan™ Impact Rotor	108-109

COMMERCIAL

T7 Series Rotors	110-111
640 Series Rotors	112-113
TS90 Series Rotors	114-115

LARGE-AREA

TS170 Series Rotors	116-117
TS120 Series Impact Sprinklers	118-119
P2 Series Sprinklers	120-121
Roll CarT™ Traveling Sprinkler	122-123



LANDSCAPE DRIP

Pages 124-143

DRIP LINE

DL2000™ Series Subsurface Dripline	126-127
17mm Drip In® Brown Surface Dripline	128-129
Blue Stripe® Polyethylene Hose	130-131
Tri-Loc™ Fittings	132
Drip Fittings and Accessories	133

EMMITERS

NGE® Emitters	134-135
Turbo-SC™ Plus Pressure-compensating Emitter	136
Varis™ and Varistake™ Adjustable Emitters	137
Pressure Regulating Multi-Outlet Drip Manifold	137
Spray to Drip Retro Fit Kit	138
E-2™ Classic Take Apart Emitter	139
Drip Bubblers	140

VALVES

Plastic Y Filters	141
Pressure Regulators	141
Drip Zone Valve Kits	142-143



SENSORS

Pages 142-163

WEATHER & MOISTURE

RainSensor™ Series	146-147
Climate Logic® System	148-149
Precision™ Soil Sensor	150-151
Pro Series™ Soil Sensor	152
Turf Guard® Wireless Soil Monitoring System	153
Wireless ET Weather Sensor	154-155

FLOW SENSORS

Flow Sensors	156
TFS Flow Sensors	157

REMOTES

TMR Maintenance Remote	158
EVOLUTION® Smart Connect® Remote	159
EICON Remote	160
Pro Max™ Remote	161
CRR Series	162

CONTROLLERS



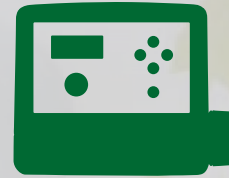

CONTROLLERS

Pages 6-31

RESIDENTIAL

Rain Dial® -R Series Controller	8-9
KD2™ Series Controller	10-11
EVOLUTION® Series Controller	12-13

COMMERCIAL

TEMPUS™ DC Series Controller	14-15
LXC Series Controller	16-17
Total Control Series Controller	18-19
Eagle™ Series Controller	20-21
Eagle Plus Series Controller	22-23
iCentral™ Web Based Water Management System	24-25

CENTRAL CONTROL

DXi™ Central Control System	26-27
DXi Central Control System (Laguna™)	28-29
DXi Central Control System (WMS)	30-31



RAIN DIAL®-R SERIES CONTROLLER

FEATURES & BENEFITS

Climate Logic Ready

Automatically reschedules Rain Dial-R watering based on the weather

SMRTSCAPE™ Ready

Provides remote control from any mobile device or computer through the SMRTSCAPE platform

Remote Control and RainSensor™ Ready

Compatible with the R-100-KIT and equipped with a sensor bypass switch and terminal for sensor hookup

Three Independent Programs

Programming flexibility to meet the needs of a wide variety of plant material on the landscape site

Three Water Day Choices

- Any day of the week, skip days or odd/even dates
- Skip days and odd/even dates have day exclusion option

Water Budgeting

For quick changes to the watering durations of all stations on a program at one time or pre-set a change in water budget for each month

365-day Calendar for Odd/Even Date Watering

Meets the odd/even date watering mandates often used for landscape water reductions

Water Well Recovery (Delay Between Stations)

Option of pump circuit ON or OFF during delay

Master Valve/Pump Start Circuit Assignable Per Station

Stations requiring a booster pump can be supplied while other stations can run on street water pressure

Test All Stations Program

Allows a quick test of all stations from lowest to highest number

Clear/Erase Memory By Program

Saves time by quickly erasing only the program desired

Program Stack or Overlap Option

Allows three programs/stations on at once or restricts operations to no overlapping station runs



Rain Dial-R controllers are EPA WaterSense® Certified when paired with Climate Logic

OPTIONAL ACCESSORIES	
<p>SMRT Logic Bundle (SMRT-CLMR-KIT)</p>	<p>Wireless RainSensor (RS1000 or RFS1000)</p>
<p>Wired RainSensor (RS500)</p>	<p>CRR Remote Series (R-100-KIT)</p>
<p>Climate Logic (CL-100-Wireless)</p>	<p>SR-1 Pump Start Relay</p>

SPECIFICATIONS

Operating

- Three independent programs
- Three start times per program
- Multiple watering day options
- Station run times: 1-59 minutes in 1-minute increments or 1-5.9 hours in .1-hour (6 minute) increments

Dimensions

- Outdoor/Indoor: H: 7 ¾", W: 10 ¾", D: 4"

Warranty

- Five years

Electrical

- Transformer input: 120V AC, 60Hz (220/240V AC, 50Hz available internationally)
- Transformer output: 24V AC, 1.25 amps
- Maximum output per station: 24V AC, .5 amps
- Maximum output to valves: 24V AC, 1.0 amps (including master valve/pump start circuit)
- Battery backup for "armchair" programming and keeping current time and date: 9-volt alkaline (not included)
- UL and CSA listed



Specifying Information – Rain Dial®-R Series Controller

XXX-XXX			
Model	Station Count	Configuration	
RD	XXXX	XXX	R
RAIN DIAL	600 - 6 Station 900 - 9 Station 1200 - 12 Station	EXT - Outdoor INT - Indoor MOD - Module	RainSensor ready
Example: A Rain Dial 6 station, outdoor model = RD600-EXT-R			

RAIN DIAL-R SERIES CONTROLLER MODEL LIST

Model	Description
RD600-EXT-R	6-Station, Outdoor
RD900-EXT-R	9-Station, Outdoor
RD1200-EXT-R	12-Station, Outdoor
RD600-INT-R	6-Station, Indoor
RD900-INT-R	9-Station, Indoor
RD1200-INT-R	12-Station, Indoor
RD6-MOD-R	Module assembly, 6-Station
RD9-MOD-R	Module assembly, 9-Station
RD12-MOD-R	Module assembly, 12-Station



KD2™ SERIES CONTROLLER

FEATURES & BENEFITS

Climate Logic® Compatible

Automatic/weather-based adjustment from your wireless weather sensor (on site)

Three Independent Programs

Allows differing watering days, start times, station run times and station assignments

Multiple Watering Day Options

Provides flexibility to meet water restrictions and diverse plant requirements:

- Days-of-the-week, odd/even date watering with 31st day skip and exclusive day-interval, repeating day-interval

Compatible with CRR Series Hand-held Remote System

Provides convenient remote station start/pause/resume/off capability (R-100-KIT) for supplemental watering or inspection

Self-diagnostic, Electronic Circuit Breaker

Identifies and overrides an electrical “short” in a valve or in valve wiring and continues to water operable stations

Full Family of Indoor and Outdoor Models

Ensures a product to match any landscape

Dedicated Rain Sensor™ Port

For use with Irritrol wired or wireless RainSensor™ or compatible models

Program Stacking Feature

Prevents program overlap

Electrical Surge Protection (on both input and output lines)

Resists damage from lightning storms and power surges

Rugged Indoor and Outdoor Cabinet with a Door

Provides a clean look and security when needed (Outdoor models equipped with a lock)



Rain Dial-R controllers are EPA WaterSense® Certified when paired with Climate Logic

Additional Features

- ✓ Compatible with SMRT Logic® for 2-way cloud control through SMRTscape™
- ✓ Simple & familiar dial-based programming
- ✓ Large LCD displays status of programs scheduled to run each day
- ✓ Non-volatile memory maintains programming information in the absence of AC power
- ✓ Competitively priced for everyday use
- ✓ Locking cabinet (outdoor models)

SPECIFICATIONS

Operating

- Three independent programs
- Station run times: 1-240 minutes (4 hours) in 1-minute increments
- Three start times per program

Dimensions

- Outdoor/Indoor: H: 8", W: 6", D: 4 1/2"

Warranty

- Five years

Electrical

- Transformer input: 120 V AC, 60HZ (220/240 V AC, 50 Hz)
- Transformer output: 24 V AC, 1.250 amps
- Maximum output per station: 24 V AC, .4 amp
- Maximum total output: 24 V AC, .8 amp (including master valve)
- Battery backup for "armchair" programming and keeping current time and date: 9-volt alkaline (not included)
- Capacity: (1) station valve plus a master valve (or 24 V AC pump start relay) on at a time
- UL and CUL listed



Outdoor Model



Indoor Model



- ① Any-day-of-the-week watering
- ② Odd/Even day watering
- ③ Day interval watering from 1-31 days
- ④ Up to 3-starts per day per program

OPTIONAL ACCESSORIES



SMRT Logic Bundle (SMRT-CLMR-KIT)



Wireless RainSensor (RS1000 or RFS1000)



Wired RainSensor (RS500)



CRR Remote Series (R-100-KIT)



Climate Logic (CL-100-Wireless)



SR-1 Pump Start Relay

KD2™ SERIES CONTROLLER MODEL LIST

Model	Description
KD400-EXT	4-Station Outdoor
KD600-EXT	6-Station Outdoor
KD900-EXT	9-Station Outdoor
KD400-INT	4-Station Indoor
KD600-INT	6-Station Indoor
KD900-INT	9-Station Indoor

Specifying Information – KD2™ Series Controller

XXX-XXX		
Model	Station Count	Configuration
KD	XXX	XXX
KD2 Seires	400 -4 Station 600 - 6 Station 900 - 9 Station	EXT - Outdoor INT - Indoor
Example: A KD2 9 station, outdoor model = KD900-EXT		



EVOLUTION® SERIES CONTROLLER



FEATURES & BENEFITS

Ease of Use

Shortcut buttons provide quick access to basic functions while the advanced menu leverages the experience and knowledge of the irrigation professional.

Water-Saving Wireless Accessories

The unique Smart Connect® receiver plugs into the back of the front panel, enabling it to wirelessly communicate directly with a number of add-on devices, including the wireless ET Weather Sensor, Precision™ Soil Sensor, Handheld Remote, and up to two Auxiliary Relays.

Control from Anywhere

Manage your clients' new or existing EVOLUTION Series controllers through the internet using the SMRT Logic® gateway and SMRTscape™ mobile app or website.

Powerful Features

The EVOLUTION controller comes standard with features ready to meet the wide-ranging needs of your clients, such as three independent watering schedules, a stand-alone Auxiliary schedule, modular expansion from 4 to 16 zones, and the capability to power up to four standard solenoids.



Additional Features

- ✓ Three scheduling choices:
 - Seven-day calendar
 - 1- to 30-day interval with up to seven day exclusions
 - Odd/even days with up to seven day exclusions
- ✓ Pump start delay from 10 seconds to 30 minutes
- ✓ Master valve ON/OFF by zone



When equipped with a Wireless ET Weather Sensor (EVO-WS)



SPECIFICATIONS

Electrical

- Electrical input power:
 - 120V ac
 - 30 VA maximum
 - UL, CUL Listed
- Station output power:
 - 24V ac
 - 0.75 amps per station maximum
 - 0.75 amps pump/master valve
 - 1.0 amps total load
- Surge Protection:
 - 6.0 KV common mode; 1.0 KV normal mode
- Operation of two solenoids per station

Dimensions

- 11¹/₄" W x 7³/₄" H x 4¹/₄" D
- Weight: 4.5 lbs.

Warranty

- Five years

EVOLUTION SERIES MODEL LIST

Model	Description
EVO-4ID	4-station Indoor Controller
EVO-4OD	4-station Outdoor Controller
Add-ons and Accessories	
EMOD-4	4-station Expansion Module
EMOD-12	12-station Expansion Module
EVO-SC	Smart Connect® Plug-In Receiver
PSS-SEN	Wireless Precision™ Soil Sensor
EVO-WS	Wireless ET Weather Sensor
EVO-HH	Wireless Handheld Maintenance Remote
EVO-AR	Wireless Auxiliary Relay
SMRT-T	SMRT Logic® Internet Gateway

Programming Features

- ✓ Up to six schedules:
 - Three irrigation schedules with four start times per schedule
 - One wired auxiliary schedule, plus two optional wireless auxiliary schedules
- ✓ Monthly season adjust by schedule
- ✓ Schedule stacking, with automatic split cycle when watering adjustments are greater than 100%
- ✓ Grow-In schedule can be set for up to 90 days and automatically reverts to base irrigation schedule
- ✓ Station runtimes from one minute to twelve hours
- ✓ Allows 30, 60, or 90 second manual runtimes for things such as winterization/blowouts
- ✓ Programmable well-recovery, station, or pump start delays from 10 seconds to 30 minutes
- ✓ Timed water off from one to fourteen days
- ✓ Compatible with normally-closed rain sensors
- ✓ Automatic short detection for circuit protection and faster troubleshooting
- ✓ Non-volatile memory doesn't require batteries and holds programming for up to five years
- ✓ Diagnostic zone test measures and displays current draw of solenoid and identifies short, over current and open conditions

Hardware Features

- ✓ Backlit LCD display
- ✓ 4-station base; expandable to 16-stations with 4- and 12-station hot-swappable modules
- ✓ Powerful 1.25 mA transformer can run up to 4 standard solenoids at once
- ✓ Red LED next to display lights in the event of an alert
- ✓ Option for 9V battery allows for armchair programming
- ✓ Outdoor key-lock cabinet manufactured out of durable UV-resistant plastic and includes standardized key used on many of the most popular controllers
- ✓ Indoor cabinet includes internal transformer and factory installed power cord

Specifying Information- EVOLUTION® Series

EVO-XX-XX-SC			
Description	Cabinet Type	Module	Connector Options
EVO	XX	XX	SC
EVO – EVOLUTION Controller	ID – Indoor OD – Outdoor	4 – No Additional Modules 8 – One, 4-Station Modules 12 – Two, 4-Station Modules 16 – One, 12-Station Module	SC – Smart Connect®
Example: A 16-station EVOLUTION controller in an indoor cabinet with Smart Connect would be specified as: EVO-ID-16-SC			



12-station configuration with two 4-station modules (EMOD-4)



16-station configuration with one 12-station module (EMOD-12)



TEMPUS™ DC SERIES CONTROLLER

FEATURES & BENEFITS

Battery Operated

Ideal for managing irrigation in areas without an electrical connection.

Saves Time

Easily access and program the TEMPUS DC battery-operated controller with your bluetooth enabled smartphone or tablet through the free TEMPUS DC mobile app.

Rain Sensor Ready

Rain sensor compatibility ensures that irrigation does not occur during a rain event.

Water Savings

With water budget, seasonal irrigation can be easily set up for the whole year, and the run times can then be adjusted from 0% to 200% in increments of 10%.

Integrated Wireless Connectivity

Allow intuitive programming through the new Toro TEMPUS DC mobile app.



SPECIFICATIONS

Dimensions & Weights

- TEMPUS DC with LCD: 4.1" x 6.1" x 1.9"
(W x H x D) / 0.57 pounds
- TEMPUS DC without LCD: 4.5" x 4.5" x 1.9"
(W x H x D) / 0.55 pounds

Power

- 1 x 9V or 4 x 1.5V AAA batteries
- Compatible with Toro®, Irritrol®, and Hunter® DC latch-type solenoids
- Maximum 1 station ON at a time
- Valve wire runs up to 325 feet (20 AWG wire)

Working Pressure

- Qualified on DCL samples up to 85 psi of water pressure

Working Temperature

- From 14°F to 122°F

Warranty

- Two years

Additional Features

- ✓ Simple and easy app navigation
- ✓ 1-, 2-, 4-, and 6-station models available
- ✓ Four independent watering programs with three start times per program
- ✓ Watering schedule by 7 day calendar, day interval or odd/even days
- ✓ Automatic program stacking in cases of start time and/or runtime overlap
- ✓ Run times up to 8 hours with 1 minute increment
- ✓ Permanent program retention in memory without battery
- ✓ Waterproof (IP68) and submersible up to 6½ feet
- ✓ Input for a wired rain sensor

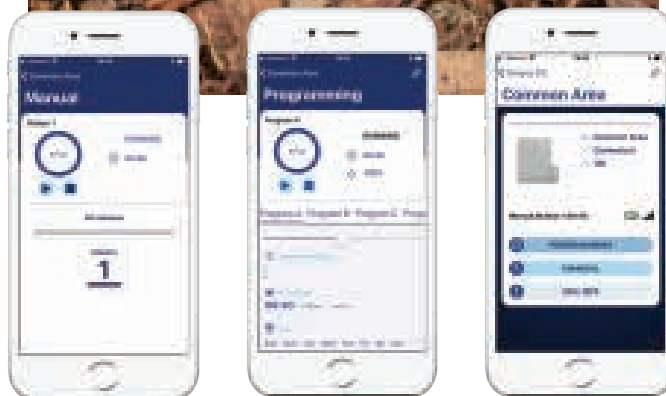

Actual app screens.

TEMPUS DC LCD CONTROLLER MODEL LIST

Model	Description
TEMP-1-DC-L	1-Station Controller
TEMP-2-DC-L	2-Station Controller
TEMP-4-DC-L	4-Station Controller
TEMP-6-DC-L	6-Station Controller

TEMPUS NON-LCD CONTROLLER MODEL LIST

Model	Description
TEMP-1-DC	1-Station Controller
TEMP-2-DC	2-Station Controller
TEMP-4-DC	4-Station Controller
TEMP-6-DC	6-Station Controller

Specifying Information – TEMPUS DC Controller

XXX-XXX		
Tempus Controller	Station Count	Interface
X	X	DC
TEMP	1 - 1-Station 2 - 2-Station 4 - 4-Station 6 - 6-Station	L - with LCD screen (Blank) - no screen
<p>Example: A 2-station Tempus DC controller with an LCD interface would be specified as: TEMP-2-DC-L</p>		



LXC SERIES CONTROLLER

FEATURES & BENEFITS

Flexible Irrigation Management Solution

Ideal for large-scale residential and light-commercial applications.

Convenient & Easy to Use

Familiar dial functionality, a large color display and intuitive navigation buttons ensure a short learning curve and quick start up.

Flexible Station Capacity

With 12 fixed stations and modular station expansion up to 52 stations, LXC is ideal for a wide variety of standard system installations or expansions.

8 Programs, 8 Start times

Standard 8 programs, each with 8 start times, and the ability to run up to four simultaneous stations or programs.

Two-Wire Compatible

2-Wire models with 60 and 100 stations makes LXC a convenient, economical and easy to manage choice for large residential or light commercial job sites.

Hassle Free Installation

Station modules' quick connect feature and confirmation LED automatically aligns the module and confirms a secure connection.

Flow Sensor Compatible

Flow sensing capability and support for a variety of sizes and manufacturers to monitor and address unexpected events, minimizing damage, water loss and financial impact.

Efficient Weather-Based Watering

Compatible with Irritrol Wireless Weather Sensor to automatically adjust watering schedules based on site specific weather conditions.



Additional Features

- ✓ Ability to operate up to 4 stations simultaneously
- ✓ Flow monitoring with ability to learn individual station flow
- ✓ Self-diagnostics include short detection, overflow, underflow and unscheduled flow
- ✓ Manual operations with ability to pause automatic watering
- ✓ Water budget, both global and seasonal
- ✓ Cycle and Soak
- ✓ Grow In Scheduling
- ✓ Station delay
- ✓ Rain Sensor ready
- ✓ SMRTSCAPE™ compatible – for cloud-based remote programming



Certified by
ICC-ES

SPECIFICATIONS

Operating

- Station run times: 1-24 hours in 1-minute increments
- Start times: 8 per program per day for 64 starts total
- Watering schedules per program:
 - Any day of the week
 - Skip days from 1 to 31 days between irrigation days
 - Odd or even date watering

Dimensions

- Plastic and Metal Cabinet: H:15.3", W: 15.5", D: 6.4"

Warranty

- Five years

Electrical

- Indoor/Outdoor models - Domestic: Built-in 50VA end bell transformer
- Transformer input: 120V AC, 50/60Hz, .7 amps
- Transformer output: 24V AC, 50/60Hz, 1.6 amps
- Maximum output per station: 24V AC, .5 amps (4-stations max, plus 2 pump/master)
- Power outage protection
 - Program information stored in non-volatile memory
 - Data retention with no battery
 - Date/time retention up to 2 weeks with replaceable battery
- UL and CSA listed

LXC SERIES CONTROLLER MODEL LIST

Model	
LXC12-I	12 station, indoor with plastic wall mount
LXC12	12 station, outdoor with plastic wall mount
LXC12-M	12 station, outdoor with painted metal wall mount
LXC12-S	12 station, outdoor with stainless wall mount
LXC60	60 station, 2-wire, with plastic wall mount
LXC60-M	60 station, 2-wire, with painted metal wall mount
LXC100	100 station, 2-wire, with plastic wall mount
LXC100-M	100 station, 2-wire, with painted metal wall mount
LXC100-S	100 station, 2-wire, with stainless wall mount
LXC8-MOD	LXC 8 St. Expansion Module
LXC-SMRT-R	Radio Communication Card

Specifying Information – LXC Series Controller

XXXX-X-XXX-X

Model	Station Count	Configuration	Type
LXC	X	XXX	X
LXC Series Controller	BLANK = no station 8 = 8 station, expansion conv.	MOD = Expansion module SMRT = SMRT Logic accessory	RADIO = 900 MHZ radio comm. card

Example: A SMRT Logic radio communication card = **LXC12-SMRT-RADIO**

Specifying Information – LXC Series Controller

XXXX-X-XXX-X

Model	Station Count	Enclosure	Configuration
LXC	X	XXX	XXX
LXC Series Controller	12-station conventional 60-station 2-wire 100-station 2-wire	BLANK = Plastic Wall Mount M = Painted Metal Wall Mount S = Stainless Steel Wall Mount	BLANK = Outdoor I = Indoor, Plastic WM

Example: A LXC 12-station, painted metal cabinet, outdoor model = **LXC12-M**

OPTIONAL ACCESSORIES

	
SMRT Logic® Wireless Gateway	LXC-SMRT-R Wireless Receiver
	
CL-W1 Wireless Sensor	RS1000 Wireless RainSensor™
	
RFS1000 Wireless Rain/Freeze Sensor	RS500 Wired RainSensor
	
Irritrol Handheld Remote (CL-R1)	Flow Sensors



TOTAL CONTROL®-R SERIES CONTROLLER

FEATURES & BENEFITS

SMRT Logic® Ready

Provides remote control from any internet connected device.

Climate Logic® Compatible

Turns the Total Control into a weather-based controller using an on-site wireless weather sensor.

All “R” Models are Remote-Ready

For Irritrol’s Contractor Residential Remote (CRR) series.

Four Independent Programs Offer Concurrent Operation Capability

For scheduling flexibility.

Seven-day Calendar, Odd/Even Date or Day-Interval Options from One to 30 Days

Provides the flexibility to meet water restrictions or plant watering requirements.

Programmable Master Valve On/Off Per Program

Provides the flexibility of running some programs with a booster pump and some without.

Non-Volatile Memory

Holds program during power failures for reliable operation.

Flexible Station Run and Start Times

Meets a broad range of watering requirements

6-, 9- and 12-Station Models have 12-Station Terminal Boards;

15-, 18- and 24-Station Models have 24-Station Terminal Boards;

Allows for station count increase simply by changing face panel module.

Sensor Hookup with Bypass Switch Compatible with the Irritrol® RainSensor™ Series

Saves water by shutting off the system during rainfall.

12, 18, 24, 36 AND 48-Station Models in Metal

Painted steel commercial grade with locking cabinets for vandal resistance.



12, 18, 24, 36 & 48
Station Models Available in Metal Cabinets

Additional Features

- ✓ User-friendly, 10-position programming dial and large, easy-to-read display
- ✓ Start time stacking within each program
- ✓ Industrial surge protection (on both input & output lines)
- ✓ Self-diagnostic circuit breaker
- ✓ Automatic, semi-auto, manual & timed-manual operation



When equipped with a Wireless ET Weather Sensor (EVO-WS)

Certified by ICC-ES

SPECIFICATIONS

Operating

- Four independent programs
- 16 start times assignable to any program
- Station run times: 1 minute to 10 hours in 1-minute increments
- Water budgeting: 10-200% in 10% increments

Electrical

- Outdoor/Indoor
 - Transformer input: 120 V AC, 60 Hz (220/240 V AC, 50 Hz)
 - Transformer output: 24 V AC, 1.67 amps
- Electronic circuit breaker: 1.25 amps (Min. hold)
- Maximum output per station: 24 V AC, .5 amp
- Maximum output to valves: 24 V AC, 1.25 amps (including master valve)
- Battery backup: 9-volt alkaline battery
- UL & CSA listed (All models up to 18-stations)
- UL & CUL listed (24, 36, & 48-station models)

Programming

- 7-day calendar, odd/even day watering or day-interval options from one to (30) days
- Programmable master valve
- Excluded-day function, when used with the odd/even date option, allows selection of specific day(s) not to water

Dimensions

- Outdoor/Indoor: H: 8½", W: 10½", D: 5"
 - Metal: (12, 18 & 24-station) H: 10¾", W: 9¾", D: 5¾"
 - Metal: (36 & 48-station) H: 15 ¾", W: 10 ¾", D: 5 ¾"

Warranty

- Five years

TOTAL CONTROL®-R SERIES CONTROLLER MODEL LIST

Model	
TC-6EX-R	6-Station Outdoor
TC-9EX-R	9-Station Outdoor
TC-12EX-R	12-Station Outdoor
TC-15EX-R	15-Station Outdoor
TC-18EX-R	18-Station Outdoor
TC-24EX-R	24-Station Outdoor
TC-12EXM-R	12-Station Outdoor (MC)
TC-18EXM-R	18-Station Outdoor (MC)
TC-24EXM-R	24-Station Outdoor (MC)
TC-36EXM-R	36-Station Outdoor (MC)
TC-48EXM-R	48-Station Outdoor (MC)
TC-6IN-R	6-Station Indoor
TC-9IN-R	9-Station Indoor
TC-12IN-R	12-Station Indoor
TC-6MOD-R	Module Assembly, 6-Station
TC-9MOD-R	Module Assembly, 9-Station
TC-12MOD-R	Module Assembly, 12-Station
TC-15MOD-R	Module Assembly, 15-Station
TC-18MOD-R	Module Assembly, 18-Station
TC-24MOD-R	Module Assembly, 24-Station
TC-36MOD-R	Module Assembly, 36-Station
TC-48MOD-R	Module Assembly, 48-Station

MC= Metal Cabinet

OPTIONAL ACCESSORIES	
 <p>SMRT Logic Bundle (SMRT-CLMR-KIT)</p>	 <p>Wireless RainSensor (RS1000 or RFS1000)</p>
 <p>Wired RainSensor (RS500)</p>	 <p>CRR Remote Series (R-100-KIT)</p>
 <p>Climate Logic (CL-100-Wireless)</p>	 <p>SR-1 Pump Start Relay</p>

Specifying Information – Total Control-R Series Controller

TC-XX-XXX-R			
Model	Station Count	Configuration	
LXC	XX	XXX	R
TC - Total Control	6 - 6 Station 9 - 9 Station 12 - 12 Station 15 - 15 Station 18 - 18 Station 24 - 24 Station 36 - 36 Station 48 - 48 Station	EX - Outdoor IN - Indoor MOD - Module EXM - Outdoor, metal cabinet	R - Remote Control Ready
Example: A LXC 12-station, painted metal cabinet, outdoor model = LXC12-M			

*EPA WaterSense® Certified when used with Irritrol® Climate Logic®



EAGLE™ SERIES CONTROLLER



FEATURES & BENEFITS

Automatic ET Schedule Adjustment

The ability to use any of four different ET sources as the basis for ET calculations

Cycle-and-Soak or Conventional Start Times

Four independently controlled programs with 5 selectable start times for a total of 20 possible cycles per day or Cycle-and-Soak with unlimited start times

Flow Sensing

Monitors system flow and responds to upper, lower, unscheduled and no-flow conditions. Flow events can be reported through iCentral

Valve Wiring Faults Detected

Automatic field wire detection enables the controller to sense a short in the field wire and instantly turn off that station

Optional Internet Control

Wireless cellular communication. Faster “real time” internet access to iCentral. No software to purchase, optional weather station and minimal to no training



SPECIFICATIONS

Operating

- Operational Temp: 14° F to 140° F (-10° C to 60° C)
- Storage Temp: -22° F to 149° F (-30° C to 65° C)

Electrical

- Input power required: 105-130 V AC, 50/60 Hz, .5 amp maximum, 1 amp idle
- Output power required: 24 V AC 1.5 amps maximum total output or (36 VA) 1 amp per station or master valve
- UL, CUL, and FCC approved

Dimensions

- EG model: H: 10", W: 13", D: 4½"
- T & ST model: H: 17½", W: 13", D: 4½"
- SPED model: H: 35", W: 16", D: 14"

Specifying Information – Eagle Series Controller

XXXX-X-XXX-X		
Model	Station Count	Configuration
RME	X	XXX
Eagle Series Controller	6 12 18 24 30 36	NONE =Small painted wall mount T=Large painted wall mount with surge protection ST=Large stainless wall mount with surge protection SPED-T=Stainless steel large enclosure pedestal with surge protection
Example: A 24-station Rain Master® Eagle™ in a large stainless wall mount enclosure and surge protection with iCentral option = RME24EG-ST and EG-iCENTRAL		

COMMERCIAL-GRADE LOCKABLE PAINTED & STAINLESS STEEL ENCLOSURES

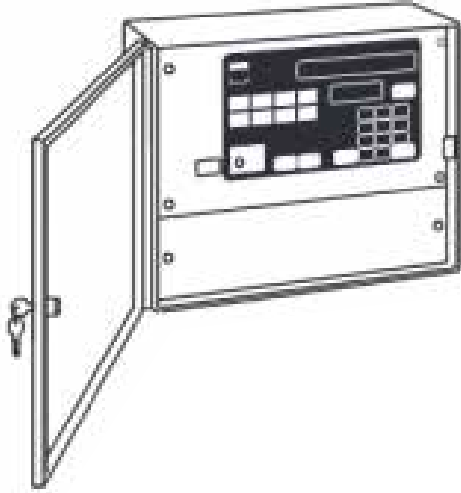

EG Series Standard

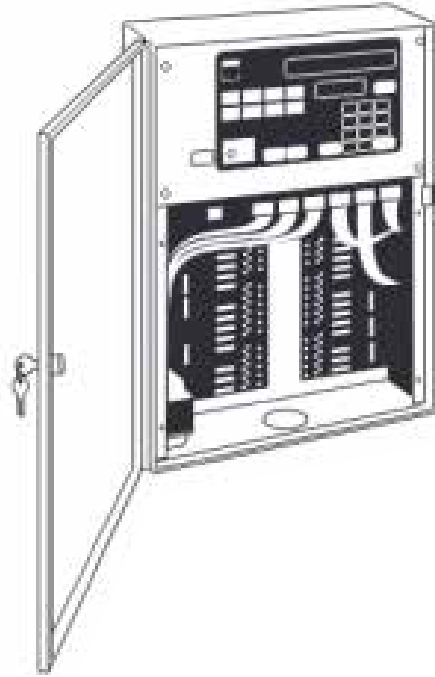

*T Series (painted) Heavy-duty
Lighting/Surge Protection*

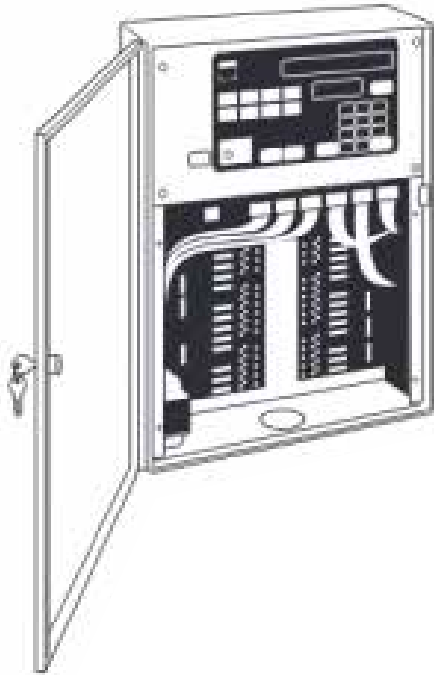

*ST Series (stainless) Heavy-duty
Lighting/Surge Protection*

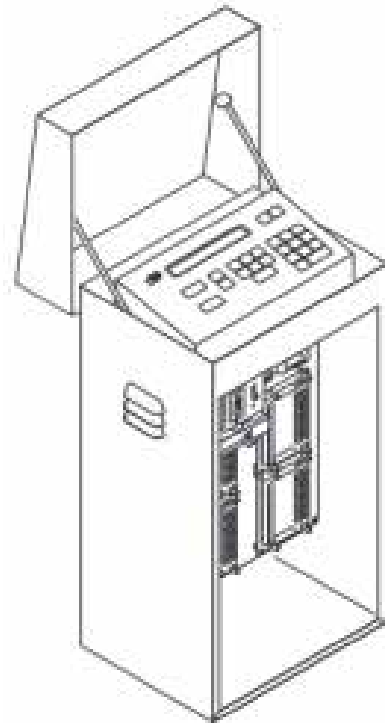

*SPED 14 Gauge Stainless Steel Security
Pedestal with Surge Protection*



EAGLE™ PLUS SERIES CONTROLLER

FEATURES & BENEFITS

Enhanced User Interface

Intuitive operation with multi-line LCD backlit display and simple multi-function input knob.

Dedicated Sensor Input

Dedicated sensor input.

Self Diagnostic and Monitoring Suite

Quickly identify and troubleshoot system issues.

Up to 8-Programs with Conventional/ 16-Programs with 2-Wire

Up to 48 stations conventional configuration and 200 stations in 2-Wire configuration. Up to 16 programs (8 for conventional and 16 for 2-Wire).

Advanced Lightning/Surge Protection

Advanced lightning/Surge protection.

Automatic Fuse/Circuit Reset

Automatic fuse/circuit reset.

Flow Sensing and Control

Monitors system flow and responds to upper, lower, unscheduled and no flow conditions.

iCentral™ Compatible for Full Internet Control

Connect and manage irrigation remotely through iCentral and its Automatic Irrigation Scheduler (AIS) capabilities.

Pro Max™ Direct Port

Directly wire the Pro Max remote control system to the controller to make light work of system checks and audits from up to a mile away (line-of-sight).

Flow Managed Irrigation (FMI)

An iCentral scheduling engine that optimizes irrigation system performance.



Specifying Information – Eagle Plus Series Controller

EGP-X-XXXX		
Model	Station Count	Enclosure
EGP	X	X XXX X
EGP8 EGP	8-station conventional TW = 2-Wire	BLANK = Painted S = Stainless wall mount PPED = Plastic pedestal SPED = 14 gauge stainless steel pedestal PSB = 16 gauge stainless steel pedestal
Example: A 24-station Eagle Plus in a stainless steel pedestal = EGP8-SPED + (2) EGP8-OPB		

EAGLE PLUS SERIES CONTROLLER MODEL LIST

Model	Description
EGP8	8-station expandable, coated steel wall mount
EGP8-S	8-station expandable, stainless steel wall mount
EGP8-SPED	8-station expandable, Rain Master stainless steel security pedestal*
EGP8-PSB	8-station expandable, VIT strong box stainless steel security pedestal*
EGP-TW	2-wire, coated steel wall mount
EGP-TW-S	2-wire, stainless steel wall mount
EGP-TW-SPED	2-wire, Rain Master stainless steel security pedestal*
EGP-TW-PSB	2-wire, VIT strong box stainless steel security pedestal*
EGP8-OPB	8-station module

**All SPED and PSB controllers are built to order in Riverside, CA. Please allow up to 10 days for delivery*

CONTROLLER CONFIGURATION

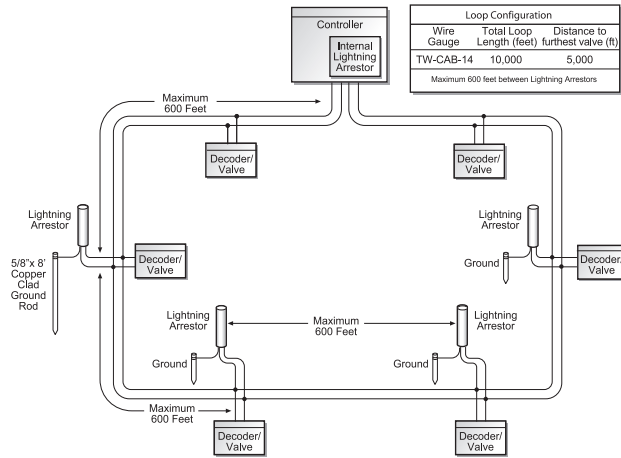

Loop Configuration

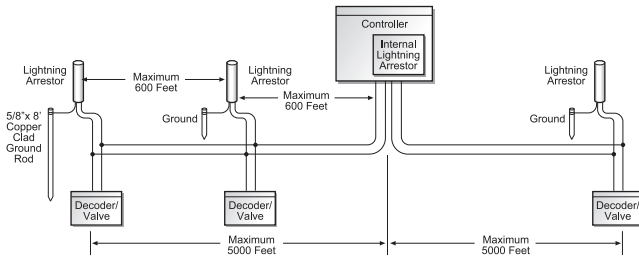

Straight Line Configuration	
Wire Gauge	Total Wire Length (feet)
TW-CAB-14	5,000

Maximum 600 feet between Lightning Arrestors

Straight Line Configuration

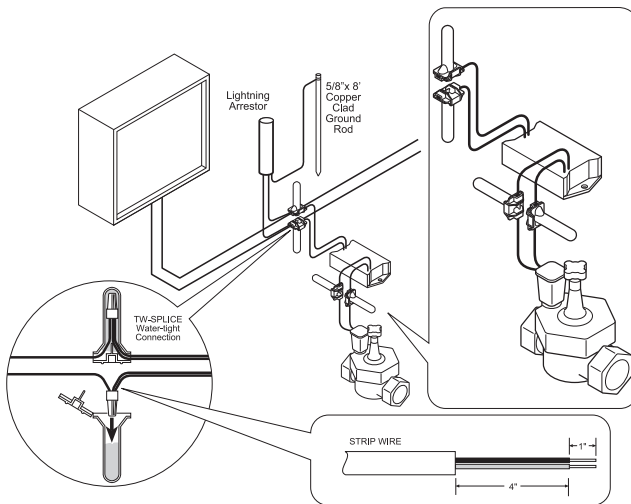

Wire Connection Detail

RAIN MASTER® EAGLE™ PLUS 2-WIRE



Rain Master TWICE™ 2-Wire

Unlike some other 2-wire systems, the Rain Master TWICE™ protocol provides a 2-way communication link between the controller, decoders and valves.

- Provides 200 station two-wire capability for the Rain Master Eagle Plus (100 decoders max.)
- Intelligent “Plug-n-Play” Modular design

TWICE 2-Wire Decoders

- Easy-to-read LED status indication for every command
- LED also displays valve activation and diagnostic reporting
- Troubleshooting capabilities:
 - LED decoder “active” indication
 - LED valve power “on” indication
 - Two-way communication verification
- Each decoder has unique address
- Decoders will automatically shut off if communication is lost
- A short automatically shuts down any valve
- Valves can be operated up to 100’ radius of the decoder

2-WIRE DECODERS AND ACCESSORIES MODEL LIST

Model	Description
TW-D-1	Single valve AC decoder
TW-D-2	Dual valve AC decoder
TW-D-4	Quad valve AC decoder
TW-LA-1	Lightning arrester (every 600 feet)
TW-SPLICE-14	14-gauge water-tight connectors
TW-CAB-14	14-gauge (red/black) Polycoated (blue) wire



iCENTRAL™ WEB BASED WATER MANAGEMENT SYSTEM



The patented Rain Master® iCentral™ water management system is the original web-based landscape control platform. It allows wireless central control for one or more Rain Master Eagle™ and Eagle™ Plus Series irrigation “field” controller(s). The iCentral website utilizes reliable 2-way wireless or ethernet* communication from the internet to interface with each field controller and provides alert notifications for a variety of system conditions. An entire irrigation system, no matter how large, can be reliably managed through the iCentral web service.

- **Automatic Schedule Generator (ASG)** determines the optimal schedule based on seasonality and site parameters: irrigation efficiency, soil texture, plant type, slope, precipitation, etc.
- **Intelli-Sync™** Monitors changes made at iCentral or in the field
- **ZipET™** automatically sends weather information every 24-hours to each controller based local zip code. The controller intelligently modifies scheduled station runtimes by replacing just enough water to maintain plant health
- Mobile freindly website for Smart Phone and Tablet
- **Smart Alerts™** are sent by text or email for all field alarms generated when a “fault” occurs; text messages are sent to cell phone and email address
- Automatic initiation of “rain shutdown” to each controller if iCentral determines that precipitation in a designated area necessitates a shutdown
- Manually turn on/off any station or program
- Optional flow sensors detect flow violations and when appropriate, shuts off station(s). Subsequent programming automatically progresses and alert messages are sent for each affected station

iCENTRAL MODEL LIST

Model	Description
EG-ICENTRAL	RME Eagle Cellular communication kit with 12-months of iCentral service
EGP-ICENTRAL	Eagle Plus Cellular communication kit with 60-months of iCentral service
EGP-ETHER	Eagle Plus Ethernet communication kit with 60-months of iCentral service
RM-ISVC-5Y	Additional 60-months of iCentral service (Cellular)
RM-ISVCETHR-5Y	Additional 60-months of iCentral service (Ethernet)

FLOW MANAGED IRRIGATION (FMI)*



*Graphs may vary as they are based on available flow, water window and programming constraints.



Eagle™ Plus

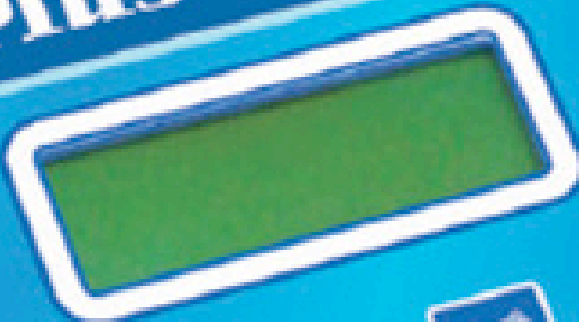

ALARM SENSATION



PROGRAM



SETUP



HOME



MANUAL



REVIEW



WATER OFF



DXI™ CENTRAL CONTROL SYSTEM



FEATURES & BENEFITS

Compatible with Laguna™ or Sentinel® Water Management Software

A single powerful hardware platform capable of supporting two powerful software packages

Convenient Mobile Access

The free ProMax™ Connect app offers irrigation managers access to DXi controllers from anywhere, anytime.

Cloud-Based Data Management

Simplifies irrigation management with access from anywhere, anytime.

Build to Order

Comes in a variety of configurations, from multiple enclosure options, to multiple irrigation methods: conventional, 2-wire or hybrid.

Multiple Communication Options

Including cellular; cellular communication kits include 10-years of service with no initial service subscription.

Future Ready Hardware Platform

accommodates new innovations and changing site needs quickly and economically.

Range of Functionality

DXi offers a wide range of functionality, from basic irrigation scheduling to ET, Flow-Sharing and Flow Management.

Evolve at your own Pace

Current Laguna and WMS users can retrofit their existing irrigation controllers without having to replace the central software.





PROMAX™ Connect

The ProMax Connect App is a free cloud-based maintenance remote tool that allows users to operate stations and programs. With a simple and user-friendly interface, troubleshooting field issues can be performed with ease from your mobile device. ProMax Connect is available for download on the Google™ Play Store and Apple® App Store*.

Additional Features

- ✓ Valid Program Activation
- ✓ Single or Multi-Station Activation
- ✓ Monitor Real-Time Flow Rates
- ✓ Rain Hold Management
- ✓ Create & Activate a One-Time Program “Syringe”
- ✓ Monitor and Manage Alerts
- ✓ All Station Test Implementation & Management
- ✓ View Local Weather in Real Time

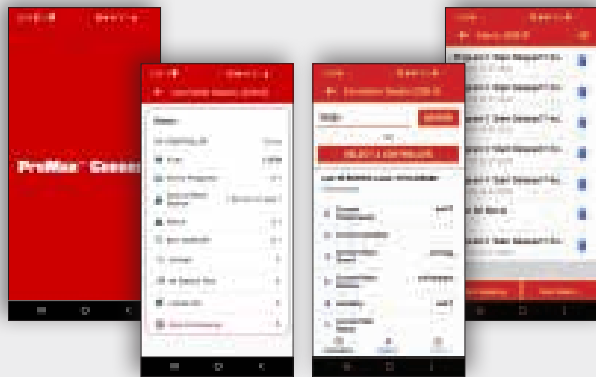

**Google Play store and Apple App Store are trademarks or registered trademarks of their respective companies in the United States and other countries.*

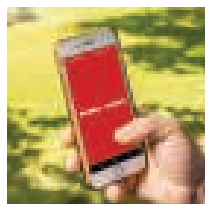

SPECIFICATIONS

Electrical

- Input power: 100-120VAC, 50/60HZ
- Output power: 24VAC, 2.75 amps max total draw @ 140°F (60°C), 2.5 amps max per station/pump/master valve
- Transformer: 24VAC, 100VA
- UL, CUL & FCC approved

Dimensions

- PWM: H:23” W:19” D:8”
- SWM: H:23” W:19” D:9”
- SPED: H:35” W:16” D:14”
- PSB: H:38” W:16” D:15.5”
- DPSB: H:38” W:24” D:17”
- PPED: H:35” W:16” D:14”

Communication Options

- ✓ Cellular (ProMax Connect Compatible)
- ✓ Serial
- ✓ Ethernet (ProMax™ Connect Compatible)
- ✓ Ethernet-to-radio
- ✓ UHF Radio
- ✓ Wi-Fi (ProMax Connect Compatible)

Pivoting Bracket for Easy Installation

“Fridge Light” Cabinet Illumination*

**Standard in all models*

Custom-fit Covers for All Boards

Pivotech Pivoting Mounting Brackets



LAGUNA™ CENTRAL CONTROL SYSTEM

FEATURES & BENEFITS

- ✓ VP mapping tools provide an easy way to locate and program DXi™ infield controllers, weather sources and other devices using zoom features. Highlight any DXi controller and launch programming screens, view alerts, or manually turn on stations with a click.
- ✓ Software updates over the internet
- ✓ Internet based mapping (Road or Aerial)
- ✓ Dynamic activity log allows operation statuses to be viewed
- ✓ ET source from weather station, CIMIS or online ET data
- ✓ Simultaneous port communication for faster service
- ✓ Grid and table editing for user customization
- ✓ Customize plant & soil types, as well as flow meters
- ✓ Virtual Machine (VM) compatible

Advanced ET and AIM

- ✓ Utilizes water budget scheduling method
- ✓ Provides complete water use accountability
- ✓ Irrigation schedule based on plant requirements
- ✓ Generates water usage projections
- ✓ Optimize scheduling efficiency and system performance
- ✓ Extensive system flow management
- ✓ Global programming functions

**Windows is a registered trademark of Microsoft Corp.*



DXI™ CONTROLLER SPECIFICATION

Firmware for Central Control Configuration*	
DXi-FMW-LAGUNA	For Rain Master Laguna Central System Only
Controller Model	
DXi-	DXi Irrigation Controller
Enclosure Type	
PWM	Painted Wall Mount Enclosure
SWM	Stainless Steel Wall Mount Enclosure
SPED	Stainless Steel Pedestal Enclosure, Type 1
PSB	Stainless Steel Pedestal Enclosure, Type 2
PPED	Plastic Pedestal Enclosure
DPSB	Stainless Steel Pedestal Double Wide Enclosure
Station Count	
TW	200-Station 2-Wire Output Gateway
08	8-Station Conventional Output
16	16-Station Conventional Output
24	24-Station Conventional Output
32	32-Station Conventional Output
40	40-Station Conventional Output
48	48-Station Conventional Output
56	56-Station Conventional Output, DPSB Enclosure Only
64	64-Station Conventional Output, DPSB Enclosure Only
72	72-Station Conventional Output, DPSB Enclosure Only
80	80-Station Conventional Output, DPSB Enclosure Only
88	88-Station Conventional Output, DPSB Enclosure Only
96	96-Station Conventional Output, DPSB Enclosure Only
HY08	8-Station Conventional Output w/TW Output Gateway, SPED Enclosure Only
HY16	16-Station Conventional Output w/TW Output Gateway, SPED Enclosure Only
HY24	24-Station Conventional Output w/TW Output Gateway, SPED Enclosure Only
HY32	32-Station Conventional Output w/TW Output Gateway, SPED Enclosure Only
HY40	40-Station Conventional Output w/TW Output Gateway, SPED Enclosure Only
HY48	48-Station Conventional Output w/TW Output Gateway, SPED Enclosure Only
Communication Add-on	
M8C	Cellular Kit with Antenna (Includes 10-years of Service)
M8W	Wi-Fi Kit with Antenna
M8U	UHF Radio Kit with Antenna
Other Add-on	
P	ProMax™ Remote Receiver Kit

* Each DXi order must include the firmware version SKU.

Additional Features for Laguna™ Configuration

- ✓ 8-96 stations conventional/200 stations 2-wire
- ✓ Hybrid option available*
- ✓ Built to order with many configurations to choose from
- ✓ 16 programs + independent station control (ISC)
- ✓ 12 start times per program
- ✓ 2 customizable establishment programs & up to 48 "omit day(s)"
- ✓ Dedicated port for up to 3 master valves, 3 flow sensors & 2 pumps
- ✓ Compatible with 2-Wire Moisture Sensor

*48-Station Conventional output + 152-Station 2-wire output in SPED enclosure

2-WIRE DECODERS AND ACCESSORIES MODEL LIST

Model	Description
TW-D-1	Single valve AC decoder
TW-D-2	Dual valve AC decoder
TW-D-4	Quad valve AC decoder
TW-LA-1	Lightning arrester
TW-CAB-14	14 AWG polycoated 2-wire
TW-SPLICE-14	14 AWG water-tight splices
TW-PROG	Portable decoder programmer
TW-DAC-FLOW	Flow sensor decoder
TW-DAC-SOIL	Moisture sensor device



SENTINEL® WMS CENTRAL CONTROL SYSTEM

FEATURES & BENEFITS

Simple To Use

Microsoft® Windows®-based software – daily operations and scheduling are made quick and easy.

Features For Water Management

ET-based watering, flow sensing and optimization, water usage report with historical comparison maximize system efficiency.

Smartphone and Tablet Connectivity

The new Sentinel WMS software package includes Android, iPhone®, and iPad™ connectivity for remote programming and alerts on ALL new systems.

Multiple Communication Options

Communication options like radio, Wi-Fi, cellular, and Ethernet can be mixed and matched to meet system requirements.

Distributed Programming

Stores irrigation programs in the computer while allowing irrigation control at the satellite level, ensuring the loss of a component does not result in the loss of irrigation across the system.

Toro NSN® Support

All centrals come with a minimum of two years of NSN support – unlimited 24-hour toll-free support with 24/7/365 emergency paging.

AC Decoder Highlights

- ✓ Wire fault detection automatically shuts down valve
- ✓ Easy-to-read LED status indication for every command
- ✓ LED also displays valve activation and diagnostic reporting
- ✓ Troubleshooting capabilities:
 - LED decoder “active” indication
 - LED valve power “on” indication
 - Two-way communication verification

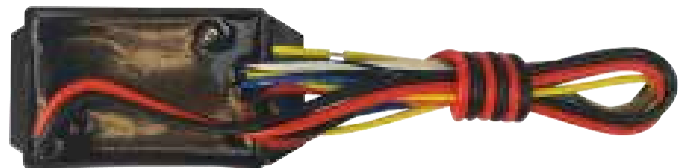

Additional Features for WMS Configuration

- ✓ Conventional station configurations options range from 8 to 204*, 2-Wire configuration option from 1 to 204 and Hybrid systems range from 8 to 204 stations
- ✓ Built to order with many configurations to choose from
- ✓ 16 conventional programs with 8 start times per program
- ✓ Built-in remote control jack for ProMax™ (permanent internal remote mount available)
- ✓ Up to 48 “omit day(s)”
- ✓ 900MHz radio for wireless output boards (WOBs) compatibility (communicate to up to 4 WOBs per satellite)
- ✓ Compatible with Turf Guard® Wireless Soil Sensor and 2-Wire Moisture Sensor.

*48-Station Conventional output + 152-Station 2-wire output in SPED enclosure

DXI™ CONTROLLER SPECIFICATION

Firmware for Central Control Configuration*	
DXi-FMW-WMS	For Toro Sentinel WMS Central System Onlyv
Controller Model	
DXi-	DXi Irrigation Controller
Enclosure Type	
PWM	Painted Wall Mount Enclosure
SWM	Stainless Steel Wall Mount Enclosure
SPED	Stainless Steel Pedestal Enclosure, Type 1
PSB	Stainless Steel Pedestal Enclosure, Type 2
PPED	Plastic Pedestal Enclosure
DPSB	Stainless Steel Pedestal Double Wide Enclosure
Station Count	
TW	200-Station 2-Wire Output Gateway
08	8-Station Conventional Output
16	16-Station Conventional Output
24	24-Station Conventional Output
32	32-Station Conventional Output
40	40-Station Conventional Output
48	48-Station Conventional Output
56	56-Station Conventional Output, DPSB Enclosure Only
64	64-Station Conventional Output, DPSB Enclosure Only
72	72-Station Conventional Output, DPSB Enclosure Only
80	80-Station Conventional Output, DPSB Enclosure Only
88	88-Station Conventional Output, DPSB Enclosure Only
96	96-Station Conventional Output, DPSB Enclosure Only
HY08	8-Station Conventional Output With TW Output Gateway, SPED Enclosure Only
HY16	16-Station Conventional Output With TW Output Gateway, SPED Enclosure Only
HY24	24-Station Conventional Output With TW Output Gateway, SPED Enclosure Only
HY32	32-Station Conventional Output With TW Output Gateway, SPED Enclosure Only
HY40	40-Station Conventional Output With TW Output Gateway, SPED Enclosure Only
HY48	48-Station Conventional Output With TW Output Gateway, SPED Enclosure Only
Communication Add-on	
M8C	Cellular Kit with Antenna (Includes 10-years of Service)
M8W	Wi-Fi Kit with Antenna
M8U	UHF Radio Kit with Antenna
Other Add-ons	
P	ProMax™ Remote Receiver Kit
E	900MHZ XTND Radio Kit, WMS DXi Only
PE	ProMax Remote Receiver Kit with 900MHZ XTND Radio Kit, WMS DXi Only

* Each DXi order must include the firmware version SKU.

SENTINEL CENTRAL MODEL LIST

Model	Description
CENTRAL SOFTWARE/COMPUTER MODELS	
SGIS-1-T	Software Only with 2 years of NSN* Support
DXi-ETHER-RF-RPTR	DXi Ethernet to Radio Base Station with Antenna (AKA CTM)
NSN SUPPORT EXTENSION MODELS	
SSE-T-1	1 year Extension for SGIS-0-1 of SGIS-1-T
SSE-T-3	3 year Extension for SGIS-0-1 of SGIS-1-T
SSE-C-1	1 year Extension for SGIS-1-0 (with computer warranty)
SSE-C-3	3 year Extension for SGIS-1-0 (with computer warranty)

SAMPLE SPECIFICATION

Example: DXI-FMW-WMS + DXI-SPED48M8CP

WMS configured DXi 48-station controller in stainless steel pedestal (SPED), cellular kit with antenna and 10-years communication service, and ProMax permanent mount remote receiver with antenna.

2-WIRE DECODERS AND ACCESSORIES MODEL LIST

Model	Description
SB-DAC-1	1-station AC decoder
SB-DAC-2	2-station AC decoder
SB-DAC-4	4-station AC decoder
SB-BLA	AC in-line surge protection
TW-CAB-14	14 AWG polycoated 2-wire
TW-SPLICE-14	14 AWG water-tight splices
TW-PROG	Portable decoder programmer
TW-DAC-FLOW	Flow sensor decoder
TW-DAC-SOIL	Moisture sensor device

VALVES



Irritrol[®]



VALVES

Pages 32-69

RESIDENTIAL

2400/2600 Series Valves	34-35
205 Series Valves	36-37
250/260 & 254/264 Series Valves	38-39
2500 Series Valves	40-41
2700 Series Valves	42-43
311 Series Valves	44-45
2623DPR/300 Series Valves	46-47

COMMERCIAL

700 Series Valves	48-49
200B Series Valves	50-51
252 Series Valves	52-53
100 Series Valves	54-55
100-S Series Valves	56-57
P-220 Series Valves	58-59
P-220S Scrubber Series Valves	60-61
220 Brass Series Valves	62-63
Quick Coupler Series	64-65

VALVE ACCESSORIES

OmniReg® Modular Pressure Regulator	66
Valve Accessories	66
Valve Service Kits	67
SR-1 Pump Start Relay	68



2400/2600 SERIES VALVES

FEATURES & BENEFITS

Flexible Irrigation Management Solution Threaded Bonnet Design

Allows easy servicing without removal from the system

Rugged, Double-beaded Diaphragm

Ensures a leak-proof seal

Internal and External Bleed (Flush mode)

Allows for manual operation

Full Stainless-steel Metering System

Allows for consistent valve operation

Heavy-duty, Corrosion and UV-Resistant PVC, Glass-filled Polypropylene and Stainless Steel Construction

Durable, long-term performance

Available in Multiple Configurations—female NPT, Slip, Male x Male and Male x Female

Will handle all regional installation variances
(2600 available with NPT threads only)

Additional Features

- ✓ Buna-N valve seat seal
- ✓ Floating bleed tube allows thermal expansion without affecting performance
- ✓ Encapsulated injection-molded solenoid with a captive hex plunger
- ✓ Optional flow control



2600T



2400T-B



2400T

SPECIFICATIONS

Operating

- Flow range: .25-30 GPM
- Pressure range: 10-150 ps

Warranty

- Five years

Dimensions

- 2400: H: 5½", W: 3", L: 4"
- 2600: H: 6½", W: 3", L: 3¾"

Electrical

- Solenoid: 24 V ac
- Inrush volt-amp: 24 V ac-9.6 VA
- Inrush current: .4 amp
- Holding volt-amp: 24 V ac-4.8 VA
- Holding current: .2 amp

PRODUCT HIGHLIGHT

VALVE SERVICING MADE EASY

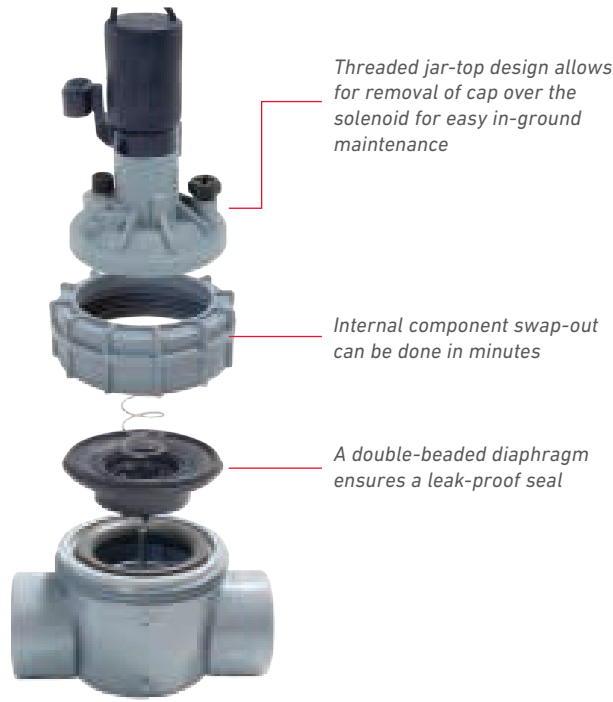

2400|2600 SERIES VALVES MODEL LIST

Model	Description
2400S	1" globe slip connection valve
2400SF	1" globe slip connection w/flow control
2400T	1" globe NPT threaded connection
2400TF	1" globe NPT threaded connection w/flow control
2400T-B	1" globe male x barb connection
2400TF-B	1" globe male x barb connection w/flow control
2400T-M	1" globe male x male connection
2400TF-M	1" globe male x male connection w/flow control
2600T	1" angle NPT threaded connection
2600TF	1" angle NPT threaded connection w/flow control

OPTIONAL ACCESSORIES

Recycled-water Solenoid Kit (RW60-KIT)
purple solenoid with purple warning tag

DC Latching Solenoid (DCL)
Note: Maximum pressure for a valve that utilizes latching solenoid is 120 psi

Threaded Bonnet Wrench (2400-45)

2400|2600 SERIES VALVES PRESSURE LOSS DATA

Model	Size	gpm Flow						
		.25	2	5	10	15	20	30
2400 Series	1"	5.00	4.60	3.50	4.00	2.97	3.26	6.20
2600 Series	1"	5.00	4.60	3.34	2.15	1.78	1.90	3.85

1) Pressure loss data derived from valves independently tested by CIT (Fresno, CA)

** Optional accessories are field-installable. Must specify separately if required.

Specifying Information – 2400 Series Valves

XXXX-X-X-X			
Model	Configuration	Feature	Body Options
2400	X	X	X
2400 globe valve	S - Slip Connection T - NPT Threads	F = Flow Control	B - Male x Barb M - Male x Male
Example: A 2400 globe valve with slip connection and flow control = 2400SF			

Specifying Information – 2600 Series Valves

XXXX-X-X		
Model	Configuration	Feature
2600	X	X
2600 angle valve	T - NPT Threads	F = Flow Control
Example: A 2600 angle valve with NPT threads and flow control = 2600TF		

205 SERIES VALVES

FEATURES & BENEFITS

Heavy-duty, Corrosion and UV-Resistant PVC Construction

Proven durability.

High-Flow, Low Friction Loss Design

More efficient system design and low-flow capability.

Rugged, Nylon-reinforced Buna-N Diaphragm

Ensures a leak-proof seal.

Available in Female NPT or Slip Configurations (No male pipe adapter required)

Will handle all regional installation variances.

Optional Flow Control

Allows precise adjustment and manual shutoff.

Additional Features

- ✓ Buna-N valve seat seal
- ✓ Full stainless steel metering system and floating bleed tube
- ✓ Encapsulated injection-molded solenoid with a captive hex plunger



205T



205S



205TF



205SF

SPECIFICATIONS

Operating

- Flow range: .25-30 GPM
- Pressure range: 10-150 ps

Warranty

- Five years

Dimensions

- H: 5½", W: 2¾", L: 5"

Electrical

- Solenoid: 24 V ac
- Inrush volt-amp: 24 V AC-9.6 VA
- Inrush current: .4 amp
- Holding volt-amp: 24 V AC-4.8 VA
- Holding current: .2 amp

PRODUCT HIGHLIGHT

OVER 50 YEARS OF DEPENDABILITY



A flat fiber washer diaphragm allows the 205 to work in a wide flow range as well as easily handle debris.

205 SERIES VALVES MODEL LIST

Model	Description
205S	1" slip connection
205SF	1" slip connection with flow control
205T	1" NPT threaded connection
205TF	1" NPT threaded connection with flow control

OPTIONAL ACCESSORIES



** Optional accessories are field-installable. Must specify separately if required.

205 series Valves Pressure Loss Data

Model	Size	gpm Flow						
		.25	2	5	10	15	20	30
205 Series	1"	5.40	3.82	3.00	2.20	1.90	3.10	5.10

1) Pressure loss data derived from valves independently tested by CIT (Fresno, CA)

Specifying Information – 205 Series Valves

XXXX-X-X		
Model	Configuration	Feature
205	X	X
205 globe valve	S - Slip Connection T - NPT Threads	F = Flow Control

Example: A 205 globe valve with NPT threads and flow control = **205TF**

TORO.

250/260 & 254/264 SERIES VALVES

FEATURES & BENEFITS

Heavy-duty Toro Solenoid

Provides dependable operation and long life.

Optional Flow Control

Allows the ability to adjust the flow of each zone.

Comprehensive Inlet and Outlet Choices

Flexibility for new installations and retrofit projects.

Single-piece Rubber Diaphragm

For reliable, leak-tight closing.

Tough, Glass-filled Nylon Bonnet and ABS Body

Durable construction that provides years of reliable operation.

Additional Features

- ✓ Self-cleaning, stainless steel metering pin
- ✓ External manual bleed
- ✓ 18" lead wires (electric)
- ✓ Low in-rush solenoid



Effluent
Options
Available



SPECIFICATIONS

Operational

- Flow range:
 - 3/4": 0.25 to 15.0 gpm
 - 1": 5.0 to 30.0 gpm
- Operating Pressure
 - 3/4": 10 to 150 psi
 - 1": 20 to 150 psi
- Solenoid: 24 Vac
 - 3/4": Inrush: 0.25 amps, 6.00 VA; Holding: 0.19 amps, 4.56 VA
 - 1": Inrush: 0.30 amps, 7.20 VA; Holding: 0.20 amps, 4.80 VA
- Burst pressure safety rating: 380 psi

Dimensions

- 3/4": 3" H x 4" W
- 1" 250 & 254 (with flow control): 6" H x 4 1/2" W
- 1" 260 & 264 (without flow control): 4 1/2" H x 4 1/2" W

Warranty

- Two years

PRODUCT HIGHLIGHT

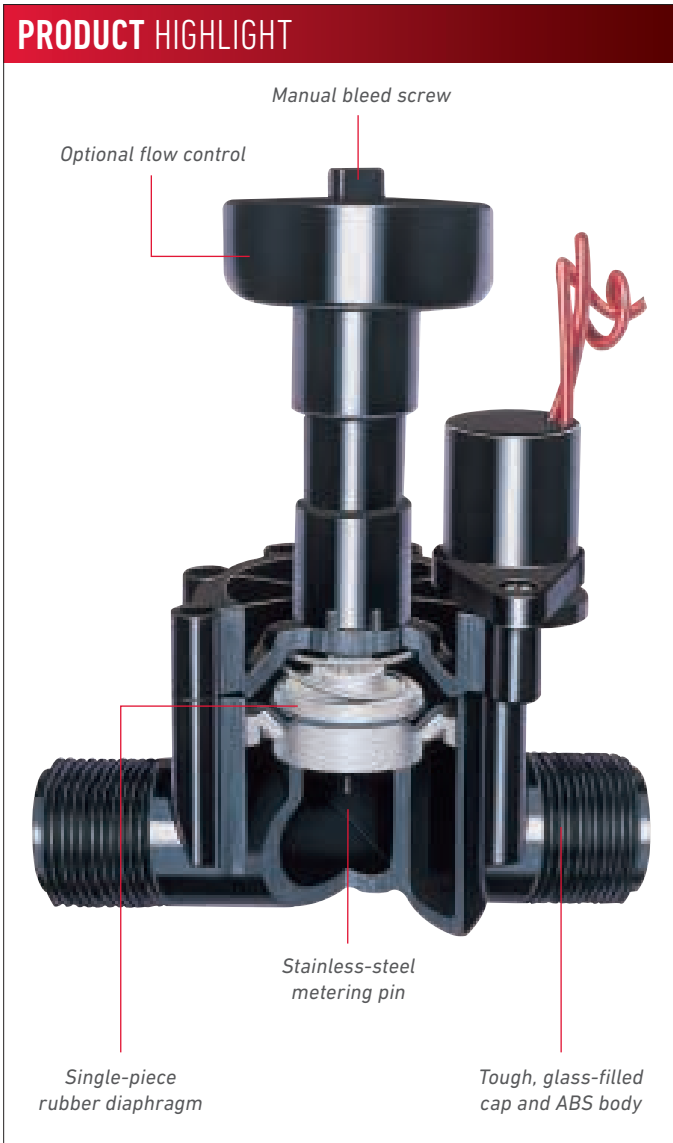

254/264 SERIES PRESSURE LOSS DATA

Size	Model	gpm Flow											
		0.5	1	2	5	10	15	20	25	30	35	40	45
3/4"	Electric	<1.0	<1.0	<1.0	1.5	3.0	6.5						
1"	Electric				2.0	2.0	2.3	3.1	4.0	5.4	7.0	8.7	10.5

Note: For optimum sprinkler performance when designing a system, calculate total Pressure Loss to ensure sufficient downstream pressure. Flow rates are recommended not to exceed 5 psi loss.

250/260 SERIES PRESSURE LOSS DATA

Size	Model	gpm Flow						
		0.5	10	15	20	25	30	40
1"	Hydraulic	<1.0	1.0	2.0	3.0	4.0	6.0	9.5
1"	Electric		4.4	4.5	5.0	5.0	7.0	9.5

250/260 SERIES MODEL LIST

Model	Description
FEMALE THREADS	
250-06-04	1" Female NPT, In-line, with Flow Control
260-06-04	1" Female NPT, In-line, without Flow Control
250-00-04	1" Female NPT, In-line, Pin-type Hydraulic, with Flow Control
250-01-04	1" Female NPT, In-line, Normally Open Hydraulic, with Flow Control
MALE THREADS	
264-06-03	3/4" Male Thread x Male Thread, In-Line, without Flow Control
254-06-04	1" Male Thread x Male Thread, In-Line, with Flow Control
264-06-04	1" Male Thread x Male Thread, In-Line, without Flow Control
254-16-04	1" Male Thread x Barbed Insert, In-Line, with Flow Control
264-16-04	1" Male Thread x Barbed Insert, In-Line, without Flow Control

Specifying Information—250/260 Series Valves (Female)

2X0-0X-04		
Flow Control	Activation Type	Size
2X0	0X	04
5—with Flow Control 6—without Flow Control	0—Pin-type Hydraulic 1—Normally Open Hydraulic 6—Electric	04—1"
Example: A 1" 250 Series Valve with flow control and electric activation would be specified as: 250-06-04		

Specifying Information—254/264 Series Valve (Male)

2X4-X6-0X		
Flow Control	Body Style	Size
2X4	X6	0X
5—with Flow Control 6—without Flow Control	0—Male Thread x Male Thread 1—Male Thread x Barbed Insert	3—3/4" 4—1"
Example: A 1" electric 264 Series Valve without flow control with a barb would be specified as: 264-16-04		

Irritrol

2500 SERIES VALVES

FEATURES & BENEFITS

Patented "Floating" Metering System

Tolerates dirty water and allows for consistent operation.

High-Flow, Low Friction Loss Design Combined with Low-flow Capability

Can handle a wide range of applications.

Rugged, Double-beaded EPDM Diaphragm

Ensures a leak-proof seal.

Internal or External Bleed (Flash mode)

Allows for manual operation.

Heavy-duty, Corrosion and UV-resistant PVC and Stainless Steel Construction

Proven durability.

Available in Female and NPT or Slip Configurations (No male pipe adapter required)

Will handle all regional installation variances.

Self-aligning Bonnet

Permits fast and easy servicing without removal from the system.

Additional Features

- ✓ Buna-N valve seat seal
- ✓ Floating bleed tube allows thermal expansion without affecting performance
- ✓ Encapsulated injection-molded solenoid with a captive hex plunger



2500S



2500SF



2500T



2500TF

SPECIFICATIONS

Operating

- Flow range: .25-30 GPM
- Pressure range: 10-150 ps

Warranty

- Five years

Dimensions

- 2500: H: 5½", W: 2¾", L: 5"
- 2507: H: 5½", W: 2¾", L: 5"

Electrical

- Solenoid: 24 V AC
- Inrush volt-amp: 24 V AC-9.6 VA
- Inrush current: .4 amp
- Holding volt-amp: 24 V AC-4.8 VA
- Holding current: .2 amp

PRODUCT HIGHLIGHT

IDEAL FOR DIRTY WATER APPLICATIONS

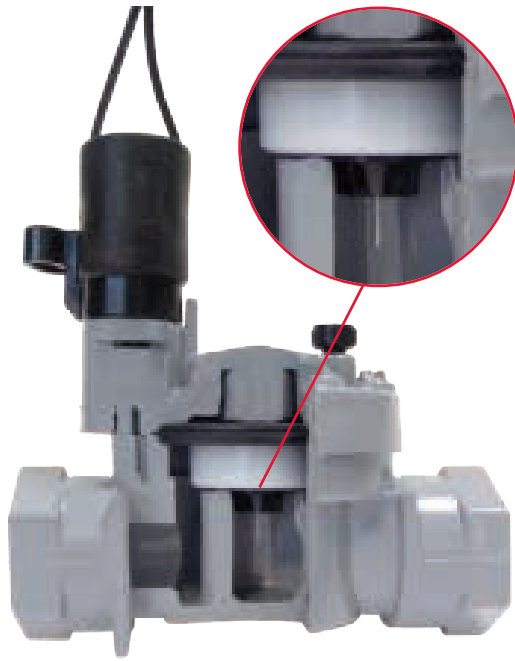

Debris-tolerant, patented "floating metering system" makes this valve ideal for wells & dirty water applications

2500 SERIES VALVES MODEL LIST

Model	Description
2500S	1" slip connection
2500SF	1" slip connection with flow control
2500T	1" NPT threaded connection
2500TF	1" NPT threaded connection with flow control
2507TF	¾" NPT threaded connection with flow control

OPTIONAL ACCESSORIES



Recycled-water Solenoid Kit (RW60-KIT)
purple solenoid with purple warning tag



DC Latching Solenoid (DCL)
Note: Maximum pressure for a valve that utilizes latching solenoid is 120 psi

2500 SERIES VALVES PRESSURE LOSS DATA

Model	Size	gpm Flow						
		.25	2	5	10	15	20	30
2500 Series	1"	5.40	3.82	3.00	2.20	1.90	3.10	5.10
2507 Series	¾"	2.75	3.40	3.85	4.00	2.40	3.98	6.19

1) Pressure loss data derived from valves independently tested by CIT (Fresno, CA)

2) See pressure loss charts on pages 169 though 188 for details

Specifying Information – 2500 Series Valves

XXXX-X-X		
Model	Configuration	Feature
2500	X	X
2500 angle valve	S - Slip Connection T - NPT Threads	F = Flow Control
Example: A 2500 globe valve with NPT threads and flow control = 2500TF		

Specifying Information – 2507 Series Valves

XXXX-X-X		
Model	Configuration	Feature
2507	X	X
2507 globe valve	T - NPT Threads	F = Flow Control
Example: A ¾" 2507 globe valve with NPT threads and flow control = 2507TF		

Irritrol

2700 SERIES VALVES

FEATURES & BENEFITS

Rugged, Double-beaded EPDM Diaphragm

Ensures a leak-proof seal

Internal and External Bleed (Flush mode)

Allows for manual operation

Full Stainless-steel Metering System

(DPR models)

Consistent valve operation

Patented "Floating Metering System"

(APR models)

Consistent valve operation

Heavy-duty, Corrosion- and UV-Resistant

PVC, Glass-filled Polypropylene (DPR

models only) and Stainless Steel

Construction

Durable, long-term performance

Self-aligning Bonnet with Captured Hex/ Phillips Screws

Permits fast and easy servicing without removal from the system (APR models)

Threaded Bonnet Design

Allows easy servicing without removal from the system (DPR models)

Patented, Tamper-resistant Flow Control Mechanism

Allows for precise water flow (DPR models)

Additional Features

- ✓ Buna-N valve seat seal
- ✓ Flow control for precise adjustment and manual shutoff
- ✓ Gravity-type anti-siphon poppet
- ✓ Removable, ergonomic, tamper-resistant flowcontrol handle (APR models)
- ✓ Female threaded connections only

2706PR



2711DPR



2713APR



SPECIFICATIONS

Operating

- Flow range: .25-30 GPM
- Pressure range: 10-150 ps

Warranty

- Five years

Dimensions

- 2706: H: 4 $\frac{7}{8}$ ", W: 2 $\frac{5}{8}$ ", L: 5 $\frac{3}{4}$ "
- 2709: H: 5 $\frac{1}{16}$ ", W: 3 $\frac{1}{8}$ ", L: 6 $\frac{1}{4}$ "
- 2711: H: 5 $\frac{5}{8}$ ", W: 3", L: 6 $\frac{1}{4}$ "
- 2713: H: 6", W: 3", L: 6 $\frac{7}{8}$ "

Electrical

- Solenoid: 24 V AC
- Inrush volt-amp: 24 V AC-9.6 VA
- Inrush current: .4 amp
- Holding volt-amp: 24 V AC-4.8 VA
- Holding current: .2 amp

PRODUCT HIGHLIGHT

DOUBLE-BEADED DIAPHRAGM



A double-beaded EPDM diaphragm gives you the security that your valve will continue to operate without leaks, time after time.

2700 SERIES VALVES MODEL LIST

Model	Description
2711APR	$\frac{3}{4}$ " electric, flow control, stainless screw bonnet
2713APR	1" electric, flow control, stainless screw bonnet
2711DPR	$\frac{3}{4}$ " electric, flow control, threaded bonnet
2713DPR	1" electric, flow control, threaded bonnet
2706PR	$\frac{3}{4}$ " manual
2709PR	1" manual

OPTIONAL ACCESSORIES

<p>Recycled-water Solenoid Kit (RW60-KIT) purple solenoid with purple warning tag</p>	<p>DC Latching Solenoid (DCL) Note: Maximum pressure for a valve that utilizes latching solenoid is 120 psi</p>
<p>Threaded Bonnet Wrench (2400-45)</p>	

** Optional accessories are field-installable. Must specify separately if required.

2700 SERIES VALVES PRESSURE LOSS DATA

Model	Size	gpm Flow				
		5	10	15	20	25
2706PR	$\frac{3}{4}$ "	1	3	5		
2709PR	1"	1	1	2	4	6

- 1) Pressure loss data derived from valves independently tested by CIT (Fresno, CA)
- 2) See pressure loss charts on pages 169 though 188 for details

Specifying Information – 2700 Series Valves

XXX-X-X		
Model	Size	Type
270	X	X
2700 manual valve	6 - $\frac{3}{4}$ " size 9 - 1" size	PR - anti-siphon
Example: A 2700 manual $\frac{3}{4}$ " anti-siphon valve = 2706PR		

2711 SERIES VALVES PRESSURE LOSS DATA

Model	Size	gpm Flow						
		.25	2	5	10	15	20	30
2711APR & DPR	$\frac{3}{4}$ "	5.0	5.8	4.14	4.11	4.72	7.60	
2713APR & DPR	1"	5.0	5.5	2.03	3.10	2.22	3.72	8.01

- 1) Pressure loss data derived from valves independently tested by CIT (Fresno, CA)
- 2) See pressure loss charts on pages 169 though 188 for details

Specifying Information – 2711 Series Valves

XXX-X-X			
Model	Size	Option	Type
271	X	X	X
2711 electric valve	T - NPT Threads	A - stainless screws D - threaded bonnet	PR - anti-siphon
Example: A 2700 electric 1" anti-siphon valve with stainless screws = 2713APR			

Note: Anti-siphon valve to be mounted above ground at least 6" above highest sprinkler head (consult local codes).

Irritrol

311 SERIES VALVES

FEATURES & BENEFITS

Upper Body and Air-vent Cap Construction of Glass-Filled Nylon

Provides long-term performance.

Rugged, Double-beaded Nylon Reinforced EPDM Diaphragm

Ensures a leak-proof seal.

Internal and External Bleed (Flush mode)

Manual operation.

Accepts OmniReg® Modular Pressure Regulator

Ensures consistent performance.

Externally Removable Self-cleaning Metering System

Ensures consistent performance in recycled-water applications.

Additional Features

- ✓ Unique three-way stainless steel bonnet screws with threaded-brass inserts
- ✓ Encapsulated injection-molded solenoid with a captive hex plunger
- ✓ Buna-N valve seat seal
- ✓ Female threaded connections only



311A-.75



311A-1

SPECIFICATIONS

Operating

- Flow range: 1-30 GPM
- Pressure range: 10-150 psi
- Operating temperature: up to 120° F

Warranty

- Five years

Dimensions

- 311A-.75: H: 8½", W: 3¾", L: 6"
- 311A-1: H: 8½", W: 3¾", L: 6"

Electrical

- Solenoid: 24 V AC
- Inrush volt-amp: 24 V AC-9.6 VA
- Inrush current: .4 amp
- Holding volt-amp: 24 V AC-4.8 VA
- Holding current: .2 amp

PRODUCT HIGHLIGHT

PREMIER ANTI-SIPHON VALVES



311 SERIES VALVES MODEL LIST

Model	Description
311A-.75	¾" flow control, internal bleed
311A-1	1" flow control, internal bleed

OPTIONAL ACCESSORIES

 <p>Recycled-water Solenoid Kit (RW60-KIT) purple solenoid with purple warning tag</p>	 <p>DC Latching Solenoid (DCL) Note: Maximum pressure for a valve that utilizes latching solenoid is 120 psi</p>
---	--



OmniReg® Regulator (OMR-30 or OMR-100)

** Optional accessories are field-installable. Must specify separately if required.

Specifying Information – 311 Series Valves

XXXX-XX	
Model	Size
311A	X
311 electric anti-siphon valve	.75 - ¾" size 1 - 1" size
Example: A 311 electric anti-siphon 1" valve = 311A-1	

311 SERIES VALVES PRESSURE LOSS DATA

Model	Size	gpm Flow						
		1	5	10	15	20	25	30
311A-.75	¾"	5.5	6.0	8.0	9.0	11.0		
311A-1	1"	5.5	6.0	7.5	8.5	10.0	13.0	18.5

1) Pressure loss data derived from valves independently tested by CIT (Fresno, CA)

2) See pressure loss charts on pages 169 though 188 for details

Irritrol

2623DPR/300 SERIES VALVES

FEATURES & BENEFITS

2623DPR SERIES

Converts Champion® Brass Anti-siphon Valves to Electric Operation

Automatic system function.

Internal and External Bleed (Flush mode)

Allows for manual operation.

Rugged, Double-beaded Santoprene® Diaphragm

Provides a leak-proof seal.

Heavy-duty, Corrosion- and UV-resistant PVC and Stainless Steel Construction

For long-term reliability.

300 SERIES

Converts ¾-inch and 1-inch Champion Brass Anti-siphon Valves (models 300-.75 and 300-1) and 1-inch Irritrol Manual Valves to Electric Operation

Automatic system function.

Internal and External Bleed (Flush mode)

Allows for manual operation.

Rugged, Double-Beaded Nylon-Reinforced Buna-N Diaphragm

Provides a leak-proof seal.

Externally Removable Self-Cleaning Metering System

Ensures consistent performance in recycled-water applications.

Tough, Glass-Reinforced Nylon, Stainless Steel and Brass Construction

Provides proven durability.



2623DPR-1



300-.75

Additional Features

- ✓ Ergonomic flow control allows precise flow adjustment and manual shut-off
- ✓ Buna-N valve seat seal
- ✓ Encapsulated injection-molded solenoid with a captive hex plunger
- ✓ Accepts OmniReg® modular pressure regulator

SPECIFICATIONS

Operating

- Pressure range: 10-150 psi

Warranty

- Five years

Dimensions

- 2623DPR Series: H: 6³/₄", W: 2⁷/₈"
- 300 Series: H: 7¹/₄", W: 4"

Electrical

- Solenoid: 24 V AC
- Inrush volt-amp: 24 V AC-9.6 VA
- Inrush current: .4 amp
- Holding volt-amp: 24 V AC-4.8 VA
- Holding current: .2 amp

PRODUCT HIGHLIGHT

SINGLE PIECE ADAPTERS MAKE CONVERSIONS EASY

Internal and external bleed for manual operation



Externally removable self-cleaning metering system ensures consistent operation

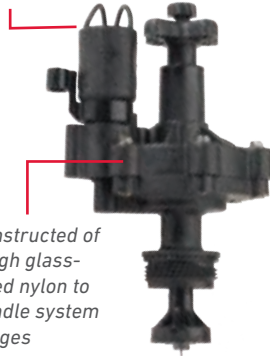

Constructed of tough glass-filled nylon to handle system surges

Specifying Information – 2623DPR Series Valves

XXXX-XX

Model	Size
2623DPR	XX
2623DPR PVC valve adapter	.75 - ¾" size 1 - 1" size

Example: A 2623DPR, 1" PVC valve adapter = **2623DPR-1**

Specifying Information – 300 Series Valves

XXXX-XX

Model	Size
300	XX
300 glass-reinforced nylon valve adapter	.75 - ¾" size 1 - 1" size

Example: A 300, 1" glass-reinforced nylon valve adapter = **300-1**

Note: Anti-siphon valve to be mounted above ground at least 6" above highest sprinkler head (consult local codes).

2623DPR SERIES VALVES MODEL LIST

Model	Description
2623DPR-.75	¾" PVC valve adapter
2623DPR-1	1" PVC valve adapter

300 SERIES VALVES MODEL LIST

Model	Description
300-.75	¾" glass-reinforced nylon valve adapter
300-1	1" glass-reinforced nylon valve adapter

OPTIONAL ACCESSORIES



Recycled-water Solenoid Kit (RW60-KIT)
purple solenoid with purple warning tag



DC Latching Solenoid (DCL)
Note: Maximum pressure for a valve that utilizes latching solenoid is 120 psi



OmniReg® Regulator (OMR-30 or OMR-100)

** Optional accessories are field-installable. Must specify separately if required.



700 SERIES VALVES

FEATURES & BENEFITS

Unique Straight-Through Flow Path

Minimal pressure loss for greater efficiency

Slow-Closing Design

Reduces water hammer and resulting stress on the system

Tough Glass-Reinforced Nylon, Stainless Steel and Brass Construction

Provides durability and long life

High and Low-Flow Operation

Ensures consistent performance in a variety of applications

Self-Flushing, 150-Mesh, Stainless Steel Filter Screen On 1-, 1½- and 2-Inch Models

Provides consistent operation

Additional Features

- ✓ Internal and external bleed (flush mode)
- ✓ Wide flow range
- ✓ Flow control allows precise flow adjustment and manual shutoff (not available on ¾-inch model)
- ✓ Compact, low-profile design
- ✓ Rugged nylon-reinforced Buna-N diaphragm provides leak-proof seal
- ✓ EPDM seat seal
- ✓ Encapsulated injection-molded solenoid with a captive hex plunger
- ✓ Unique three-way stainless steel bonnet screws with threaded brass inserts accept Phillips, flat-blade and hex-driver tools



Specifying Information – 700 Series Valves

XXX-XXX	
Model	Size
700	XX
700 UltraFlow electric valve	B-.75 - ¾" size 1 - 1" size 1.5 - 1½" size 2 - 2" size
Example: A 700 UltraFlow electric 1" valve = 700-1	

700 SERIES VALVES PRESSURE LOSS DATA

Model	Size	gpm Flow								
		0.1	2	5	10	15	20	30	40	50
700B-.75	¾"	0.38	0.38	0.86	1.22	2.03v	3.27	6.75		
700-1	1"	2.20	1.59	1.80	2.41	2.23	1.84	3.22	5.58	8.59

1) Pressure loss data derived from valves independently tested by CIT (Fresno, CA)

2) See pressure loss charts on pages 169 though 188 for details

SPECIFICATIONS

Operating

- Flow range: 0.1-180 GPM
(700B-.75 & 700-1 can operate at .1 GPM)
(700-1.5 not recommended under 25 psi)
- Pressure range: 10-150 psf
(700-2 not recommended under 25 psi)

Dimensions

- 700B-.75: H: 4½", W: 1⅞", D: 3¾"
- 700-1: H: 4½", W: 3", D: 4⅜"
- 700-1.5: H: 5½", W: 4⅜", D: 6¼"
- 700-2: H: 7", W: 5½", D: 8"

Warranty

- Five years

Electrical

- Solenoid: 24 V AC
- Inrush volt-amp: 24 V AC-9.6 VA
- Inrush current: .4 amp
- Holding volt-amp: 24 V AC-4.8 VA
- Holding current: .2 amp

PRODUCT HIGHLIGHT

ULTRAFLOW® TECHNOLOGY



Straight-through flow path provides a wide flow range with minimal friction loss

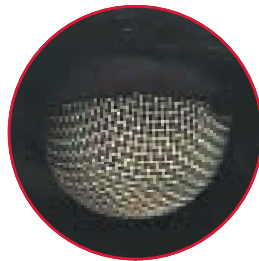

Self-flushing, 150 mesh stainless steel filter screen provides consistent operation

PATENTED TECHNOLOGY

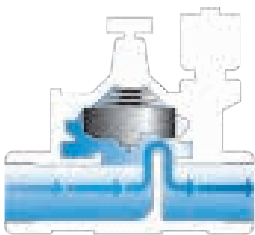

Conventional flow path



The UltraFlow Series straight-through flow path

700 SERIES VALVES MODEL LIST

Model	Description
700B-.75	¾" internal bleed flow control
700-1	1" internal bleed flow control
700-1.5	1½" internal bleed flow control
700-2	2" internal bleed flow control

OPTIONAL ACCESSORIES



Recycled-water Solenoid Kit (RW60-KIT)
purple solenoid with purple warning tag



DC Latching Solenoid (DCL)
Note: Maximum pressure for a valve that utilizes latching solenoid is 120 psi



OmniReg® Regulator (OMR-30 or OMR-100)

** Optional accessories are field-installable. Must specify separately if required.

700 SERIES VALVES PRESSURE LOSS DATA

Model	Size	gpm Flow											
		15	20	30	40	50	60	80	100	120	140	160	180
700-1.5	1 ½"	0.19	0.36	0.69	1.13	1.49	2.13	3.85	6.06	8.72	11.89		
700-2	2"			0.64	0.83	0.98	1.17	2.07	3.06	3.96	5.21	6.50	8.23

1) Pressure loss data derived from valves independently tested by CIT (Fresno, CA)

Irritrol

200B SERIES VALVES

FEATURES & BENEFITS

Heavy-Duty, Corrosion and UV-Resistant PVC Construction with Stainless Steel Spring and Hardware

Provides consistent operation.

Slow Closing Design.

Reduces water hammer and resulting stress on the system

Rugged, Double-Beaded Chemical Resistance Diaphragm

Ensures a leak-proof seal.

Internal and External Bleed (Flush Mode)

Allows for manual operation.

Accepts Omnireg® Modular Pressure Regulator

Ensures consistent performance.

High-Strength Ribbed Bonnet and Bottom Inlet

Increases durability.

Three-Way Stainless Steel Screws

Screws accept Phillips, flat-blade and hex-driver tools for easy servicing without removal from the system.

Additional Features

- ✓ Flow control allows precise adjustment and manual shutoff
- ✓ Buna-N valve seat seal
- ✓ Unique threaded inlet plug O-ring seal prevents leaks
- ✓ Encapsulated injection-molded solenoid with a captive hex plunger



SPECIFICATIONS

Operating

- Flow range: 5-120 GPM
- Pressure range: 20-150 psi

Warranty

- Five years

Dimensions

- 214B: H: 6½", W: 2½", L: 4½"
- 216B: H: 7¾", W: 4¼", L: 5½"
- 217B: H: 8¾", W: 5¾", L: 6¼"

Electrical

- Solenoid: 24 V AC
- Inrush volt-amp: 24 V AC-9.6 VA
- Inrush current: .4 amp
- Holding volt-amp: 24 V AC-4.8 VA
- Holding current: .2 amp

PRODUCT HIGHLIGHT

DURABLE HEAVY-DUTY CONSTRUCTION

Rugged, double-beaded diaphragm ensures a leak-proof seal

High strength ribbed bonnet increases durability

Bottom inlet plug & O-ring seal make this valve easy to convert from globe to angle

Extra thick PVC construction means long life

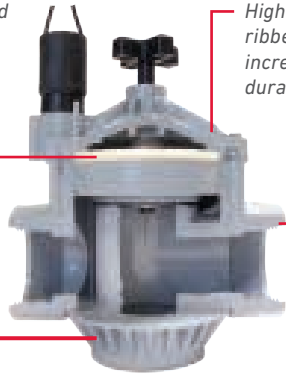

200B SERIES VALVES MODEL LIST

Model	Description
214B	1" NPT threads, flow control
16B	1½" NPT threads, flow control
217B	2" NPT threads, flow control

OPTIONAL ACCESSORIES



Recycled-water Solenoid Kit (RW60-KIT)
purple solenoid with purple warning tag



DC Latching Solenoid (DCL)
Note: Maximum pressure for a valve that utilizes latching solenoid is 120 psi



OmniReg® Regulator (OMR-30 or OMR-100)

Specifying Information – 200B Series Valves

XXXX-XX	
Model	Size
200B	XX
21 - 200B Series electric valve	4 - 1" size 6 - 1½" size 7 - 2" size

Example: A 200B Series 1" electric valve = **214B**

** Optional accessories are field-installable. Must specify separately if required.

700 SERIES VALVES PRESSURE LOSS DATA

Model	Size	Globe Angle	gpm Flow										
			20	30	40	50	60	80	100	120	140	160	180
214B	1"	G	3.36	2.60	1.82	2.35	5.40						
		A	3.09	2.20	1.48	1.98	4.00						
216B	1½"	G				3.04	2.66	2.33	2.97	4.14	5.62		
		A				2.76	2.24	1.99	2.30	3.10	4.42		
217B	2"	G				2.00	1.93	1.73	1.55	1.68	2.99	4.85	6.31
		A				2.00	1.93	1.73	1.55	1.59	2.15	3.27	4.88

1) Pressure loss data derived from valves independently tested by CIT (Fresno, CA)

2) See pressure loss charts on pages 169 though 188 for details

TORO.

252 SERIES VALVES

FEATURES & BENEFITS

Heavy-Duty Toro Solenoid

Provides dependable operation and long life.

Fabric-Reinforced Rubber Diaphragm

Provides long-term resistance to tears and stretching.

Flow Control Handle

Adjusts the flow of each zone on a system.

Robust ABS Body Material and Durable Glass-Filled Cap

Ensures the valve can withstand high pressures and flows without compromise.



Effluent
Options
Available

Additional Features

- ✓ 24" lead solenoid wires on 1 1/2" and 2" models, 18" lead wires 1" models
- ✓ Self-cleaning, stainless steel metering pin (electric)
- ✓ Tough, glass-filled bonnet
- ✓ Single-piece diaphragm



SPECIFICATIONS

Operational

- Recommended Flow Range:
 - 1": 5.0 to 40 gpm
 - 1½": 25 to 120 gpm
 - 2": 60 to 180 gpm
- Operating Pressure: 20 to 150 psi
- Solenoid: 24 Vac, 50/60 Hz
 - Inrush: 0.30 amps, 7.20 Vac
 - Holding: 0.20 amps, 4.80 Vac
- Burst pressure safety rating: 380 psi

Dimensions

- 1": 6¾" H x 4½" W
- 1½": 7¾" H x 6" W
- 2": 9½" H x 7" W

Warranty

- Two years

PRODUCT HIGHLIGHT



External Bleed

The external bleed allows manual operation of the valve without electrically charging the solenoid. System flushing can also be accomplished using the external bleed with debris and other material being flushed out of the port.



Combination Globe and Angle Valve

The all-in-one globe and angle configuration allows flexibility in design and installation. Angle installations allow for less pressure loss across the piping system, while globe configurations are standard in many irrigation systems.

252 SERIES PRESSURE LOSS DATA

Size	Type	Config.	gpm Flow												
			5	10	20	25	30	40	50	60	70	80	100	120	150
1½"	Hydraulic	Globe				1.0	1.0	2.0	3.0	4.0	5.5	6.5			
		Angle				1.0	1.0	1.5	1.5	3.0	4.0	5.0			
2"	Hydraulic	Globe								1.5	2.0	2.0	3.5	5.0	8.0
		Angle								1.0	1.0	1.5	2.0	3.0	5.0
1"	Electric	Globe	3.0	4.0	5.0	6.0	7.0	9.5							
		Angle	2.0	3.5	4.5	4.5	5.0	7.5							
1½"	Electric	Globe				1.5	1.0	2.0	3.0	4.0	5.0	7.0			
		Angle				1.5	1.0	1.5	2.0	3.0	3.0	5.0			
2"	Electric	Globe								2.0	2.0	2.5	3.5	5.5	8.0
		Angle								1.0	1.0	2.0	3.0	4.0	5.0

Note: For optimum performance when designing a system, be sure to calculate total Pressure Loss to ensure sufficient downstream pressure. For optimum regulation performance, size regulating valves toward the higher flow ranges. Flow rates are recommended not to exceed 5 psi loss. = Debris-resistant models

252 SERIES MODEL LIST

Model	Description
FEMALE NPT GLOBE/ANGLE WITH FLOW CONTROL	
252-06-04	1"
252-26-06	1½"
252-26-08	2"
252-21-06	1½" Normally Open
252-21-08	2" Normally Open

Specifying Information—252 Series Valves

252-XX-0X		
Model	Activation Type	Size
252	XX	0X
252—252 Series Valve	06—1" Electric 21—Normally Open Hydraulic 26—1½" or 2" Electric	4—1" 6—1½" 8—2"

Example: A 1½" electric 252 Series Valve, would be specified as: **252-26-06**

Note: DC Latching Solenoid not available.



100 SERIES VALVES

FEATURES & BENEFITS

Tough, Glass-reinforced Nylon, Stainless Steel and Brass Construction

Withstands high temperatures and system surges under pressure for long-term reliability.

220 PSI Pressure Rating

Prevents water hammer and system damage in high-pressure installations.

Internal and External Bleed (Flush mode)

Manual operation.

Externally Removable Self-cleaning Metering System

Provides consistent performance in recycled-water applications.

Accepts OmniReg® Modular Pressure Regulator

Ensures consistent performance.

102 ANTI-CONTAMINATION MODELS*

150-Mesh External Control Water Filter and Three-way solenoid

Provides non-continuous metering for recycled water applications.

Selectable Normally Open or Normally Closed Mode (Factory set at normally closed)

Provides flexibility (102 only).

Control Water Filter

Allows easy external service.



100P3N



100P2



100P1.5



100P1

Master Valve Tip:
Configure on-the-fly
NC or NO

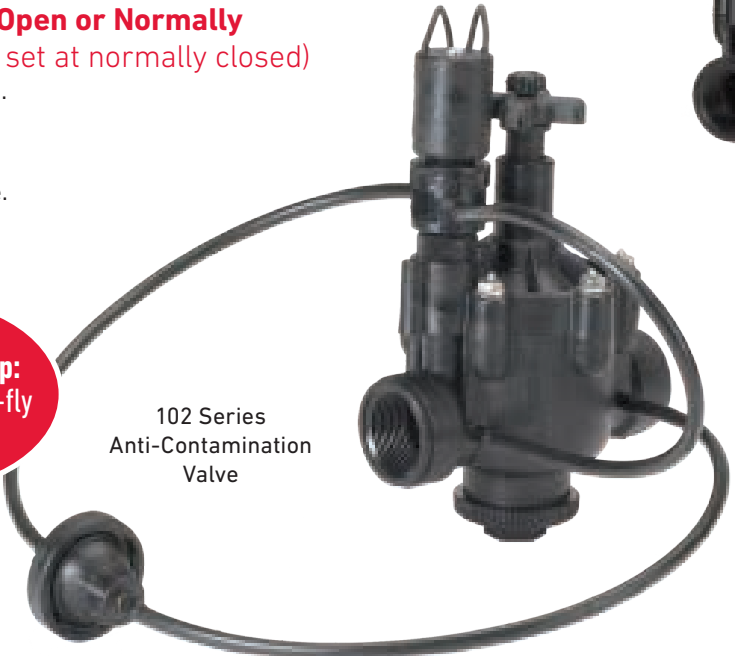

102 Series
Anti-Contamination
Valve

SPECIFICATIONS

Operating

- Flow range: 5-300 GPM
- Pressure range: 20-220 psi
20-100 psi (102 models)

Warranty

- Five year

Dimensions

- 100P1: H: 6¾", W: 3⁵/₈", D: 4¾"
- 102P1: H: 7½", W: 5", D: 4¾"
- 100P1.5: H: 7¼", W: 3", D: 4¾"
- 102P1.5: H: 7½", W: 5", D: 4¾"
- 100P2: H: 9½", W: 6¹/₈", D: 7¾"
- 102P2: H: 10¼", W: 7½", D: 7¾"
- 100P3: H: 10¾", W: 6¹/₈", D: 8¼"
- 102P3: H: 11½", W: 7½", D: 8½"

Electrical

- Solenoid: 24 V AC
- Inrush volt-amp: 24 V AC-9.6 VA
- Inrush current: .4 amp
- Holding volt-amp: 24 V AC-4.8 VA
- Holding current: .2 amp

100 SERIES VALVES MODEL LIST

Model	Description
100P1	1" NPT threads, flow control
100P1.5	½" internal bleed, flow control
100P2	2" internal bleed, flow control
100P3N	3" internal bleed, flow control
102P1	1" anti-contamination filter
102P1.5	1½" anti-contamination filter
102P2	2" anti-contamination filter
102P3N	3" anti-contamination filter

100 SERIES VALVES PRESSURE LOSS DATA

Model	Size	Globe Angle	gpm Flow						
			5	10	20	30	40	50	
100P1	1"	G	6.30	4.20	3.20	4.10	7.20	10.90	
102P1		A	6.30	4.20	3.10	2.70	4.80	7.90	

Model	Size	Globe Angle	gpm Flow								
			30	40	50	60	70	80	90	100	110
100P1.5	1.5"	G	1.60	2.30	3.60	5.20	7.00	9.20	11.70	14.40	17.50
102P1.5		A	1.30	1.60	2.80	4.00	5.50	7.10	9.00	11.00	13.30

Model	Size	Globe Angle	gpm Flow								
			80	90	100	110	120	130	140	150	175
100P2	2"	G	1.60	2.30	3.60	5.20	7.00	9.20	11.70	14.40	17.50
102P2		A	1.30	1.60	2.80	4.00	5.50	7.10	9.00	11.00	13.30

Model	Size	Globe Angle	gpm Flow						
			150	175	200	225	250	275	300
100P3N	3"	G	2.50	3.00	4.10	5.30	6.70	8.30	10.10
102P3N		A	1.90	2.40	3.30	4.30	5.50	6.90	8.50

OPTIONAL ACCESSORIES

 <p>Recycled-water Solenoid Kit (RW60-KIT) purple solenoid with purple warning tag</p>	 <p>DC Latching Solenoid (DCL) Note: Maximum pressure for a valve that utilizes latching solenoid is 120 psi</p>
 <p>OmniReg® Regulator (OMR-30 or OMR-100)</p>	 <p>Scrubber diaphragm assembly (100P-S-KIT)</p>
 <p>Richdel® Century valve repair kit (R100PX)</p>	 <p>IW series repair kit (SPK-100-X)</p>

** Optional accessories are field-installable. Must specify separately if required.

Specifying Information – 100 Series Valves

10XP-XX	
Model	Size
100	XX
100P - 100 internal bleed and flow control valve	1 - 1" size 1.5 - 1½" size
102P - 102 anti-contamination filter valve	2 - 2" size 3N - 3" size
Example: A 100P 1" valve with internal bleed and flow control = 100P1	

1) Pressure loss data derived from valves independently tested by CIT (Fresno, CA)

2) See pressure loss charts on pages 169 though 188 for details.



100-S SERIES VALVES

FEATURES & BENEFITS

Innovative Continuous Scrubbing Feature

Actively cleans the metering device for consistent valve operation.

Tough, Glass-reinforced Nylon, Stainless Steel and Brass Construction

Withstands high temperatures and system surges under pressure for long-term reliability.

Fabric-reinforced EPDM Diaphragm and EPDM Seat Seal

Designed to operate in virtually all water applications.

Rugged Internal Plastic and Stainless Steel Parts

Scrubber fan, nut and metering system chlorine and chemical resistant.

Completely Serviceable and Retrofittable

Diaphragm assembly may be replaced or retrofitted to previous models.

220 PSI Pressure Rating

Prevents water hammer and system damage in high-pressure installations.

Internal and External Bleed (flush mode)

Manual operation.

Externally Removable Self-Cleaning Metering System

Provides consistent performance in recycled-water applications.

Accepts OmniReg® Modular Pressure Regulator

Ensures consistent performance.



100P3N-S



100P2-S



100P1.5-S



100P1-S

Specifying Information – 100 Series Valves

100P-X-S-X		
Model	Size	Kit
100P	X-S	X
100 internal bleed and flow control valve	1 - 1" size 1.5 - 1½" size 2 - 2" size 3N - 3" size	Kit
Example: A 100P 2" scrubber valve with internal bleed and flow control = 100P3N		

SPECIFICATIONS

Operating

- Flow range: 5-300 GPM
- Pressure range: 20-220 psi
20-100 psi (102 models)

Warranty

- Five years

Dimensions

- 100P1-S: H: 6¾", W: 3½", D: 4¾"
- 100P1.5-S: H: 7¼", W: 3½", D: 4¾"
- 100P2-S: H: 9½", W: 6½", D: 7¾"
- 100P3-S: H: 10¾", W: 6½", D: 8¼"

Electrical

- Solenoid: 24 V AC
- Inrush volt-amp: 24 V AC-9.6 VA
- Inrush current: .4 amp
- Holding volt-amp: 24 V AC-4.8 VA
- Holding current: .2 amp

PRODUCT HIGHLIGHT

Self-cleaning—each cycle cleans internal orifices. All parts are easily accessible without removing the valve from the system



Continuous scrubbing turbine actively cleans the metering device for consistent valve operation in dirty water applications

OPTIONAL ACCESSORIES

 <p>Recycled-water Solenoid Kit (RW60-KIT) purple solenoid with purple warning tag</p>	 <p>DC Latching Solenoid (DCL) Note: Maximum pressure for a valve that utilizes latching solenoid is 120 psi</p>
 <p>OmniReg® Regulator (OMR-30 or OMR-100)</p>	 <p>Scrubber diaphragm assembly (100P-S-KIT)</p>

** Optional accessories are field-installable. Must specify separately if required.

100-S SERIES VALVES PRESSURE LOSS DATA

Model	Size	Globe Angle	gpm Flow						
			5	10	20	25	30	40	50
100P1-S	1"	A	4.35	4.97	2.51	3.61	5.21	9.06	13.49
		G	1.90	2.40	3.30	4.30	5.50	6.90	8.50

Model	Size	Globe Angle	gpm Flow									
			20	30	40	50	60	70	80	90	100	110
100P1.5-S	1.5"	A	0.92	1.33	2.33	5.53	4.93	6.64	8.99	11.20	13.50	16.62
		G	0.95	1.35	2.65	3.99	5.84	7.89	10.22	13.03	16.12	19.82

Model	Size	Globe Angle	gpm Flow								
			80	90	100	110	120	130	140	150	175
100P2-S	2"	A	2.80	3.80	4.50	5.50	6.30	7.60	8.70	10.30	13.10
		G	3.54	4.45	5.40	6.68	8.04	9.26	10.95	12.21	15.65

Model	Size	Globe Angle	gpm Flow						
			150	175	200	225	250	275	300
100P3N-S	3"	A	2.55	3.10	4.50	5.40	7.10	8.40	10.15
		G	2.97	4.04	5.37	6.35	7.99	9.35	11.26

100-S SERIES VALVES MODEL LIST

Model	Description
100P1-S	1" internal bleed, scrubber valve
100P1.5-S	1½" internal bleed, scrubber valve
100P2-S	2" internal bleed, scrubber valve
100P3N-S	3" internal bleed, scrubber valve
100P1-S	1" scrubber diaphragm kit
100P1.5-S-KIT	1½" scrubber diaphragm kit
100P2-S-KIT	2" scrubber diaphragm kit
100P3N-S-KIT	3" scrubber diaphragm kit

1) Pressure loss data derived from valves independently tested by CIT (Fresno, CA)

2) See pressure loss charts on pages 169 through 188 for details.

TORO.

P-220 SERIES VALVES

FEATURES & BENEFITS

Durable Glass-Filled Nylon

Ensures the P-220 can operate at pressures up to 220 psi.

Precise Pressure Control Option

Compact EZReg® dial-design technology can be factory or field installed and does not require the removal of the solenoid.

External Manual Bleed

Keeps valve box dry and easy to use.

Standard Schrader Valve at Outlet

Simple verification of downstream pressure.

Optional Spike Guard™ Solenoid*

Reduces wire size requirements, allows twice as many valves to run simultaneously on a transformer, and lowers power costs with a lightning rating exceeding 20,000 volts.

Filter Screen on 2" and 3" Models

Allows for upstream filtration of water to ensure no clogging occurs inside the valve.

Flow Control Handle

Adjusts the flow of each zone on a system.

**Not compatible with 2-wire systems.*

Additional Features

- ✓ Tough glass-filled nylon and stainless steel construction
- ✓ No external tubing for either pressure-regulating model
- ✓ Self-aligning bonnet to ensure correct installation
- ✓ Self-cleaning, stainless steel metering rod
- ✓ Low-flow capability down to 5 gpm with EZReg
- ✓ Low-power requirement for longer wire runs
- ✓ EPDM diaphragm and seat seal



Effluent
Options
Available



Pressure
Regulation



DC Latching
Solenoid
Option

SPECIFICATIONS

Operational

- Flow Range:
 - 1": 5 to 50 gpm
 - 1½": 30 to 110 gpm
 - 2": 80 to 150 gpm
 - 3": 130 to 300 gpm
- Operating Pressure
 - 1" & 1½" Models: 10 to 220 psi
 - 2" & 3" Models: 20 to 220 psi
- Pressure Regulating:
 - Outlet (EZR-30): 5 to 30 psi ± 3
 - Outlet (EZR-100): 5 to 100 psi ± 3
 - Minimum flow requirement of 5 gpm
- Minimum Pressure Differential (between inlet and outlet) for Pressure Regulation: 10 psi
- Body Styles:
 - Globe/Angle – 1", 1½", 2" & 3" female threads
- 118-5982 Solenoid: 24 Vac (60 Hz) Standard
 - Inrush: 60 Hz, 0.4 amps
 - Holding: 60 Hz, 0.2 amps

Options Available

- EZReg®, 5–30 psi Regulator Module (EZR-30)
- EZReg, 5–100 psi Regulator Module (EZR-100)
- Effluent Water Solenoid Assembly, 24 Vac, 60 Hz; and Warning Tag (EFF-KIT-60HZ)
- Standard Solenoid, 24 Vac, 60 Hz (118-5982)
- Potted DC Latching Solenoid Assembly (DCLS-P)
- Spike Guard™ Solenoid, 24 Vac, 50/60 Hz (SGS-12)

Dimensions

- 1": 6¾" H x 35/8" W
- 1½": 7¼" H x 3⅝" W
- 2": 9½" H x 6⅛" W
- 3": 10¾" H x 6⅛" W

Warranty

- Five years

PRODUCT HIGHLIGHT



Pressure Regulator

The EZReg® module can regulate flows as low as 5 gpm with a 1" valve and only requires 10 psi differential to operate. The pressure regulator can be easily and quickly installed—even under pressure—with no danger of water geysers.

P-220 SERIES MODEL LIST

Model	Description	
WITH PRE-INSTALLED LATCHING SOLENOIDS		
P220-26-04	1" NPT, Globe/Angle	P220-26-94
P220-26-06	1½" NPT, Globe/Angle	P220-26-96
P220-26-08	2" NPT, Globe/Angle	P220-26-98
P220-26-010	3" NPT, Globe/Angle	P220-26-910
PRESSURE-REGULATED WITH EZ REG WITH PRE-INSTALLED LATCHING SOLENOIDS		
P220-27-04	1" NPT, Globe/Angle	P220-27-94
P220-27-06	1½" NPT, Globe/Angle	P220-27-96
P220-27-08	2" NPT, Globe/Angle	P220-27-98
P220-27-010	3" NPT, Globe/Angle	P220-27-910

P-220 SERIES PRESSURE LOSS DATA

Size	Config.	gpm Flow																						
		5	10	20	30	40	50	60	70	80	90	100	110	120	130	140	150	180	200	225	250	275	300	
1"	Globe	4.00	4.20	3.20	4.10	7.20																		
	Angle	4.00	4.20	3.10	2.70	4.80																		
1½"	Globe				1.60	2.30	3.60	5.20	7.00	9.20	11.20	13.60	16.40											
	Angle				1.30	1.60	2.80	4.00	5.50	7.10	8.90	10.90	13.50											
2"	Globe									2.10	2.70	3.30	4.00	4.80	5.60	6.50	7.50	8.70						
	Angle									1.20	1.60	2.00	2.40	2.80	3.30	3.90	4.40	5.20						
3"	Globe																2.50	3.00	4.10	5.30	6.70	8.30	10.10	
	Angle																1.90	2.40	3.30	4.30	5.50	6.90	8.50	

Note: For optimum performance when designing a system, be sure to calculate total Pressure Loss to ensure sufficient downstream pressure. For optimum regulation performance, size regulating valves toward the higher flow ranges. Flow rates are recommended not to exceed 5 psi loss.

Specifying Information—P-220 Series Valves

P220-2X-XX			
Model	Activation Type	Solenoid	Size
P220	2X	X	X
P220—P-220 Series Plastic Valve	26—NPT, Electric 27—NPT, Pressure-regulated EZR-100 (Standard)	0—Standard Solenoid 9—DC Latching Solenoid	4—1" 6—1½" 8—2" 10—3"

Example: A 1" P-220 Series plastic electric, pressure-regulating valve would be specified as: **P220-27-04**

TORO

P-220S SCRUBBER SERIES VALVES

FEATURES & BENEFITS

Multiple Design Configurations

Available in 1", 1 1/2", 2", and 3" inlet/outlet designs, all of which allow the flexibility of globe or angle orientation.

Durable Glass-Filled Nylon Construction

Robustly built to operate at pressures of up to 220 psi.

ACT (Active Cleansing Technology)

The industry's first active scrubber valve cleans continuously, whereas competing valves only clean upon their opening and closing.

Fabric-reinforced EPDM Diaphragm and EPDM Seat Seal

Designed to work in virtually all water applications.

Rugged Internal Plastic and Stainless Steel Components

The ACT scrubber turbine, nut and metering system are constructed of marine and aerospace-grade plastics and metals that make them resistant to chlorine- and ozone-treated water.

Available with Precise Pressure Regulation

Compact EZReg® dial-design technology ensures precise downstream pressure for optimized sprinkler head performance.

Completely Serviceable and Retrofittable

The ACT scrubber diaphragm assembly can be replaced, and can also be retrofit into previously installed P-220 models.

Additional Features

- ✓ Internal and external bleeds
- ✓ No external tubing for either pressure-regulating model
- ✓ Standard, built-in Schrader-type valve for downstream pressure verification
- ✓ Flow control independent of solenoid
- ✓ Self-aligning bonnet to ensure correct installation
- ✓ Self-cleaning stainless steel metering rod



Effluent
Options
Available



Pressure
Regulation



DC Latching
Solenoid
Option

SPECIFICATIONS

Operational

- Flow Range:
 - 1": 5 to 50 gpm
 - 1 1/2": 30 to 110 gpm
 - 2": 80 to 150 gpm
 - 3": 130 to 300 gpm
- Operating Pressure
 - 1" & 1 1/2" Models: 10 to 220 psi
 - 2" & 3" Models: 20 to 220 psi
- Pressure Regulating:
 - Outlet (EZR-30): 5 to 30 psi ± 3
 - Outlet (EZR-100): 5 to 100 psi ± 3
 - Minimum flow requirement of 5 gpm

- Minimum Pressure Differential (between inlet and outlet) for Pressure Regulation: 10 psi
- Body Styles:
 - Globe/Angle with female threads
- Solenoid: 24 Vac (60 Hz) Standard (118-5982)
 - Inrush: 60 Hz: 0.4 amps
 - Holding: 60 Hz: 0.2 amps

Options Available

- EZReg, 5–30 psi regulator module (EZR-30)
- EZReg, 5–100 psi regulator module (EZR-100)
- Effluent Water Solenoid Assembly, 24 Vac, 60 Hz; and Warning Tag (EFF-KIT-60HZ)
- Potted DC Latching Solenoid (DCLS-P)

Dimensions

- 1": 6 3/4" H x 3 5/8" W
- 1 1/2": 7 1/4" H x 3 5/8" W
- 2": 9 1/2" H x 6 1/8" W
- 3": 10 3/4" H x 6 1/8" W

Warranty

- Five years

PRODUCT HIGHLIGHT

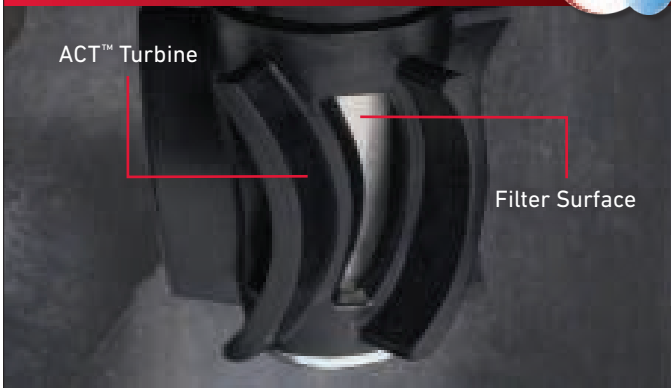

ACT™ Turbine

Filter Surface

The P-220S Scrubber Series Valves Feature Toro's Patented ACT™ (Active Cleansing Technology) system. The ACT system's durable turbine is in constant rotation, which in turn keeps the metering and filtration area free of dirt and algae build-up. The turbine is constructed of materials resistant to chlorine, chloramines, and ozone, thereby keeping the valve operating at peak performance.

P-220S SCRUBBER SERIES MODEL LIST

Model	Description
P220S-26-04	1" with ACT System
P220S-26-06	1 1/2" with ACT System
P220S-26-08	2" with ACT System
P220S-26-010	3" with ACT System
P220S-27-04	1" with EZReg and ACT™ System
P220S-27-06	1 1/2" with EZReg and ACT System
P220S-27-08	2" with EZReg and ACT System
P220S-27-010	3" with EZReg and ACT System
P220S-26-94	1" with ACT System & DC Latching Solenoid
P220S-26-96	1 1/2" with ACT System & DC Latching Solenoid
P220S-26-98	2" with ACT System & DC Latching Solenoid
P220S-26-910	3" with ACT System & DC Latching Solenoid
P220S-KIT-04	1" Scrubber diaphragm assembly kit
P220S-KIT-06	1 1/2" Scrubber diaphragm assembly kit
P220S-KIT-08	2" Scrubber diaphragm assembly kit
P220S-KIT-010	3" Scrubber diaphragm assembly kit

TORO P-220S SCRUBBER VALVES

Size	Config.	Flow																				
		5	10	20	30	40	50	60	70	80	90	100	110	120	130	140	150	180	200	250	300	
1"	Globe	4.63	4.74	3.10	6.05	10.75																
	Angle	4.14	4.64	2.54	5.53	9.46																
1 1/2"	Globe				1.56	2.85	4.36	6.28	8.57	11.20	14.03	17.20	20.46									
	Angle				1.51	2.28	3.69	5.29	6.97	9.26	11.80	14.60	17.40									
2"	Globe									3.57	4.62	5.33	6.80	8.20	9.02	10.46	11.61					
	Angle									2.79	3.50	4.41	5.62	6.39	7.35	8.81	9.37					
3"	Globe														2.06	2.34	2.70	3.88	4.86	7.26	10.23	
	Angle														1.86	2.16	2.44	3.35	4.11	6.42	9.31	

Note: For optimum performance when designing a system, be sure to calculate total Pressure Loss to ensure sufficient downstream pressure. For optimum regulation performance, size regulating valves toward the higher flow ranges.

Specifying Information—P-220S Scrubber Series Valves

P220S-2X-XX			
Model	Activation Type	Solenoid	Size
P220S	2X	X	X
P220S—P-220S Scrubber Series Plastic Valve	6—NPT, Electric 7—NPT, Pressure-regulated EZR-100 (Standard)	0—Standard 24 Vac Solenoid 9—DC Latching Solenoid	4—1" 6—1 1/2" 8—2" 10—3"

Example: A 2" P-220S Series plastic electric, pressure-regulating valve would be specified as: **P220S-27-08**

220 BRASS SERIES VALVES

FEATURES & BENEFITS

Leading Lightning Protection (Spike Guard™)

A lightning rating that exceeds 20,000 volts – nearly three times the protection of competing products.

Dirty Water Ready

A stainless steel 120-mesh filter enables dependable valve operation in dirty and reclaimed water applications.

Spike Guard Solenoid*

Reduces wire size requirements and allows twice as many valves to run simultaneously on a transformer, all while lowering power consumption and related costs.

EZReg® Pressure Regulator Compatible

Available in two fully-adjustable models, Toro EZReg Pressure Regulators allow the consistent regulation of pressure within a zone, ensuring optimal operation of all downstream sprinklers. EZReg Pressure Regulators thread directly to the valve bonnet – no special adaptor required and no need to remove the solenoid. The desired pressure can be set fast and with a high level of accuracy thanks to an easy-to-read turn dial design.

**Not compatible with 2-wire systems.*

Additional Features

- ✓ Commercial-grade 316 Stainless Steel stem for maximum corrosion resistance
- ✓ Manual Flow Control; adjustable to full shut-off
- ✓ Robust, double-beaded, fabric-reinforced rubber diaphragm
- ✓ Built-in Schrader-type valve is standard on all models for fast downstream pressure verification
- ✓ EZReg Pressure Regulator can be installed as a service kit without having to drain the main line



Effluent
Options
Available



Spike Guard™
Standard*



Pressure
Regulation



DC Latching
Solenoid
Option

SPECIFICATIONS

Operational

- Flow Range:
 - 1" model: 5 to 40 gpm
 - 1 1/4" model: 20 to 100 gpm
 - 1 1/2" model: 20 to 120 gpm
 - 2" model: 30 to 170 gpm
 - 2 1/2" model: 60 to 250 gpm
 - 3" model: 80 to 350 gpm
- Operating Pressure: 10 to 220 psi
- Pressure Regulating:
 - Outlet (EZR-30): 5 to 30 psi ± 3
 - Outlet (EZR-100): 5 to 100 psi ± 3
 - Minimum flow requirement of 5 gpm

- Minimum Pressure Differential (between inlet and outlet) for Pressure Regulation:
 - 1", 1 1/4", and 1 1/2" models: 10 psi
 - 2", 2 1/2", and 3" models: 20 psi
- Burst Pressure Safety Rating: 750 psi
- Body Styles:
 - Globe orientation – 1", 1 1/4", 1 1/2", and 2" models, female threads
 - Angle orientation – 2 1/2" and 3" models, female threads

Options Available

- EZReg®, 5-30 psi adjustable Pressure Regulator (EZR-30)
- EZReg®, 5-100 psi adjustable Pressure Regulator (EZR-100)
- Effluent Water Solenoid and warning tag; lavender color, 24V AC / 60 Hz (EFF-KIT-60HZ)
- 24 Vac Solenoid; 60 Hz, 18-inch leads, and captive plunger (118-5982)
- Potted DC Latching Solenoid (DCLS-P)

Dimensions

- 1" model: 5 1/4" H x 5" W
- 1 1/4" model: 6 1/2" H x 6" W
- 1 1/2" model: 6 1/2" H x 6" W
- 2" model: 7 1/2" H x 7" W
- 2 1/2" model: 8 3/4" H x 8 1/2" W
- 3" model: 8 3/4" H x 8 1/2" W

Warranty

- Five years



PRODUCT HIGHLIGHT

Dirty Water Resistance

The 120 mesh stainless steel filter screen is positioned on the supply side of the water stream. It is constantly flushed by the flow, enabling the use of very dirty water without clogging. Stainless steel construction of both the filter screen and the valve solenoid seat ensures long component life in all types of water and pressures.

220 BRASS SERIES VALVES MODEL LIST

Model	Description	Model	Description
220-26-04	1" Inlet/Outlet; Globe	WITH DC LATCHING SOLENOID	
220-26-05	1 1/4" Inlet/Outlet; Globe	220-26-94	1" Inlet/Outlet; Globe
220-26-06	1 1/2" Inlet/Outlet; Globe	220-26-95	1 1/4" Inlet/Outlet; Globe
220-26-08	2" Inlet/Outlet; Globe	220-26-96	1 1/2" Inlet/Outlet; Globe
220-26-09	2 1/2" Inlet/Outlet; Angle	220-26-98	2" Inlet/Outlet; Globe
220-26-00	3" Inlet/Outlet; Angle	220-26-99	2 1/2" Inlet/Outlet; Angle
PRESSURE REGULATED WITH EZREG®		220-26-90	3" Inlet/Outlet; Angle
220-27-04	1" Inlet/Outlet; Globe	ELECTRIC VALVES LESS SOLENOID	
220-27-05	1 1/4" Inlet/Outlet; Globe	220-26-64	1" Inlet/Outlet; Globe
220-27-06	1 1/2" Inlet/Outlet; Globe	220-26-66	1 1/2" Inlet/Outlet; Globe
220-27-08	2" Inlet/Outlet; Globe	220-26-68	2" Inlet/Outlet; Globe
220-27-09	2 1/2" Inlet/Outlet; Angle	220-26-60	3" Inlet/Outlet; Angle
220-27-00	3" Inlet/Outlet; Angle		
WITH 24 VAC SOLENOID			
220-26-74	1" Inlet/Outlet; Globe		
220-26-75	1 1/4" Inlet/Outlet; Globe		
220-26-76	1 1/2" Inlet/Outlet; Globe		
220-26-78	2" Inlet/Outlet; Globe		

220 BRASS SERIES VALVES PRESSURE LOSS DATA

Model	Type	Gallons Per Minute																		
		5	10	15	20	30	40	50	60	70	80	100	120	150	170	180	200	250	300	350
1"	Electric	1.8	2.0	2.2	3.1	5.1	7.8													
1 1/4"	Electric				1.9	2.5	2.7	3.5	4.1	5.6										
1 1/2"	Electric				2.2	2.5	2.8	3.1	3.8	5.0	6.6									
2"	Electric					3.1	3.2	2.9	3.0	3.3	3.4	4.5	6.6	10.1	13.5	14.9				
2 1/2"	Electric								2.0	2.2	2.3	2.4	2.5	3.0	4.0	4.5	5.5			
3"	Electric										2.2	2.4	2.5	3.0	4.0	4.5	5.5	6.5	7.0	7.5

Notes: For optimal performance when designing a system, it is recommended that total Pressure Loss be calculated to ensure sufficient downstream pressure. For optimum pressure regulation performance, size regulating valves towards the higher flow ranges. Flow rates are recommended not to exceed 5 psi loss.

Specifying Information – 220 Brass Series Valves

220-2X-X-X			
Model	Type	Solenoid	Thread Size
220	2X	X	X
220-220 Series Brass Valve	6 - NPT, Electric 7 - NPT, Pressure-regulated (5-100 psi)	0 - Spike Guard Solenoid 6 - Less Solenoid 7 - 24 Vac Solenoid 9 - DC Latching Solenoid	4–1" 5–1 1/4" 6–1 1/2" 8–2" 9–2 1/2" 0–3"

Example: A 1" NPT, pressure-regulated 220 Series Brass Valve with Spike Guard Solenoid, would be specified as: **220-27-04**

Note: 1", 1 1/2" and 2"—globe configuration. 2 1/2" and 3"—angle configuration.



QUICK COUPLER SERIES

FEATURES & BENEFITS

Stainless Steel and Brass Construction

Quick Couplers are also available with metal or vinyl covers in locking or non-locking options.

Multiple Models to Choose From

There are a variety of one-piece and two-piece models in 3/4" and 1" sizes, including ACME thread key connections.

Eliminate Tangled Hoses

The 360-degree hose swivel provides movement without hose tangling.



QUICK COUPLER SERIES PRESSURE LOSS DATA

Model	gpm Flow													
	10	15	20	25	30	35	40	50	60	70	85	100		
3/4" inlet	1.5	3.1	5.3	8.5										
1" inlet			1.1	2.2	3.6	5.7	8.0							

Note: For optimum sprinkler performance when designing a system, be sure to calculate total Pressure Loss to ensure sufficient downstream pressure. Values listed in psi.

QUICK COUPLER VALVES MODEL LIST

Model	Description	Key(s)
075-SLSC	3/4" inlet QCV, one-piece body, Single Lug with Stainless Steel cover	075-SLK
100-SLSC	1" inlet QCV, one-piece body, Single Lug with Stainless Steel cover	100-SLK
100-SLVC	1" inlet QCV, one-piece body, Single Lug with Yellow Vinyl cover	100-SLK
100-SLVLC	1" inlet QCV, one-piece body, Single Lug with Yellow Vinyl locking cover	100-SLK
100-2SLVC	1" inlet QCV, two-piece body, Single Lug with Yellow Vinyl cover	100-SLK
100-ATLVC	1" inlet QCV, one-piece body, ACME thread with Effluent Vinyl locking cover	100-AK
100-2SLLVC	1" inlet QCV, two-piece body, Single Lug with Effluent Vinyl locking cover	100-SLK

QUICK COUPLER KEYS AND ACCESSORIES MODEL LIST

Model	Description
075-SLK	3/4" Single Lug Key with 3/4" Male and 1/2" Female NPT Outlet
100-AK	1" ACME Thread Key with 1" Pipe Thread Outlet
100-SLK	1" Single Lug Key with 1" Male Pipe Thread and 3/4" Female NPT Outlet
075-75-MHS	3/4" NPT x 3/4" MHT Hose Swivel
075-MHS	1" NPT x 3/4" MHT Hose Swivel
100-MHS	1" NPT Inlet x 1" MHT, Hose Swivel
LK	Key for Locking Cap

Specifying Information—Quick Couplers

XXX-XXX-XXX		
Size	Configuration	Cover
XXX	XXX	XXX
075—3/4" 100—1"	SL—One-piece, Single Lug 2SL—Two-piece, Single Lug AT—ACME Thread	SC—Standard Cover VC—Vinyl Cover LVC—Effluent Vinyl Cover VLC—Vinyl Locking Cover

Example: A 1" one-piece, single lug Quick Coupler with a vinyl locking cover, would be specified as: **100-SLVLC**

OMNIREG® MODULAR PRESSURE REGULATOR

FEATURES & BENEFITS

One Model Fits All Heavy-duty Commercial 100 Series (Century Plus), 700 Series (Ultraflow®), 200B and 311A Series Valves*

Compatible with Irritrol commercial valves

Maintains Downstream Pressure

For consistent and efficient operation

Requires Only 1 GPM to Operate

Ideal for low-flow applications

"Drop In" Installation is Fast and Easy, Requiring Tightening of Only Two Capture Screws

For reduced labor time

Built-in Schroeder Valve

For independent pressure readings



* Compatible with Century PLUS (excluding anti-contamination models), 700 UltraFlow® (1", 1½" and 2") and 311A manufactured after 1/1/96; 700 UltraFlow (¾") manufactured after 5/4/96; and 200B manufactured after 12/1/98.

Specifying Information – OMNIREG® Modular Pressure Regulator

OMR-XXX	
Model	Size
OMR	X
Modular regulator	30 - 5-30 psi 100 - 5-100 psi DS - Downstream sensing kit**
Example: A regulator to regulate from 5-30 psi = OMR-30	

SPECIFICATIONS

Operational

- Flow range: 1 to 300 GPM
- Inlet pressure range: Up to 200 psi
- Pressure regulation: OMR-30: 5 to 30 psi, OMR-100: 5 to 100 psi
- Inlet pressure to be 10 psi greater than outlet pressure

TOOLS & GAUGES



2400-45

Threaded nut-ring wrench speeds assembly and service of 2400, 2600, 2711DPR & 2713DPR valves



SPK-100

100 psi weatherproof gauge (fits OmniReg® & all Hardie & Richdel® pressure regulators)

OMNIREG SERIES MODEL LIST

Model	Description
OMR-30	Modular regulator 5-30 psi
OMR-100	Modular regulator 5-100 psi
OMR-DS	Downstream sensing

VALVE ACCESSORIES

SOLENOIDS



DCLS-P

- Potted DC Latching Solenoid for Toro valves
- Compatible with P-200, P-220S Scrubber and 220 Brass Series valves



118-5982

- 24 Vac Solenoid assembly for P-220, P-220S Scrubber, and 220 Brass Series valves.
- Captive hex plunger
- 18" leads



SGS-12

- 24 Vac Spike Guard Solenoid assembly for P-220, P-220S Scrubber, and 220 Brass Series valves
- 20,000 volts lightning rating
- Inrush 0.2 amps/ Holding 0.1 amps

Note: Not compatible with 2-wire systems.

EFFLUENT WATER INDICATORS



EFF-KIT-60HZ

- Lavender-colored 118-5982 Solenoid assembly for P-220, P-220S Scrubber, and 220 Brass Series valves
- Lavender-colored Effluent warning tag



RWSG-Kit

- Effluent tag and solenoid sticker

EZREG® PRESSURE/INSTALLATION REGULATOR & EHC ACCESSORIES



EZR-30 and EZR-100

- Pressure regulator module for use with P-220, P-220S Scrubber and 220 Brass Series Valves
- EZR-30: 5–30 psi
- EZR-100: 5–100 psi



995-51

- Pressure gauge kit



995-49

- 0-200 psi pressure gauge
- Hermetically sealed shock resistant face



995-14

- Supply screen fitting



995-02

- Flushing adaptor

VALVE SERVICE KITS

REPAIR KITS



SPK-HR1

- Pre-packaged repair kit includes diaphragm assembly, O-ring, metering rod and fasteners (bulk 24 per)



R205KIT

- Pre-packaged repair kit for 205 Series non-flow control valves. Includes diaphragm assembly, bonnet assembly, fasteners and spring



R205TFKIT

- Pre-packaged repair kit for 205TF flow control valves. Includes diaphragm assembly, bonnet assembly, fasteners and spring



R936XX1

- Pre-packaged repair kit for century series. Includes complete bonnet assembly and diaphragm for retrofitting old century Series valves from Richdale®, Hardie and Hydro-Rain®



SPK-700-X

- Pre-packaged repair kit for UltraFlow® Series valves includes diaphragm assembly, support ring, seat seal, O-rings & fasteners (bulk 24 per; repair instructions & parts breakdown included)



SPK-100-X

- Pre-packaged repair kit for Century Series valves includes diaphragm assembly, O-ring, metering rod and fasteners (bulk 24 per; repair instructions and parts breakdown included)



R1000PX (Richdel®)

- Pre-packaged repair kit for Century Series valves includes diaphragm assembly, O-rings, metering rod and fastening nuts (bulk 24 per; repair instructions and parts breakdown included)



100P-S-KIT

- 100 Century Series Scrubber valve diaphragm assembly kit. Complete with scrubbing turbine, EPDM diaphragm, EPDM seat seal & 316SS filter. Available fully assembled & ready to drop in a Century Series valve

SPK-700X-XX

Model	Size
SPK-700B	0.75"
SPK-700	1"
SPK-700	1.5"
SPK-700	2"

SPK-100-XX

Model	Size
SPK-100	1"
SPK-100	1.5"
SPK-100	2"
SPK-100	3"

R100P-XX

Model	Size
R100P	1"
R100P	1.5"
R100P	2"
R100P	3"

100P-X-S-KIT

Model	Size
100P	1"
100P	1.5"
100P	2"
100P	3"

Irritrol

SR-1 PUMP START RELAY

FEATURES & BENEFITS

Can Also Be Used with the Irritrol PC Control System for Switching Control of Low Voltage Landscape Lighting

Saves the expense of an extra timer and puts irrigation and landscape lighting control in one location on the owner's computer.

Electrical Relays for Both Low Voltage (24V ac) Control Switching and High Voltage (120V ac or 240V ac) Main Power Contacts

- ✓ Allows remote pump switching using 24V ac output from an irrigation controller's master valve/pump start circuit
- ✓ Opens and closes main power contacts for pumps (1HP at 120V ac 1 Phase or 2HP at 250V ac 1 Phase)
- ✓ Note: 2HP at 120V ac will exceed maximum amp rating

Highly Efficient 0.1 Amp Operating Requirement

Draws less holding power than most solenoid valves.



SPECIFICATIONS

Coil

- 24V ac, 3VA (19V ac Min, 30V ac Max)

Coil Draw

- 0.1 Amp

Contacts

- Up to 1 HP at 120V ac, 1 Phase Up to 2 HP at 250V ac, 1 Phase (20A at 250V ac)



0 PAB A11AZH 06

Amer

Code

M D178

480PSI

FVC 1120 0211 CM

4002028552

05 N 1

754826200495

SPRAYS & NOZZLES



TORO[®]

Irritrol[®]



SPRAYS & NOZZLES

Pages 70-99

SPRAYS

570Z Series Spray Bodies	72-73
570Z PR Series Spray Bodies	74
570Z XF Series Spray Bodies	75
I-PRO™ Series Sprays	76-77
I-PRO PR Series Sprays	78-79
LPS Series Sprays	80-81

NOZZLES

Precision™ Series Spray Nozzles	82-83
MPR & MPR Plus Spray Nozzles	84-85
TVAN Variable Arc Nozzles	86-87
I-PRO™ Nozzles	88-89
PRO-Van Nozzles	90-91
Pressure-Compensating Flood Bubblers	92
500 Series Bubblers	92
Stream Spray Nozzles	93
Stream Bubbler Nozzles	93
533 Bubbler Nozzles	94

FLEX PIPE

Super Funny Pipe®	95
Super Funny Pipe Swing Joints	95
Super Blue Flex® Series	96
Super Blue Flex Assemblies	97
Super Blue Flex Fittings	97

SPRAYS ACCESSORIES

Precision™ Check Valve	98
Spray Tools & Accessories	99



570Z SERIES SPRAY BODIES



FEATURES & BENEFITS

Zero Flush Wiper Seal

The elimination of flushing on pop-up allows for more sprinklers to be installed per zone.

UV-resistant, Professional-grade ABS Construction

UV-resistant, professional-grade ABS construction for dependable performance whether in residential or commercial settings. Capable of withstanding operating pressures of up to 75 psi.

Several Body Sizes

Several body sizes—to satisfy varying installation requirements

Optional One-Piece Check Valve (570CV)

Pre-installed from the factory or easily installed in the field, Toro's one-piece check valve prevents low-head drainage on elevation changes of up to 10 feet.

Ratcheting Riser

Quick and precise arc adjustment on all pop-up models.



Effluent Options Available



Check Valve Options Available

Specifying Information—570Z Series

570X-XXXXX-XXXXXXX					
Base Model	Pop-Up Height	Spring and Inlet	Optional	Optional	Optional
570X	XX	XXX-	XXX	XXX	X
S — Shrub Z — Lawn Pop-up	2 — 2" 3 — 3" 4 — 4" 6 — 6" 12 — 12"	P — Standard LP — Low Pressure SI — Std. Side Inlet* LPSI — Low Pressure SI	XF — X-Flow® Technology PR — Pressure Regulator PRX — Pressure Regulator with XF	COM — Check Valve**	E — Effluent

Example: A 570Z PRX Series Sprinkler with a 6" pop-up height, side inlet would be specified as: **570Z-6SI-PRX**

*Available for 6" and 12" models. **Not compatible with Side Inlet or Shrub models.

SPECIFICATIONS

Operational

- Radius: 2 feet to 26 feet
- Operating pressure range: 20-75 psi (15-75 psi for Low Pressure models)
- Recommended operating pressure for spray nozzles: 30 psi
- Recommended operating pressure for rotating nozzles: 45 psi
- Flow rate: 0.5 – 4.5 gpm

Dimensions

- Body diameters:
 - 1 3/8" on 2", 3", 4", 6" and 6" Side Inlet
 - 1 5/8" on 12"
 - 1 3/4" on 12" Side Inlet
- Cap diameter: 2"
- Inlet thread: 1/2" Female
- Side inlet location: 4 3/4" (measured from the top of spray head to center of the side inlet port)

Warranty

- Five years on all models



570Z & 570ZLP

570S
Shrub Adapter

570Z-2P 2" Spray Head
570Z-2LP 2" Spray Head,
Low Pressure

570Z-3P 3" Spray Head
570Z-3LP 3" Spray Head,
Low Pressure

570Z-4P 4" Spray Head
570Z-4LP 4" Spray Head,
Low Pressure

570Z-6P 6" Spray Head
570Z-6LP 6" Spray Head,
Low Pressure

570Z-6SI 6" Spray Head,
Side Inlet body
570Z-6LPSI 6" Spray Head,
Low Pressure, Side Inlet body

570Z-12P 12" Spray Head
570Z-12LP 12" Spray Head,
Low Pressure

570Z-12SI 12" Spray Head,
Side Inlet body
570Z-12LPSI 12" Spray Head,
Low Pressure, Side Inlet body

570Z-4P-COM 4" Spray Head
with Check Valve

570Z-6P-COM 6" Spray Head
with Check Valve

570Z-12P-COM 12" Spray Head
with Check Valve



570ZXF

570S-XF
Shrub Riser
with X-Flow

570Z-4P-XF
4" XF Spray Head

570Z-6P-XF
6" XF Spray Head

570Z-6SI-XF
6" XF Spray Head,
Side Inlet Body

570Z-12P-XF
12" XF Spray Head

570Z-12SI-XF
12" XF Spray Head,
Side Inlet Body

570Z-4P-XFCOM
4" XF Spray Head
with Check Valve

570Z-6P-XFCOM
6" XF Spray Head
with Check Valve

570Z-12P-XFCOM
12" XF Spray Head
with Check Valve



570ZPR

570S-PR
PR Shrub Riser

570Z-4P-PR
4" PR Spray Head

570Z-6P-PR
6" PR Spray Head

570Z-12P-PR
12" PR Spray Head

570Z-4P-PRCOM
4" PR Spray Head
with Check Valve

570Z-6P-PRCOM
6" PR Spray Head
with Check Valve

570Z-12P-PRCOM
12" PR Spray Head
with Check Valve



570ZPRX

570S-PRX
PRX Shrub Riser

570Z-4P-PRX
4" PRX Spray Head

570Z-6P-PRX
6" PRX Spray Head

570Z-6SI-PRX
6" PRX Spray Head,
Side Inlet Body

570Z-12P-PRX
12" PRX Spray Head

570Z-12SI-PRX
12" PRX Spray Head,
Side Inlet Body

570Z-4P-PRXCOM
4" PRX Spray Head
with Check Valve

570Z-6P-PRXCOM
6" PRX Spray Head
with Check Valve

570Z-12P-PRXCOM
12" PRX Spray Head
with Check Valve



570Z PR SERIES SPRAY BODIES



FEATURES & BENEFITS

Patented In-riser Pressure Regulator

Integrated in-riser 30 psi pressure regulator maintains consistent nozzle performance at 30 psi and eliminates misting and overspray that results from high pressure or inconsistent pressure at the point of connection.



570ZPR

- 570S-PR PR Shrub Riser
- 570Z-4P-PR 4" PR Spray Head
- 570Z-6P-PR 6" PR Spray Head
- 570Z-12P-PR 12" PR Spray Head
- 570Z-4P-PRCOM 4" PR Spray Head with Check Valve
- 570Z-6P-PRCOM 6" PR Spray Head with Check Valve
- 570Z-12P-PRCOM 12" PR Spray Head with Check Valve



Effluent Options Available



Check Valve Options Available

570Z PR SERIES SPRAY BODIES



Patented In-Riser Pressure Regulator
Maintains constant 30 psi (2,1 Bar) psi outlet pressure, which minimizes misting and fogging caused by pressures above 30 psi (2,1 Bar).



Zero Flush Wiper Seal
Prevents flushing on pop-up, allowing more sprinklers on the same line.



Enhanced Retraction Spring & Wiper Seal
Robust retraction spring and enhanced seal material ensures positive pop-up and retraction on all 570Z models.



Small 2" Diameter Cap
Less visible, reducing damage from exposure or vandals.

SPECIFICATIONS

Operational

- Radius: 2 feet to 26 feet
- Operating pressure range: 20-75 psi (15-75 psi for Low Pressure models)
- Recommended operating pressure for spray nozzles: 30 psi
- Flow rate: 0.5 – 4.5 gpm

Dimensions

- Body diameters:
 - 1³/₈" on 2", 3", 4", 6" and 6" Side Inlet
 - 1⁵/₈" on 12"
 - 1³/₄" on 12" Side Inlet
- Cap diameter: 2"
- Inlet thread: 1/2" Female
- Side inlet location: 4³/₄" (measured from the top of spray head to center of the side inlet port)

Warranty

- Five years on all models



570Z XF SERIES SPRAY BODIES



FEATURES & BENEFITS

Zero Flush Wiper Seal

Zero-flush wiper seal is pressure activated and prevents flushing on pop up, which ensures all sprinklers within the zone achieve their full pop-up height.

X-Flow® Technology

The X-Flow in-stem flow shut-off device is built into the riser and restricts water loss by 99% should the nozzle be removed or damaged.

The exclusive X-Flow device greatly:





- reduces water waste
- landscape erosion
- wet hardscape safety concerns

Furthermore, X-Flow allows for 'dry' nozzle and filter replacement or system maintenance while the system is running.



570ZXF

- 570S-XF** Shrub Riser with X-Flow
- 570Z-4P-XF** 4" XF Spray Head
- 570Z-6P-XF** 6" XF Spray Head
- 570Z-6SI-XF** 6" XF Spray Head, Side Inlet Body
- 570Z-12P-XF** 12" XF Spray Head
- 570Z-12SI-XF** 12" XF Spray Head, Side Inlet Body
- 570Z-4P-XFCOM** 4" XF Spray Head with Check Valve
- 570Z-6P-XFCOM** 6" XF Spray Head with Check Valve
- 570Z-12P-XFCOM** 12" XF Spray Head with Check Valve

570Z XF SERIES SPRAY BODIES	
 <p>X-Flow® Water Shut-Off Device Built into the riser and restricts water loss by 99% if the nozzle is removed or damaged, eliminating potential erosion or safety concerns.</p>	 <p>Zero Flush Wiper Seal Prevents flushing on pop-up, allowing more sprinklers on the same line.</p>
 <p>Small 2" Diameter Cap Less visible, reducing damage from exposure or vandals.</p>	 <p>One-Piece Check Valve Easily installed at the factory or in the field. Maintains up to 10' elevation change.</p>
 <p>Enhanced Retraction Spring & Wiper Seal Robust retraction spring and enhanced seal material ensures positive pop-up and retraction on all 570Z models.</p>	



Without X-Flow

With X-Flow



I-PRO™ SERIES SPRAYS

FEATURES & BENEFITS

Pressure-activated Seal with Lubricant Additive

Cleans debris from stem, reduces flow-by during pop-up and prevents leaking between cap and body. Extra lubricant additive further eliminates stick-ups

Pre-installed In-riser Pressure Regulator (optional)

Maintains optimum nozzle performance at 30 psi and eliminates misting in varying pressure applications

Pre-installed Check Valve (optional)

Prevents low-head drainage, eliminating flood or erosion damage by keeping water in lateral pipes in elevation changes up to 14'

Sturdy and Robust, Textured Body

Provides for easy installation with a non-slip grip

Side and Bottom Inlets on 6" and 12" Models (6" also available in non-side inlet)

Reduces installation time

Heavy-duty, Stainless Steel Retraction Spring

Ensures positive pop-down

Male-threaded Riser

Compatible with any female-threaded nozzle in the industry

Pre-installed Flush Plug

Makes system flushing a breeze and allows for easy nozzle installation

Ratcheting Riser

Easiest ratchet in the market, even while hands are wet, yet won't come out of adjustment!



I-PRO300 I-PRO400 I-PRO600 I-PRO600SI I-PRO1200SI

Specifying Information — I-Pro™ Series

I-PRO-XX-XXX-X			
Model	Height	Side Inlet	Optional
XXXX	XX	XXX	X
I-PRO-PR - I-PRO pop-up spray head series with pressure regulator	400 - 4" 600 - 6" 1200 - 12"	SI - Side inlet	PR - Pre-installed pressure regulator PR-CV - Pre-installed pressure regulator and check valve
Example: An I-PRO-PR Series sprinkler with a 12" pop-up height, side inlet, pressure regulation option and check valve = I-PRO-PR1200-SI-PR-CV			

PRODUCT HIGHLIGHT

Superior Performing Wiper Seal

Additional lubricant additive helps eliminate stick-ups

Tapered lip design prevents the intrusion of debris

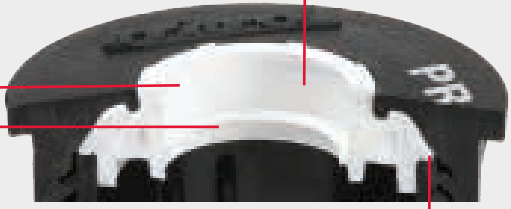

Pressure-activated lip seal ensures a positive seal around the riser and reduces "flow-by"

Lip creates positive seal to prevent body to cap leaks

SPECIFICATIONS

Operational

- Inlet size: 1/2" female NPT threads
- Exposed diameter: 2 1/4"
- Body diameter: 1 5/8"
- Body height:
 - I-PRO300: 4 7/8"
 - I-PRO400: 5 3/4"
 - I-PRO600: 9 1/4"
 - I-PRO1200: 16"
- Side inlet: 4 3/8" from center of side inlet to top of cap
- Recommended operating pressure:
 - Standard: 20-50 psi (max 75 psi)
 - CV: 25-50 psi (max 75 psi)
 - PR: 30-70 psi (max 75 psi)
- Precipitation rate data: 1.62 - 3.08 in/hr
 - Spacing: 4' - 15'
 - Flow-by: 0 at 10 psi or greater; .1 GPM otherwise

Warranty

- Five years

I-PRO™ SERIES SPRAY ACCESSORIES



I-PRO-NPC (Recycled-Water Cap)

- Threads onto all I-PRO Series spray head bodies and Rain Bird®* 1800®* Series bodies
- UV-resistant
- Heavy-duty ABS material



I-PRO-CV (I-Pro Check Valve)

- For use in I-Pro series spray head
- Ideal solution for protection against low-head drainage
- Reduce water waste and erosion



HS100 (Shrub Adapter)

- Threads directly onto riser
- UV-treated
- Heavy-duty ABS
- Accepts all Irritrol® and any other female-threaded nozzle

*Rain Bird and 1800 are registered trademarks of Rain Bird Corporation in the U.S. and other countries.

I-PRO SERIES SPRAY HEADS

Model	Description
I-PRO300	3" Pop-Up
I-PRO400	4" Pop-Up
I-PRO400-CV	4" Pop-Up w/Check Valve
I-PRO400-PR	4" Pop-Up w/Pressure Regulator
I-PRO400-PR-CV	4" Pop-Up w/Pressure Regulator and Check Valve
I-PRO600	6" Pop-Up
I-PRO600-CV	6" Pop-Up w/Check Valve
I-PRO600-PR	6" Pop-Up w/Pressure Regulator
I-PRO600-PR-CV	6" Pop-Up w/Pressure Regulator and Check Valve
I-PRO600-SI	6" Pop-Up w/Side Inlet
I-PRO600-SI-PR	6" Pop-Up w/Side Inlet and Pressure Regulator
I-PRO1200-SI	12" Pop-Up w/Side Inlet
I-PRO1200-SI-CV	12" Pop-Up w/Side Inlet and Check Valve
I-PRO1200-SI-PR	12" Pop-Up w/Side Inlet and Pressure Regulator
I-PRO1200-SI-PR-CV	12" Pop-Up w/Side Inlet, Pressure Regulator and Check Valve



I-PRO™ PR SERIES SPRAYS

FEATURES & BENEFITS

In-riser Pressure Regulator

Maintains consistent nozzle performance at 30 or 40 psi and eliminates misting and overspray that results from high pressure or inconsistent pressure at the point of connection.

Pre-installed Check Valve - Optional

Prevents low-head drainage, eliminating flood or erosion damage by keeping water in lateral pipes in elevation changes up to 14'.

Heavy-duty Textured Body

UV-resistant, professional-grade ABS construction for dependable performance whether in residential or commercial settings.

Easy-to-adjust Ratcheting Riser

Requires far less effort than competing spray bodies, the ratchet easily adjusts when under pressure or with wet hands, and maintains its position cycle after cycle.

Male-threaded Riser

Compatible with any female-threaded nozzle in the industry.



I-PRO400-PR

I-PRO600-SI-PR

I-PRO600-PR

I-PRO1200-SI-PR

PRODUCT HIGHLIGHT

Superior Performing Wiper Seal

Additional lubricant additive helps eliminate stick-ups

Tapered lip design prevents the intrusion of debris



Pressure-activated lip seal ensures a positive seal around the riser and reduces "flow-by"

Lip creates positive seal to prevent body to cap leaks

SPECIFICATIONS

Operational

- Inlet size: 1/2" female NPT threads
- Exposed diameter: 2 1/4"
- Body diameter: 1 5/8"
- Body height:
 - I-PRO400: 5 3/4"
 - I-PRO600: 9 1/4"
 - I-PRO1200: 16"
- Side inlet: 4 3/8" from center of side inlet to top of cap
- Recommended operating pressure:
 - 40-75 psi for 30 psi models
 - 50-75 psi for 40 psi models
 - Maximum operating pressure of 75 psi

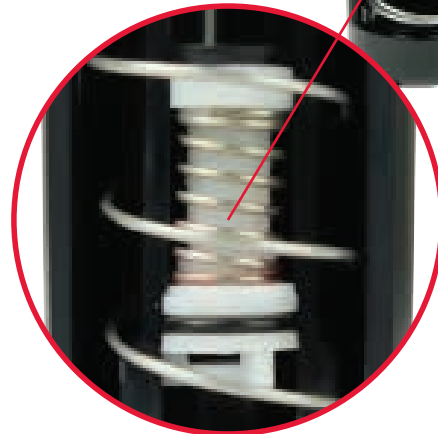

Pressure Regulator

I-PRO™ PR SERIES SPRAY HEADS

Model	Description
I-PRO400-PR	4" Pop-Up w/ 30 PSI Pressure Regulator
I-PRO400-PR-CV	4" Pop-Up w/ 30 PSI Pressure Regulator/Check Valve
I-PRO400-PR40	4" Pop-Up w/ 40 PSI Pressure Regulator
I-PRO400-PR40-CV	4" Pop-Up w/ 40 PSI Pressure Regulator/Check Valve
I-PRO600-PR	6" Pop-Up w/ 30 PSI Pressure Regulator
I-PRO600-PR-CV	6" Pop-Up w/ 30 PSI Pressure Regulator/Check Valve
I-PRO600-SI-PR	6" Pop-Up w/ Side Inlet and 30 PSI Pressure Regulator
I-PRO600-PR40	6" Pop-Up w/ 40 PSI Pressure Regulator
I-PRO600-PR40-CV	6" Pop-Up w/ 40 PSI Pressure Regulator/Check Valve
I-PRO600-SI-PR40	6" Pop-Up w/ Side Inlet and 40 PSI Pressure Regulator
I-PRO600-SI-PR40-CV	6" Pop-Up w/ Side Inlet, 40 PSI Pressure Regulator/Check Valve
I-PRO1200-SI-PR	12" Pop-Up w/ Side Inlet and 30 PSI Pressure Regulator
I-PRO1200-SI-PR-CV	12" Pop-Up w/ Side Inlet, 30 PSI Pressure Regulator/Check Valve
I-PRO1200-SI-PR40	12" Pop-Up w/ Side Inlet and 40 PSI Pressure Regulator
I-PRO1200-SI-PR40-CV	12" Pop-Up w/ Side Inlet, 40 PSI Pressure Regulator/Check

Specifying Information — I-Pro™ PR Series

I-PRO-XX-XXX-X			
Model	Height	Side Inlet	Optional
XXXX	XX	XXX	X
I-PRO-PR pop-up spray head series with pressure regulator	400 - 4" 600 - 6" 1200 - 12"	SI - Side inlet	PR - Pre-installed pressure regulator PR-CV - Pre-installed pressure regulator and check valve
Example: An I-PRO-PR Series sprinkler with a 12" pop-up height, side inlet, pressure regulation option and check valve = I-PRO-PR1200-SI-PR-CV			

LPS SERIES SPRAYS



FEATURES & BENEFITS

Pressure Activated Seal

Minimizes flow-by during pop-up and keeps debris away from stem during retraction.

Stainless Steel Retraction Spring

This heavy-duty spring ensures positive pop-down.

Easy Grip Top

Unique grip-and-turn adjustment from the top of the nozzle – wet or dry.

Removable Components

Nozzle, screen and internal components are easily removed for flushing and servicing.

Compatible With All 570Z Nozzles

Available with pre-installed Toro Variable Arc Nozzles (TVAN) in five radii or can accept any 570Z nozzle offering.

Eliminate Low Head Drainage

The LPS sprinkler series has an optional check valve rated to hold back 7' (2,1m) of elevation change. This helps to eliminate low head drainage and keeps the lines charged to lessen water hammer potential.

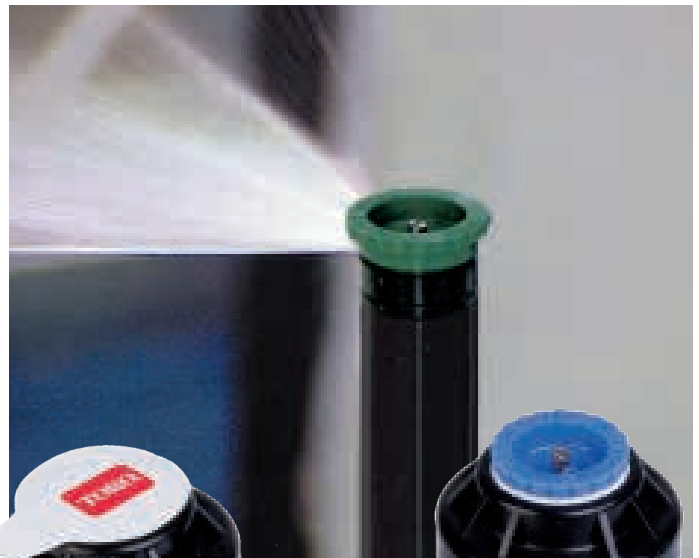

PRODUCT HIGHLIGHT

Water Management

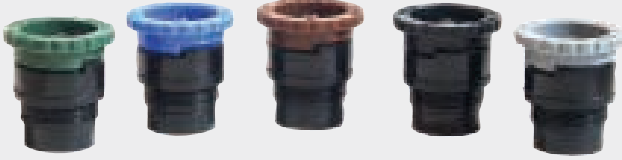

Easy Arc Adjustment Means Accurate Watering

TVAN Series nozzles are designed to deliver effective watering coverage with maximum irrigation efficiency. Whether a standard size, odd angle or irregularly shaped area, the TVAN Series is able to meet the watering requirements with just one nozzle. There is no need to worry about dry spots on lawns or wasting water on sidewalks, driveways and other hardscapes.

Optional Check valve

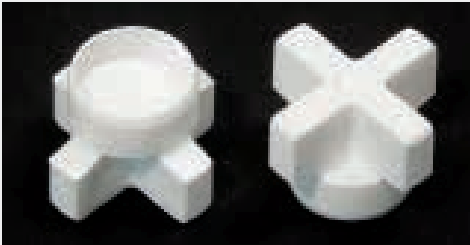

Eliminate Low Head Drainage

The LPS sprinkler series has an optional check valve rated to hold back 7' (2,1m) of elevation change. This helps to eliminate low head drainage and keeps the lines charged to lessen water hammer potential.

SPECIFICATIONS

Operational

- Radius: 2' – 18' (0,6-5,5m)
- Operating pressure range: 20-50 psi (1,4-3,5 Bar)
- Recommended pressure for spray nozzles: 30 psi (2,1 Bar)
- Recommended pressure for rotating nozzles: 40-50 psi (2,8-3,5 Bar)
- Flow by: 0 at 10 psi (0 at 0,7 Bar) or greater
- Infinitely adjustable from 0° to 360°
- Top color-coded nozzles

Dimensions

- Body diameter: 1¼" (32mm)
- Cap diameter: 1⅝" (41,3mm)
- Inlet: ½" (12mm) female-threaded

Options Available

- LPSCV - Check Valve: Maintains up to 7' (2,1m) elevation change

Warranty

- Two years

LPS SERIES MODEL LIST

Model	Description
LPS200	2" (50mm) Pop-up w/o nozzle
LPS208	2" (50mm) Pop-up w/TVAN8 installed
LPS210	2" (50mm) Pop-up w/TVAN10 installed
LPS212	2" (50mm) Pop-up w/TVAN12 installed
LPS215	2" (50mm) Pop-up w/TVAN15 installed
LPS217	2" (50mm) Pop-up w/TVAN17 installed
LPS400	4" (100mm) Pop-up w/o nozzle
LPS408	4" (100mm) Pop-up w/TVAN8 installed
LPS410	4" (100mm) Pop-up w/TVAN10 installed
LPS412	4" (100mm) Pop-up w/TVAN12 installed
LPS415	4" (100mm) Pop-up w/TVAN15 installed
LPS41	4" (100mm) Pop-up w/TVAN17 installed

Specifying Information—LPS Series

LPS-X-XX-X			
<i>Model</i>	<i>Body</i>	<i>Nozzle</i>	<i>Options</i>
LPS	X	XX	CV
LPS—LPS Fixed Spray	2—2" Body 4—4" Body	00—Body Only 08—8' 10—10' 12—12' 15—15' 17—17'	CV—Check Valve
Example: A 4" Fixed-spray Sprinkler with a 10' nozzle, would be specified as: LPS410			



PRECISION™ SERIES SPRAY NOZZLES



FEATURES & BENEFITS

Patented H²O Chip Technology

Each nozzle contains one or more H²O chips that create a high frequency oscillating stream and deliver a precipitation rate of 1" per hour – an industry first – while using up to 35% less water than a standard MPR nozzle.

Pressure-Compensating Versions Available

At a fraction of the cost of a pressure-regulating spray head, pressure-compensating Precision™ Series Spray Nozzles maintain a 1" per hour precipitation rate and minimize misting and water waste that results from higher pressure systems.

Design and Retrofit Effectiveness

The lower flow rate of Precision™ Series Spray Nozzles maximizes design efficiency and helps reduce overall material costs based on the need for fewer valves and controller stations.

Third-Party Performance Validation

Precision™ Series Spray Nozzles* have been tested and validated in the field and at the Center for Irrigation Technology (CIT).

* non-PCD models only



Male-threaded Model



Female-threaded Model

Pressure Compensating Disc (PCD)

The elastomeric PCD adjusts in response to changes in inlet pressure to maintain optimal nozzle performance. Recommended for use on systems operating above 40 psi, PCD models can easily be identified by the red Toro lettering across the top of the nozzle.



Specifying Information-Precision™ Series Spray Nozzle

O-X-XXXX-XXXX-P				
Nozzle	Thread	Radius	Arc	PCD
O	X	XXXX	XXXX	P
0—1" Per Hour	T—Toro Male-Threaded Nozzle Blank—Female-Threaded Nozzle	5—5' 8—8' 10—10' 12—12' 15—15' 4X15—4'X15' (PCD models only) 4X30—4'X30' (PCD models only) 4X9—4'X9' 4X18—4'X18'	60—60° Q—90° T—120° 150—150° H—180° 210—210° TT—240° TQ—270° F-360°—Full-circle LCS—Left Corner RCS—Right Corner SST—Side Strip	P—Pressure Compensating
<p>Example: A female-threaded Precision™ Series Spray with a spray radius of 12' and a 90° arc would be specified as: 0-12-Q</p> <p>Example 2: A male-threaded Pressure-Compensating Precision™ Series Spray with a spray radius of 10' and a 180° arc would be specified as 0-T-10-HP</p>				

*Not available with Pressure Compensation.

SPECIFICATIONS

Operational

- Radius: 5'-15'
- Operating pressure range: 20-75 psi
- Recommended operating pressure:
Non-Pressure Compensating—30 psi,
Pressure Compensating—50 psi
- Flow Rate: 0.04-2.4 gpm
- Nozzle trajectory:
 - 5': 5°
 - 8': 10°
 - 10': 15°
 - 12': 20°
 - 15': 27°
 - Corner and Side Strips: 20°

Warranty

- Two years



Laboratory and third party independent field testing show efficiency to be 15-20% higher than competitive nozzles at 15 feet or less.

PRECISION™ SERIES SPRAY NOZZLE MODEL LIST

5' NOZZLE (RED)			8' NOZZLE (GREEN)		
Male	Female	Pattern	Male	Female	Pattern
O-T-5-60	O-5-60	60° Arc	O-T-8-60	O-8-60	60° Arc
O-T-5-Q	O-5-Q	90° Arc	O-T-8-Q	O-8-Q	90° Arc
O-T-5-T	O-5-T	120° Arc	O-T-8-T	O-8-T	120° Arc
O-T-5-150	O-5-150	150° Arc	O-T-8-150	O-8-150	150° Arc
O-T-5-H	O-5-H	180° Arc	O-T-8-H	O-8-H	180° Arc
O-T-5-210	O-5-210	210° Arc	O-T-8-210	O-8-210	210° Arc
O-T-5-TT	O-5-TT	240° Arc	O-T-8-TT	O-8-TT	240° Arc
O-T-5-TQ	O-5-TQ	270° Arc	O-T-8-TQ	O-8-TQ	270° Arc
O-T-5-F	O-5-F	360° Arc	O-T-8-F	O-8-F	360° Arc
10' NOZZLE (BLUE)			12' NOZZLE (BROWN)		
O-T-10-60	O-10-60	60° Arc	O-T-12-60	O-12-60	60° Arc
O-T-10-Q	O-10-Q	90° Arc	O-T-12-Q	O-12-Q	90° Arc
O-T-10-T	O-10-T	120° Arc	O-T-12-T	O-12-T	120° Arc
O-T-10-150	O-10-150	150° Arc	O-T-12-150	O-12-150	150° Arc
O-T-10-H	O-10-H	180° Arc	O-T-12-H	O-12-H	180° Arc
O-T-10-210	O-10-210	210° Arc	O-T-12-210	O-12-210	210° Arc
O-T-10-TT	O-10-TT	240° Arc	O-T-12-TT	O-12-TT	240° Arc
O-T-10-TQ	O-10-TQ	270° Arc	O-T-12-TQ	O-12-TQ	270° Arc
O-T-10-F	O-10-F	360° Arc	O-T-12-F	O-12-F	360° Arc
15' NOZZLE (BLACK)			SPECIAL PATTERNS (GREY)		
O-T-15-60	O-15-60	60° Arc			
O-T-15-Q	O-15-Q	90° Arc			
O-T-15-T	O-15-T	120° Arc			
O-T-15-150	O-15-150	150° Arc			
O-T-15-H	O-15-H	180° Arc			
O-T-15-210	O-15-210	210° Arc			
O-T-15-TT	O-15-TT	240° Arc			
O-T-15-TQ	O-15-TQ	270° Arc			
O-T-15-F	O-15-F	360° Arc			
			Male	Female	
			O-T-4X9-RCS	O-4X9-RCS	Right Corner
			O-T-4X9-LCS	O-4X9-LCS	Left Corner
			O-T-4X18-SST	O-4X18-SST	Side Strip
			O-T-4X15-RCS	O-4X15-RCS	Right Corner
			O-T-4X15-LCS	O-4X15-LCS	Left Corner
			O-T-4X30-SST	O-4X30-SST	Side Strip

PRESSURE-COMPENSATING

PRECISION™ SERIES SPRAY NOZZLE MODEL LIST

5' NOZZLE (RED)			8' NOZZLE (GREEN)		
Male	Female	Pattern	Male	Female	Pattern
O-T-5-60P	O-5-60P	60° Arc	O-T-8-60P	O-8-60P	60° Arc
O-T-5-QP	O-5-QP	90° Arc	O-T-8-QP	O-8-QP	90° Arc
O-T-5-TP	O-5-TP	120° Arc	O-T-8-TP	O-8-TP	120° Arc
O-T-5-150P	O-5-150P	150° Arc	O-T-8-150P	O-8-150P	150° Arc
O-T-5-HP	O-5-HP	18° Arc	O-T-8-HP	O-8-HP	18° Arc
O-T-5-210P	O-5-210P	210° Arc	O-T-8-210P	O-8-210P	210° Arc
O-T-5-TTP	O-5-TTP	240° Arc	O-T-8-TTP	O-8-TTP	240° Arc
O-T-5-TQP	O-5-TQP	270° Arc	O-T-8-TQP	O-8-TQP	270° Arc
O-T-5-FP	O-5-FP	360° Arc	O-T-8-FP	O-8-FP	360° Arc
10' NOZZLE (BLUE)			12' NOZZLE (BROWN)		
O-T-10-60P	O-10-60P	60° Arc	O-T-12-60P	O-12-60P	60° Arc
O-T-10-QP	O-10-QP	90° Arc	O-T-12-QP	O-12-QP	90° Arc
O-T-10-TP	O-10-TP	120° Arc	O-T-12-TP	O-12-TP	120° Arc
O-T-10-150P	O-10-150P	150° Arc	O-T-12-150P	O-12-150P	150° Arc
O-T-10-HP	O-10-HP	18° Arc	O-T-12-HP	O-12-HP	18° Arc
O-T-10-210P	O-10-210P	210° Arc	O-T-12-210P	O-12-210P	210° Arc
O-T-10-TTP	O-10-TTP	240° Arc	O-T-12-TTP	O-12-TTP	240° Arc
O-T-10-TQP	O-10-TQP	270° Arc	O-T-12-TQP	O-12-TQP	270° Arc
O-T-10-FP	O-10-FP	360° Arc	O-T-12-FP	O-12-FP	360° Arc
15' NOZZLE (BLACK)			SPECIAL PATTERNS (GREY)		
O-T-15-60P	O-15-60P	60° Arc			
O-T-15-QP	O-15-QP	90° Arc			
O-T-15-TP	O-15-TP	120° Arc			
O-T-15-150P	O-15-150P	150° Arc			
O-T-15-HP	O-15-HP	18° Arc			
O-T-15-210P	O-15-210P	210° Arc			
O-T-15-TTP	O-15-TTP	240° Arc			
O-T-15-TQP	O-15-TQP	270° Arc			
O-T-15-FP	O-15-FP	360° Arc			
			Male	Female	
			O-T-4X9-RCSP	O-4X9-RCSP	Right Corner
			O-T-4X9-LCSP	O-4X9-LCSP	Left Corner
			O-T-4X18-SSTP	O-4X18-SSTP	Side Strip
			O-T-4X15-RCSP	O-4X15-RCSP	Right Corner
			O-T-4X15-LCSP	O-4X15-LCSP	Left Corner
			O-T-4X30-SSTP	O-4X30-SSTP	Side Strip

MPR & MPR PLUS SPRAY NOZZLES

FEATURES & BENEFITS

Matched Precipitation Rates

Ensures all nozzles with a common radii apply water at approximately the same rate.

Pre-installed Pressure Compensation Disc

Eliminates excessive misting, conserves water and provides precise flow rates.

Additional Features

- ✓ Customized screens for each nozzle
- ✓ Fine-mesh snap-in filter screens for lower flow nozzles
- ✓ Convenient nozzle packaging – nozzles and screens packed separately
- ✓ Adjustment screw allows up to 25% reduction in radius and complete shutoff

SPECIFICATIONS

Operational

- Operating pressure range: 20-75 psi
- Recommended operating pressure: 30 psi
- Flow Rate: 0.05 – 4.58 gpm
- Nozzle trajectory:
 - 5': 5° - 8': 10° - 10': 17° - 12': 24° - 15': 28°
 - Corner and Side Strips: 17°
 - 8' Flat Spray: 0°

Warranty

- Two years



5' MPR Plus Nozzle 8' MPR Plus Nozzle 8' Flat Spray



10' MPR Plus Nozzle 12' MPR Plus Nozzle Special Patterns

MPR PLUS SPRAY NOZZLES MODEL LIST

Model	Description	Model	Description
5' MPR PLUS NOZZLE (RED)		8' MPR PLUS NOZZLE (GREEN)	
5Q	90° Arc	8Q	90° Arc
5T	120° Arc	8T	120° Arc
5H	180° Arc	8H	180° Arc
5TT	240° Arc	8TT	240° Arc
5TQ	270° Arc	8TQ	270° Arc
5F	360° Arc	8F	360° Arc
8' FLAT SPRAY (BLACK)		10' MPR PLUS NOZZLE (BLUE)	
FSQ	90° Arc	10Q	90° Arc
FSH	180° Arc	10T	120° Arc
FSF	360° Arc	10H	180° Arc
FSQ-LG	90° Arc, low flow	10TT	240° Arc
FSH-LG	180° Arc, low flow	10TQ	270° Arc
FSF-LG	360° Arc, low flow	10F	360° Arc
12' MPR PLUS NOZZLE (BROWN)		15' MPR PLUS NOZZLE (BLACK)	
12Q	90° Arc	15Q	90° Arc
12T	120° Arc	15T	120° Arc
12H	180° Arc	15H	180° Arc
12TT	240° Arc	15TT	240° Arc
12TQ	270° Arc	15TQ	270° Arc
12F	360° Arc	15F	360° Arc
SPECIAL PATTERNS (ORANGE)			
4SST	Side Strip 4'x30'		
4EST	End Strip 4'x15'		
4CST	Center Strip 4'x30'		
9SST	Side Strip 9'x18'		
4SSST	Side Strip 4'x18'		
2SST	Side Strip 2' x 6'		

Specifying Information—MPR Nozzles

XX-XXX-PC		
Radius	Arc	Optional
XXX	XXX	PC
5-5'	Q-90° T-120°	PC—Pressure Compensation
8-8'	H-180°	
10-10'	TT-240° Q-270°	
12-12'	F-360°	
15-15'	EST—End Strip	
	CST—Center Strip SST—Side Strip	
Example: A 570 MPR Plus Nozzle with a spray of 10', 180° arc and pressure compensation, would be specified as: 10-H-PC		

Note: To specify a MPR Plus nozzle with a 570Z sprinkler body, attach the body specification before the above nozzle specification. Do not use PCDs with 570Z PR & 570Z PRX models

PERFORMANCE DATA-MPR PLUS SPRAY NOZZLES

5° SERIES WITH 5° TRAJECTORY (RED)

8° SERIES WITH 10° TRAJECTORY (GREEN)

10° SERIES WITH 17° TRAJECTORY (BLUE)

Arc	Desc.	psi	gpm	Rad	Prec. Rate		Arc	Desc.	psi	gpm	Rad	Prec. Rate		Arc	Desc.	psi	gpm	Rad	Prec. Rate	
					▲	■						▲	■						▲	■
90°	5-Q	20	0.05	4	1.40	1.21	90°	8-Q	20	0.17	7	1.55	1.34	90°	10-Q	20	0.30	9	1.66	1.44
		30	0.09	5	1.61	1.40			30	0.24	8	1.68	1.45			30	0.40	10	1.79	1.55
		40	0.12	6	1.78	1.54			40	0.26	9	1.61	1.39			40	0.50	11	1.85	1.60
	5-Q-PC	50	0.15	6	1.86	1.62		8-Q-PC	50	0.29	9	1.60	1.39		10-Q-PC	50	0.60	12	1.86	1.62
		30-40	0.09	5	1.61	1.40			30-40	0.22	8	1.54	1.33			30-40	0.33	10	1.48	1.28
		40-75	0.10	5	1.79	1.55			40-75	0.25	8	1.75	1.51			40-75	0.37	10	1.66	1.43
120°	5-T	20	0.07	4	1.47	1.27	120°	8-T	20	0.23	7	1.58	1.36	120°	10-T	20	0.42	9	1.74	1.51
		30	0.12	5	1.61	1.40			30	0.30	8	1.57	1.36			30	0.52	10	1.75	1.51
		40	0.16	6	1.78	1.54			40	0.36	9	1.67	1.45			40	0.65	11	1.80	1.56
	5-T-PC	50	0.20	6	1.86	1.62		8-T-PC	50	0.40	9	1.66	1.44		10-T-PC	50	0.75	12	1.75	1.51
		30-40	0.12	5	1.61	1.40			30-40	0.29	8	1.52	1.32			30-40	0.44	10	1.48	1.28
		40-75	0.13	5	1.79	1.55			40-75	0.35	8	1.84	1.59			40-75	0.50	10	1.68	1.45
180°	5-H	20	0.10	4	1.40	1.21	180°	8-H	20	0.37	8	1.47	1.27	180°	10-H	20	0.60	9	1.66	1.44
		30	0.19	5	1.70	1.47			30	0.50	8	1.75	1.51			30	0.71	10	1.59	1.38
		40	0.23	6	1.70	1.47			40	0.58	9	1.80	1.56			40	0.85	11	1.57	1.36
	5-H-PC	50	0.27	6	1.68	1.45		8-H-PC	50	0.65	9	1.80	1.56		10-H-PC	50	0.99	12	1.65	1.43
		30-40	0.18	5	1.61	1.40			30-40	0.44	8	1.54	1.33			30-40	0.66	10	1.48	1.28
		40-75	0.20	5	1.79	1.55			40-75	0.50	8	1.75	1.51			40-75	0.75	10	1.68	1.45
240°	5-TT	20	0.15	4	1.57	1.36	240°	8-TT	20	0.56	7	1.92	1.66	240°	10-TT	20	0.71	9	1.47	1.27
		30	0.25	5	1.68	1.45			30	0.70	8	1.84	1.59			30	0.97	10	1.63	1.41
		40	0.30	6	1.66	1.44			40	0.80	9	1.86	1.61			40	1.10	11	1.67	1.45
	5-TT-PC	50	0.35	6	1.63	1.41		8-TT-PC	50	0.88	9	1.82	1.58		10-TT-PC	50	1.19	11	1.65	1.43
		30-40	0.23	5	1.54	1.34			30-40	0.59	8	1.55	1.34			30-40	0.89	10	1.49	1.29
		40-75	0.27	5	1.81	1.57			40-75	0.70	8	1.84	1.59			40-75	1.00	10	1.68	1.45
270°	5-TQ	20	0.20	4	1.86	1.61	270°	8-TQ	20	0.63	7	1.92	1.66	270°	10-TQ	20	0.82	9	1.51	1.31
		30	0.29	5	1.73	1.50			30	0.76	8	1.77	1.53			30	1.04	10	1.55	1.34
		40	0.34	6	1.68	1.45			40	0.86	9	1.78	1.54			40	1.20	11	1.62	1.41
	5-TQ-PC	50	0.40	6	1.66	1.44		8-TQ-PC	50	0.93	9	1.71	1.48		10-TQ-PC	50	1.35	11	1.66	1.44
		30-40	0.26	5	1.55	1.34			30-40	0.64	8	1.49	1.29			30-40	0.99	10	1.48	1.28
		40-75	0.29	5	1.73	1.50			40-75	0.70	8	1.63	1.41			40-75	1.09	10	1.63	1.41
360°	5-F	20	0.25	4	1.75	1.51	360°	8-F	20	0.74	7	1.69	1.46	360°	10-F	20	1.11	9	1.72	1.49
		30	0.38	5	1.70	1.47			30	1.00	8	1.75	1.51			30	1.49	10	1.67	1.44
		40	0.45	6	1.66	1.44			40	1.16	9	1.80	1.56			40	1.61	11	1.63	1.42
	5-F-PC	50	0.53	6	1.65	1.43		8-F-PC	50	1.30	9	1.80	1.56		10-F-PC	50	1.85	11	1.71	1.48
		30-40	0.35	5	1.57	1.36			30-40	0.85	8	1.49	1.29			30-40	1.33	10	1.49	1.29
		40-75	0.39	5	1.75	1.51			40-75	1.00	8	1.75	1.51			40-75	1.51	10	1.69	1.46

12° SERIES WITH 24° TRAJECTORY (BROWN)

15° SERIES WITH 28° TRAJECTORY (BLACK)

SPECIAL PATTERNS (ORANGE)

Arc	Desc.	psi	gpm	Rad	Prec. Rate		Arc	Desc.	psi	gpm	Rad	Prec. Rate		Pattern	Desc.	psi	gpm	Special Patterns		Prec. Rate*	
					▲	■						▲	■					Width	Length		
90°	12-Q	20	0.40	11	1.48	1.28	90°	15-Q	20	0.68	14	1.55	1.34	■	4-EST	20	0.38	3'	x	12'	2.03
		30	0.50	12	1.55	1.35			30	0.85	15	1.69	1.46			30	0.45	4'	x	15'	1.44
		40	0.60	13	1.64	1.42			40	1.04	16	1.82	1.57			40	0.53	5'	x	18'	1.13
	12-Q-PC	50	0.63	13	1.67	1.44		15-Q-PC	50	1.23	16	2.15	1.86		4-EST-PC	50	0.60	6'	x	20'	0.96
		30-40	0.48	12	1.49	1.29			30-40	0.75	15	1.49	1.29			30-40	0.43	4'	x	15'	1.38
		40-75	0.53	12	1.65	1.43			40-75	0.81	15	1.61	1.40			40-75	0.50	4'	x	15'	1.61
120°	12-T	20	0.57	11	1.58	1.37	120°	15-T	20	0.95	14	1.75	1.52	●	4-CST	20	0.75	3'	x	24'	2.01
		30	0.72	12	1.68	1.45			30	1.10	15	1.64	1.42			30	0.90	4'	x	30'	1.44
		40	0.87	13	1.87	1.62			40	1.30	16	1.82	1.57			40	1.04	4'	x	30'	1.67
	12-T-PC	50	0.97	13	1.93	1.67		15-T-PC	50	1.45	16	2.03	1.75		4-CST-PC	50	1.16	4'	x	31'	1.80
		30-40	0.64	12	1.49	1.29			30-40	1.00	15	1.49	1.29			30-40	0.86	4'	x	30'	1.38
		40-75	0.70	12	1.63	1.41			40-75	1.10	15	1.64	1.42			40-75	1.00	4'	x	30'	1.61
180°	12-H	20	0.95	11	1.76	1.52	180°	15-H	20	1.37	13	1.79	1.55	■	9-SST	20	1.00	9'	x	18'	1.19
		30	1.09	12	1.69	1.47			30	1.65	15	1.66	1.44			30	1.20	9'	x	18'	1.43
		40	1.30	13	1.72	1.49			40	2.02	16	1.77	1.53			40	1.38	9'	x	20'	1.48
	12-H-PC	50	1.55	14	1.77	1.53		15-H-PC	50	2.14	16	1.87	1.62		9-SST-PC	50	1.55	10'	x	22'	1.36
		30-40	0.96	12	1.49	1.29			30-40	1.50	15	1.49	1.29			30-40	1.10	9'	x	18'	1.31
		40-75	1.05	12	1.63	1.41			40-75	1.65	15	1.64	1.42			40-75	1.20	9'	x	18'	1.43
240°	12-TT	20	1.12	11	1.55	1.35	240°	15-TT	20	1.78	14	1.59	1.38	■	4-SST	20	0.65	4'	x	24'	1.30
		30	1.45	12	1.69	1.46			30	2.20	15	1.64	1.42			30	0.90	4'	x	30'	1.44
		40	1.63	13	1.75	1.52			40	2.66	16	1.74	1.51			40	1.04	4'	x	32'	1.56
	12-TT-PC	50	1.80	13	1.79	1.55		15-TT-PC	50	2.84	16	1.86	1.61		4-SST-PC	50	1.16	5'	x	33'	1.35
		30-40	1.28	12	1.49	1.29			30-40	2.00	15	1.49	1.29			30-40	0.88	4'	x	30'	1.41
		40-75	1.40	12	1.63	1.41			40-75	2.20	15	1.64	1.42			40-75	1.00	4'	x	30'	1.61
270°	12-TQ	20	1.05	11	1.42	1.23	270°	15-TQ	20	2.10	13	1.85	1.61	■	2-SST	20	0.08	2'	x	5'	1.54
		30	1.55	12	1.61	1.39			30	2.60	15	1.72	1.49			30	0.09	2'	x	6'	1.44
		40	1.65	13	1.58	1.36			40	3.00	16	1.86	1.61			40	0.10	2'	x	7'	1.38
	12-TQ-PC	50	1.80	13	1.59	1.38		15-TQ-PC	50	3.40	16	1.98	1.72		2-SST-PC	50	0.12	3'	x	7'	1.10
		30-40	1.44	12	1.49	1.29			30-40	2.30	15	1.53	1.32			30-40	0.09	2'	x	6'	1.44
		40-75	1.60	12	1.66	1.44			40-75	2.50	15	1.66	1.44			40-75	0.10	2'	x	6'	1.61
360°	12-F	20	1.67	11	1.54	1.34	360°	15-F	20	2.85	13	1.89	1.63	■	4S-SST	20	0.46	4'	x	17'	1.30
		30	2.19	12	1.70	1.47			30	3.60	15	1.79	1.55			30	0.55	4'	x	18'	1.47
		40	2.35	13	1.68	1.46			40	4.20	16	1.84	1.59			40	0.63	4'	x	19'	1.60
	12-F-PC	50	2.70	13	1.79	1.55		15-F-PC	50	4.58	16	2.00	1.73		4S-SST-PC	50	0.71	5'	x	19'	1.44
		30-40	1.92	12	1.49	1.29			30-40	3.00	15	1.49	1.29			30-40	0.50	4'	x	18'	1.34
		40-75	2.10	12	1.63	1.41			40-75	3.30	15	1.64	1.42			40-75	0.59	4'	x	18'	1.58

TVAN VARIABLE ARC NOZZLES

FEATURES & BENEFITS

Matched Precipitation Rates

Ensures all nozzles with a common radii apply water at approximately the same rate.

Unique Grip and Turn Adjustment

Requires no tools and makes arc setting fast and simple. Adjust from the top of the nozzle – wet or dry.

Infinitely Adjustable from 0° - 360°

The TVAN provides a variety of arc settings to precisely match any terrain and reduces inventory by meeting the needs of any size or shape landscape.

Five Color-coded Nozzles

Allows for quick and easy identification even when retracted.

Additional Features

- ✓ Stainless steel adjustment screw allows up to 25% radius reduction
- ✓ Nozzle arc adjustment opens from a fixed left stop position indicated by an arrow on the top



8' Variable Arc Nozzle



10' Variable Arc Nozzle



12' Variable Arc Nozzle



15' Variable Arc Nozzle



17' Variable Arc Nozzle

SPECIFICATIONS

Operational

- Radius: 8' to 17'
- Operating pressure range: 20-50 psi
- Recommended operating pressure: 30 psi

Warranty

- Two years



Easy Grip Top
The easy grip top makes arc adjustment from 0°-360° a snap

TVAN VARIABLE ARC NOZZLES MODEL LIST

Model	Description
TVAN8	8' Variable Arc Pattern
TVAN10	10' Variable Arc Pattern
TVAN12	12' Variable Arc Pattern
TVAN15	15' Variable Arc Pattern
TVAN17	17' Variable Arc Pattern

TVAN VARIABLE ARC NOZZLE PERFORMANCE DATA

Pattern	psi	8' Series (Green)				10' Series (Blue)				12' Series (Brown)				15' Series (Black)				17' Series (Gray)			
		gpm	Rad	Precip. Rate		gpm	Rad	Precip. Rate		gpm	Rad	Precip. Rate		gpm	Rad	Precip. Rate		gpm	Rad	Precip. Rate	
				▲	■			▲	■			▲	■			▲	■			▲	■
90°	20	0.58	7	5.26	4.56	0.59	9	3.24	2.81	0.76	10	3.38	2.93	1.06	15	2.09	1.81	1.25	16	2.17	1.88
	30	0.71	8	4.93	4.27	0.72	10	3.20	2.77	0.93	12	2.87	2.49	1.29	15	2.55	2.21	1.46	17	2.25	1.95
	40	0.82	9	4.50	3.90	0.84	10	3.73	3.24	1.07	12	3.30	2.86	1.49	16	2.59	2.24	1.68	18	2.31	2.00
	50	0.92	9	5.05	4.38	0.94	10	4.18	3.62	1.21	13	3.18	2.76	1.66	16	2.88	2.50	1.87	18	2.57	2.22
180°	20	0.81	7	3.67	3.18	0.94	9	2.58	2.24	1.35	10	3.00	2.60	1.71	14	1.94	1.68	1.95	15	1.93	1.67
	30	0.99	8	3.44	2.98	1.15	10	2.56	2.21	1.65	12	2.55	2.21	2.08	15	2.05	1.78	2.38	17	1.83	1.59
	40	1.15	8	3.99	3.46	1.33	10	2.96	2.56	1.91	12	2.95	2.55	2.40	15	2.37	2.05	2.74	17	2.11	1.83
	50	1.28	9	3.51	3.04	1.49	10	3.31	2.87	2.13	13	2.80	2.43	2.68	15	2.65	2.29	3.06	18	2.10	1.82
270°	20	1.08	7	3.27	2.83	1.37	9	2.51	2.17	1.90	11	2.33	2.02	2.41	14	1.82	1.58	2.69	14	2.03	1.76
	30	1.33	8	3.08	2.67	1.67	10	2.47	2.14	2.32	12	2.39	2.07	2.94	15	1.94	1.68	3.28	17	1.68	1.46
	40	1.53	8	3.54	3.07	1.92	10	2.85	2.47	2.68	12	2.76	2.39	3.38	15	2.23	1.93	3.76	17	1.93	1.67
	50	1.70	9	3.11	2.69	2.15	10	3.19	2.76	2.99	12	3.08	2.67	3.77	16	2.18	1.89	4.19	18	1.92	1.66
360°	20	1.25	7	2.84	2.46	1.73	9	2.37	2.06	2.27	10	2.52	2.19	2.69	13	1.77	1.53	3.05	17	1.17	1.02
	30	1.52	8	2.64	2.29	2.11	10	2.35	2.03	2.77	12	2.14	1.85	3.26	15	1.61	1.40	3.73	17	1.43	1.24
	40	1.75	9	2.40	2.08	2.42	10	2.69	2.33	3.12	12	2.41	2.09	3.79	15	1.87	1.62	4.26	18	1.46	1.27
	50	1.96	9	2.69	2.33	2.69	10	2.99	2.59	3.47	12	2.68	2.32	4.33	16	1.88	1.63	4.71	18	1.62	1.40

Shaded data indicates optimal operating pressure. Radius shown in feet. Data based on 360°.

Specifying Information—TVAN

TVANXX	
Model	Radius
TVAN	XX
TVAN—Toro Variable Arc Nozzle	8—8' Variable Arc Pattern 10—10' Variable Arc Pattern 12—12' Variable Arc Pattern 15—15' Variable Arc Pattern 17—17' Variable Arc Pattern

Example: A TVAN8 nozzle, would be specified as: **TVAN8**



I-PRO™ NOZZLES

FEATURES & BENEFITS

Matched Precipitation Rate

Ensures even water distribution within each family.

Low Flow Rates

Allow for more sprinklers to be installed on the same zone.

Color-coded Top

For quick and easy radius identification.

Female-threaded

Compatible with any male-threaded riser in the industry.

Ribbed-edge Design

Provides for a non-slip grip.



5'



8'



10'



12'



15'

I-PRO NOZZLE SERIES

Model	Description	Model	Description
IPN-5F	360° Arc	IPN-12H	180° Arc
IPN-5H	180° Arc	IPN-12T	120° Arc
IPN-5T	120° Arc	IPN-12Q	90° Arc
IPN-5Q	90° Arc	IPN-15F	360° Arc
IPN-8F	360° Arc	IPN-15TQ	270° Arc
IPN-8H	180° Arc	IPN-15TT	240° Arc
IPN-8T	120° Arc	IPN-15H	180° Arc
IPN-8Q	90° Arc	IPN-15T	120° Arc
IPN-10F	360° Arc	IPN-15Q	90° Arc
IPN-10H	180° Arc	IPN-9EST	End strip, 4' x 9'
IPN-10T	120° Arc	IPN-9CST	Center strip, 4' x 18'
IPN-10Q	90° Arc	IPN-9SST	Side strip, 4' x 18'
IPN-12F	360° Arc	IPN-15EST	End strip, 4' x 15'
IPN-12TQ	270° Arc	IPN-15CST	Center strip, 4' x 30'
IPN-12TT	240° Arc	IPN-15SST	Side strip, 4' x 18'



5', 8' and 10' nozzles are not available in TT and TQ arc settings

Additional Features

- ✓ Stainless steel radius adjustment screw allows for up to 25% in-field reduction

PERFORMANCE DATA I-PRO NOZZLE SERIES

5' SERIES WITH 0° TRAJECTORY (RED)

Nozzle	psi	gpm	Rad	Prec. Rate	
				▲	■
IPN-5F	20	0.27	4	1.87	1.62
	30	0.41	5	1.82	1.58
	40	0.49	6	1.50	1.30
	50	0.57	6	1.77	1.53
IPN-5H	20	0.11	4	1.46	1.27
	30	0.20	5	1.78	1.54
	40	0.24	6	1.49	1.29
IPN-5T	20	0.08	4	1.58	1.37
	30	0.13	5	1.73	1.50
	40	0.17	6	1.61	1.39
IPN-5Q	20	0.06	4	1.54	1.34
	30	0.10	5	1.78	1.54
	40	0.13	6	1.65	1.43
	50	0.17	6	2.06	1.78

8' SERIES WITH 5° TRAJECTORY (GREEN)

Nozzle	psi	gpm	Rad	Prec. Rate	
				▲	■
IPN-8F	20	0.77	7	1.75	1.51
	30	1.04	8	1.81	1.56
	40	1.21	9	1.66	1.43
	50	1.35	9	1.86	1.61
IPN-8H	20	0.38	7	1.75	1.51
	30	0.52	8	1.81	1.56
	40	0.60	9	1.66	1.43
IPN-8T	20	0.26	8	1.77	1.54
	30	0.34	8	1.77	1.53
	40	0.41	9	1.68	1.45
IPN-8Q	20	0.18	7	1.67	1.45
	30	0.26	8	1.81	1.56
	40	0.28	9	1.55	1.34
	50	0.31	9	1.72	1.49

10' SERIES WITH 12° TRAJECTORY (BLUE)

Nozzle	psi	gpm	Rad	Prec. Rate	
				▲	■
IPN-10F	20	1.22	9	1.68	1.45
	30	1.64	10	1.82	1.58
	40	1.77	11	1.63	1.41
	50	2.04	12	1.57	1.36
IPN-10H	20	0.68	9	1.88	1.63
	30	0.81	10	1.80	1.56
	40	0.97	11	1.78	1.54
IPN-10T	20	0.43	9	1.76	1.53
	30	0.53	10	1.77	1.53
	40	0.66	11	1.83	1.58
IPN-10Q	20	0.30	9	1.65	1.43
	30	0.40	10	1.78	1.54
	40	0.50	11	1.84	1.59
	50	0.60	11	1.85	1.60

12' SERIES WITH 23° TRAJECTORY (BROWN)

Nozzle	psi	gpm	Rad	Prec. Rate	
				▲	■
IPN-12F	20	0.40	11	1.48	1.28
	30	0.50	12	1.55	1.35
	40	0.60	13	1.64	1.42
	50	0.63	13	1.67	1.44
IPN-12TQ	20	0.57	11	1.58	1.37
	30	0.72	12	1.68	1.45
	40	0.87	13	1.87	1.62
IPN-12TT	20	0.97	13	1.93	1.67
	20	0.95	11	1.76	1.52
	30	1.09	12	1.69	1.47
IPN-12TH	40	1.30	13	1.72	1.49
	50	1.55	14	1.77	1.53
	20	1.12	11	1.55	1.35
IPN-12H	30	1.45	12	1.69	1.46
	40	1.63	13	1.75	1.52
	50	1.80	13	1.79	1.55
IPN-12T	20	1.05	11	1.42	1.23
	30	1.55	12	1.61	1.39
	40	1.65	13	1.58	1.36
IPN-12Q	50	1.80	13	1.59	1.38
	20	1.67	11	1.54	1.34
	30	2.19	12	1.70	1.47
	40	2.35	13	1.68	1.46
	50	2.70	13	1.79	1.55

15' SERIES WITH 27° TRAJECTORY (BLACK)

Nozzle	psi	gpm	Rad	Prec. Rate	
				▲	■
IPN-15F	20	2.95	14	1.67	1.45
	30	3.73	15	1.84	1.60
	40	4.35	16	1.89	1.64
	50	4.75	16	2.06	1.78
IPN-15TQ	20	2.23	14	1.68	1.46
	30	2.76	15	1.81	1.57
	40	3.18	16	1.84	1.59
IPN-15TT	50	3.61	16	2.08	1.80
	20	1.95	13	1.66	1.44
	30	2.41	15	1.79	1.55
IPN-15TH	40	2.91	16	1.90	1.64
	50	3.11	16	2.03	1.75
	20	1.51	14	1.71	1.48
IPN-15H	30	1.82	15	1.80	1.56
	40	2.23	16	1.93	1.68
	50	2.36	16	2.05	1.77
IPN-15T	20	1.03	13	1.75	1.51
	30	1.19	15	1.76	1.53
	40	1.41	16	1.83	1.59
IPN-15Q	50	1.57	16	2.04	1.77
	20	0.73	13	1.65	1.43
	30	0.91	15	1.80	1.56
	40	1.11	16	1.93	1.67
	50	1.32	16	2.29	1.98

SPECIAL PATTERNS

9' Series with 20° Trajectory

Nozzle	psi	gpm	Special Patterns		
			Width	Length	
IPN-9EST	20	0.41	3'	x	8'
	30	0.45	4'	x	9'
	40	0.48	5'	x	10'
IPN-9CST	20	0.85	3'	x	16'
	30	0.90	4'	x	18'
	40	0.97	5'	x	20'
IPN-9SST	20	0.85	3'	x	16'
	30	0.90	4'	x	18'
	40	0.97	5'	x	20'

15' Series with 21° Trajectory

Nozzle	psi	gpm	Special Patterns		
			Width	Length	
IPN-15EST	20	0.41	3'	x	8'
	30	0.45	4'	x	9'
	40	0.48	5'	x	10'
IPN15CST	20	0.85	3'	x	16'
	30	0.90	4'	x	18'
	40	0.97	5'	x	20'
IPN15SST	20	0.85	3'	x	16'
	30	0.90	4'	x	18'
	40	0.97	5'	x	20'

- Square spacing based on 50% diameter of throw
- ▲ Triangle spacing based on 50% diameter of throw

SPECIFICATIONS

Operational

- Flow rate: 0.6-4.6 GPM
- Recommended operating pressure: 30 psi
- Maximum operating pressure: 75 psi

Warranty

- Five years

Specifying Information — I-PRO Nozzle Series

IPN-XX-XXX		
Model	Radius	Arc
XXXX	XX	XXX
IPN - I-PRO Nozzles Series	5 - 5'	Q - 90°
	8 - 8'	T - 120°
	9 - 9'*	H - 180°
	10 - 10'	TT - 240°
	12 - 12'	TQ - 270°
	15 - 15'	F - 360°
		EST - end strip
		CST - center strip
		SST - side strip
Example: An I-PRO Series nozzle with a spray of 15', 180° arc = IPN-15H		

*Specialty only



PRO-VAN NOZZLES

FEATURES & BENEFITS

Fully Adjustable Arc – From 0° to 360°

Reduces inventory by meeting the needs of any size or shape landscape.

Precision Adjustment

Eliminates dry spots on lawns and reduces water waste on sidewalks, etc..

Exclusive “Smart Grip” Head Design

Requires no tools and provides the industry’s easiest arc adjustment – even when wet.

Compatible with Any Male-threaded Riser In the Industry

Reduces inventory requirements.

Visible Left-stop Arrow On Top of Nozzle

Ensures setting accuracy.



8'



10'



12'



15'







17'

Additional Features





- ✓ Color-coded for easy radius identification
- ✓ Nozzles ship set to 0°
- ✓ Stainless steel radius adjustment screw allows for up to 25% radius reduction

PERFORMANCE DATA PRO VAN SERIES





8' SERIES WITH 5° TRAJECTORY (GREEN)

Nozzle	psi	gpm	Rad	Prec. Rate	
				▲	■
360° 	20	1.72	8	2.99	2.59
	30	2.13	8	3.70	3.20
	40	2.48	9	4.31	3.73
	50	2.78	9	4.83	4.18
270° 	20	1.36	8	3.15	2.73
	30	1.65	9	3.82	3.31
	40	1.89	9	4.38	3.79
	50	2.13	9	4.93	4.27
180° 	20	0.87	9	3.02	2.62
	30	1.07	9	3.72	3.22
	40	1.23	9	4.27	3.70
	50	1.38	9	4.79	4.15
90° 	20	0.53	9	3.68	3.19
	30	0.64	10	4.45	3.85
	40	0.72	10	5.00	4.33
	50	0.78	10	5.42	4.69





10' SERIES WITH 10° TRAJECTORY (BLUE)

Nozzle	psi	gpm	Rad	Prec. Rate	
				▲	■
360° 	20	1.98	10	2.20	1.91
	30	2.41	10	2.68	2.32
	40	3.19	11	3.55	3.07
	50	3.59	12	3.99	3.46
270° 	20	1.60	10	2.37	2.05
	30	1.95	11	2.88	2.50
	40	2.26	12	3.34	2.89
	50	2.52	12	3.73	3.23
180° 	20	1.13	10	2.51	2.18
	30	1.38	11	3.07	2.66
	40	1.58	12	3.51	3.04
	50	1.77	12	3.93	3.41
90° 	20	0.62	11	2.76	2.39
	30	0.77	12	3.42	2.96
	40	0.89	12	3.96	3.43
	50	1.00	13	4.45	3.85





12' SERIES WITH 15° TRAJECTORY (BROWN)

Nozzle	psi	gpm	Rad	Prec. Rate	
				▲	■
360° 	20	2.26	11	1.74	1.51
	30	2.79	12	2.15	1.86
	40	3.20	13	2.47	2.14
	50	3.62	13	2.79	2.42
270° 	20	1.85	11	1.90	1.65
	30	2.29	12	2.36	2.04
	40	2.64	13	2.72	2.35
	50	2.98	13	3.07	2.66
180° 	20	1.33	11	2.05	1.78
	30	1.63	12	2.52	2.18
	40	1.89	13	2.92	2.53
	50	2.12	14	3.27	2.83
90° 	20	0.75	12	2.32	2.01
	30	0.93	13	2.87	2.49
	40	1.06	14	3.27	2.83
	50	1.21	14	3.74	3.24

15' SERIES WITH 20° TRAJECTORY (BLACK)

Nozzle	psi	gpm	Rad	Prec. Rate	
				▲	■
360° 	20	2.76	14	1.36	1.18
	30	3.35	15	1.65	1.43
	40	3.87	15	1.91	1.66
	50	4.31	16	2.13	1.84
270° 	20	2.36	14	1.55	1.35
	30	2.89	15	1.90	1.65
	40	3.30	16	2.17	1.88
	50	3.37	16	2.46	2.13
180° 	20	1.70	15	1.68	1.45
	30	2.09	16	2.06	1.79
	40	2.42	16	2.39	2.07
	50	2.71	17	2.68	2.32
90° 	20	0.99	15	1.96	1.69
	30	1.20	16	2.37	2.05
	40	1.40	17	2.77	2.40
	50	1.56	17	3.08	2.67

17' SERIES WITH 26° TRAJECTORY (GRAY)

Nozzle	psi	gpm	Rad	Prec. Rate	
				▲	■
360° 	20	2.90	14	1.12	0.97
	30	3.60	16	1.38	1.20
	40	4.10	17	1.58	1.37
	50	4.60	17	1.77	1.53
270° 	20	2.50	14	1.28	1.11
	30	3.10	16	1.59	1.38
	40	3.60	17	1.85	1.60
	50	4.00	17	2.05	1.78
180° 	20	1.90	15	1.46	1.27
	30	2.40	17	1.85	1.60
	40	2.70	17	2.08	1.80
	50	3.00	18	2.31	2.00
90° 	20	1.20	15	1.85	1.60
	30	1.50	17	2.31	2.00
	40	1.70	18	2.62	2.26
	50	1.90	18	2.92	2.53

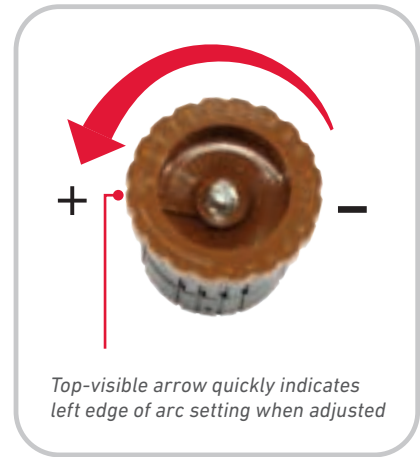

■ Square spacing based on 50% diameter of throw
▲ Triangle spacing based on 50% diameter of throw

PRO-VAN SERIES

Model	Description
PRO-VAN8	8' variable arc pattern
PRO-VAN10	10' variable arc pattern
PRO-VAN12	12' variable arc pattern
PRO-VAN15	15' variable arc pattern
PRO-VAN17	17' variable arc pattern

Specifying Information — PRO VAN Series

PRO-VAN-XX		
Model	Radius	Arc
PRO - PRO-VAN Series	8 - 8' 10 - 10' 12 - 12' 15 - 15' 17 - 17'	VAN - Variable arc

Example: A Pro-VAN Series nozzle with a 12' radius = **PRO-VAN12**

SPECIFICATIONS

Operational

- Flow rate: 0.53-4.6 GPM
- Recommended operating pressure: 30 psi
- Maximum operating pressure: 75 psi

Warranty

- Five years

PRESSURE-COMPENSATING FLOOD BUBBLERS



SPECIFICATIONS

Operational

- Operating pressure range: 20-75 psi
Maximum pressure: 75 psi
- Flow Rate: Adjustable: 0-2.0 gpm
Fixed Flow: 0.25, 0.50 and 1.0 gpm
- Flow Adjustment Screw (ADJ model only)
- Compatible with shrub adapter, 570Z Series Spray Bodies, risers and riser extenders

Warranty

- Two years



FLOOD BUBBLER PERFORMANCE DATA

Pattern	Model No.	gpm @ 40 psi	gpm @ 50 psi	gpm @ 60 psi
Flood ●	89-1727	0.25	0.25	0.25
	89-1729	0.45	0.50	0.50
	89-1731	0.95	1.00	1.00
	89-1733	1.90	2.00	2.00

PRESSURE-COMPENSATING FLOOD BUBBLERS MODEL LIST

Model	Description
89-1727 (FB-25-PC)	0.25 gpm
89-1729 (FB-50-PC)	0.50 gpm
89-1731 (FB-100-PC)	1.00 gpm
89-1733 (FB-200-ADJ-PC)	Adjustable gpm

500 SERIES BUBBLERS



SPECIFICATIONS

Operational

- Operating pressure range:
 - Flood: 15-75 psi
 - Stream: 10-75 psi
 Maximum pressure: 75 psi
- Flow Rate:
 - Flood: 1.7 – 2.7 gpm
 - Stream: 1.08 – 3.70 gpm
- Inlet: 1/2" female thread
- Attaches directly to risers
- Radius adjusts up to 50%

Warranty

- Two years



ADJUSTABLE FLOOD BUBBLER NOZZLE PERFORMANCE DATA

Pattern	Model No.	psi	gpm
Universal Flood ●	514-20	15	1.70
		20	2.00
		25	2.20
		30	2.40
		35	2.50
		40	2.70

500 SERIES ADJUSTABLE STREAM BUBBLER NOZZLE PERFORMANCE DATA

Pattern	Model No.	10 psi		20 psi		30 psi		40 psi	
		gpm	Rad	gpm	Rad	gpm	Rad	gpm	Rad
2/60°	511-30	1.08	10	1.52	14	1.87	16	2.10	17
4/60°	512-30	1.50	7	2.11	10	2.58	11	2.98	13
6/60°	514-30	1.89	6	2.61	8	3.20	10	3.70	11
2/180°	516-30	1.08	10	1.52	14	1.87	16	2.10	17

500 SERIES BUBBLERS MODEL LIST

Model	Description
511-30	90° Arc, Stream Bubbler
512-30	180° Arc, Stream Bubbler
514-30	360° Arc, Stream Bubbler
516-30	180° Arc, 2-stream Bubbler
514-20	Universal Flood Bubbler

Radius shown in feet. Data based on 360°.



STREAM SPRAY NOZZLES

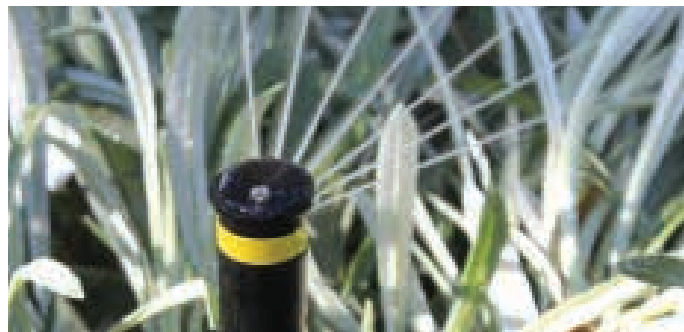

SPECIFICATIONS

Operational

- Operating pressure range: 20-75 psi
- Flow Rate: 0.60 – 2.70 gpm
- Radius adjusts up to 50%
- 10° or 35° Angle
- Non-Rotating

Warranty

- Two years



PERFORMANCE DATA 10° STREAM SPRAY

Pattern	Desc.	psi	gpm	Radius	Prec. Rate*	
					▲	■
90°	10-SSQ	20	0.60	14	1.36	1.18
		30	0.80	16	1.39	1.20
		40	0.92	17	1.42	1.23
		50	1.03	18	1.41	1.22
10-SSQ-PC	40-50	0.70	13	1.84	1.60	
	60-70	0.70	15	1.38	1.20	
	10-SSH	20	1.00	14	1.13	.98
180°	10-SSH	30	1.20	16	1.04	.90
		40	1.38	17	1.06	.92
		50	1.55	18	1.06	.92
10-SSH-PC	40-50	1.40	13	1.84	1.60	
	60-70	1.40	15	1.38	1.20	
360°	10-SSF	20	1.80	14	1.02	.88
		30	2.10	16	.91	.79
		40	2.42	17	.93	.81
		50	2.70	18	.93	.80
		10-SSF-PC	40-50	1.80	13	1.18
60-70	2.00	15	.99	.86		

PERFORMANCE DATA 35° STREAM SPRAY

Pattern	Desc.	psi	gpm	Radius	Prec. Rate*	
					▲	■
90°	35-SSQ	20	0.60	18	.82	.71
		30	0.80	20	.89	.77
		40	0.92	21	.93	.80
		50	1.03	22	.95	.82
35-SSQ-PC	40-50	0.70	17	1.08	.93	
	60-70	0.70	18	.96	.83	
180°	35-SSH	20	1.00	18	.69	.59
		30	1.20	20	.67	.58
		40	1.38	21	.70	.60
		50	1.55	22	.71	.62
35-SSH-PC	40-50	1.40	17	1.08	.93	
	60-70	1.40	18	.96	.83	
360°	35-SSF	20	1.80	18	.62	.54
		30	2.10	20	.58	.51
		40	2.42	21	.61	.53
		50	2.70	22	.62	.54
35-SSF-PC	40-50	1.80	17	.69	.60	
	60-70	2.00	18	.69	.59	

STREAM SPRAY NOZZLES MODEL LIST

Model	Description	Model	Description
NON-PRESSURE COMPENSATING		PRESSURE COMPENSATING	
89-1805	90° Arc	89-1547	90° Arc
89-1804	180° Arc	89-1521	180° Arc
89-1803	360° Arc	89-1519	360° Arc
89-1802	90° Arc	89-1495	90° Arc
89-1801	180° Arc	89-1493	180° Arc
89-1800	360° Arc	89-1491	360° Arc

STREAM BUBBLER NOZZLES

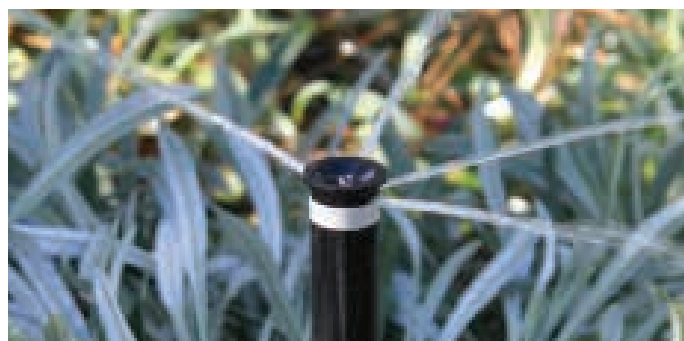

SPECIFICATIONS

Operational

- Operating pressure range: 10-75 psi
- Flow Rate: 0.49 – 2.02 gpm
- Fits all Toro spray bodies, shrub adapters, risers and riser extenders

Warranty

- Two years



STREAM BUBBLER NOZZLE PERFORMANCE DATA

Pattern	Description	10 psi		20 psi		30 psi		40 psi		50 psi		60 psi	
		gpm	Rad	gpm	Rad	gpm	Rad	gpm	Rad	gpm	Rad	gpm	Rad
2/60°	SB-90	0.49	7	0.70	11	0.86	13	1.00	15	1.12	16	1.23	18
2/60°	SB-90-PC2					0.21	1.5	0.22	1.5	0.23	1.5	0.24	1.5
4/60°	SB-180	0.84	5	1.18	9	1.43	12	1.66	14	1.86	16	2.02	17
4/60°	SB-180-PC2					0.46	2.5	0.49	2.5	0.50	2.5	0.51	2.5
6/60°	SB-360	1.18	3	1.63	6	2.00	8	2.29	9	2.55	10	2.82	11
6/60°	SB-360-PC2					0.74	1.5	0.75	1.5	0.76	1.5	0.77	1.5
2/180°	SB-2-180	0.49	7	0.70	11	0.86	13	1.00	15	1.12	16	1.23	18
2/180°	SB-2-180-PC2					0.21	1.5	0.22	1.5	0.23	1.5	0.24	1.5
2/60x2/60°	SB-4-180	0.84	5	1.18	9	1.43	12	1.66	14	1.86	16	2.02	17
2/60x2/60°	SB-4-180-PC2					0.46	2.5	0.49	2.5	0.50	2.5	0.51	2.5

Radius shown in feet. Data based on 360°.

STREAM BUBBLER NOZZLES MODEL LIST

Model	Description
PRESSURE COMPENSATING	
89-7865 (SB-90-PC2)	90° Arc, 2' Radius
89-7875 (SB-180-PC2)	180° Arc, 2' Radius
89-7877 (SB-360-PC2)	360° Arc, 2' Radius
89-7871 (SB-2-180-PC2)	180° Arc, 2 Stream, 2' Radius
89-7873 (SB-4-180-PC2)	180° Arc, 4 Stream, 2' Radius,



533 BUBBLER NOZZLES



533 Bubbler



533NP Bubbler

Key Features

- ✓ Simple twist top flow adjustment
- ✓ True zero flow shut-off
- ✓ Fully adjustable arc and flow rate
- ✓ Heavy-duty ABS material
- ✓ Non-potable option

SPECIFICATIONS

Operational

- Recommended working pressure: 20-40 psi
- Flow rate: 1.36-5.90 GPM
- Maximum operation pressure: 75 psi
- Inlet size: 1/2" female NPT threads

Dimensions

- H: 1 1/8"
- Top diameter: 1 1/16"

Warranty

- Five years

533 BUBBLER SERIES PERFORMANCE DATA

	90° Adjustment	180° Adjustment	270° Adjustment	360° Adjustment
PSI	GPM	GPM	GPM	GPM
15	1.36	2.37	2.85	2.97
20	1.56	2.75	3.31	3.45
25	1.77	3.04	3.71	3.86
30	1.93	3.36	4.05	4.32
35	2.01	3.59	4.37	5.51
40	2.25	3.84	4.70	5.90



SUPER FUNNY PIPE®

FEATURES & BENEFITS

Flexible, Thick-Walled Polyethylene Pipe

Super Funny Pipe is a high-strength poly tubing that solves tough sprinkler installation and replacement problems. It acts as an extension cord between the water line and the sprinkler.

Easy Installation for Problem Areas

One of the most useful and time-saving sprinkler installation aids whether you are installing a new system or replacing an old sprinkler.

SUPER FUNNY PIPE MODEL LIST

Model	Description
850-23	20' Length, 1/2" Polyethylene Pipe
850-24	50' Coil, 1/2" Polyethylene Pipe
850-25	100' Coil, 1/2" Polyethylene Pipe

SUPER FUNNY PIPE FRICTION LOSS DATA

		gpm Flow						
gpm	1	2	3	4	5	6	7	
psi Loss	0.01	0.02	0.06	0.09	0.15	0.21	0.27	

This chart indicates the amount of pressure loss (psi) per foot of Super Funny Pipe at stated flow rates (gpm).

SPECIFICATIONS

Operational

- Maximum pressure: 120 psi
- Cushions sprinklers from external impact
- Connects to sprinklers and Toro fittings

Dimensions

- Wall thickness: .10" ± .01
- Inside diameter: .49" ± 0.005
- Outside diameter: .70"

Warranty

- Two years



SUPER FUNNY PIPE® SWING JOINTS



SUPER FUNNY PIPE SWING JOINTS MODEL LIST

Model	Description
SPFA-585	8" x 1/2"
SPFA-5875	8" x 3/4"
SPFA-5125	12" x 1/2"
SPFA-51275	12" x 3/4"

SPECIFICATIONS

Warranty

- Two years





SUPER BLUE FLEX® SERIES

FEATURES & BENEFITS

Durable, Premium-grade Linear, Low-density Polyethylene

Achieves higher psi strength and performance over time vs. competitive products

Highly Flexible

For ease of use

Easily Unwinds from Center of Coil

For added convenience



Flex pipe 1/2" 100' coil
(EHF1295-010-D)

SPECIFICATIONS

Operational

- Maximum working pressure: 120 psi at 100° F

Dimensions

- Inside diameter: 0.49"
- Outside diameter: 0.68"
- Wall thickness: .095"
- Nominal size: 0.50"
- Coil size: 100'

Warranty

- Five years

Specifying Information — Super Blue Flex® Series

B-FLEX-XX-XXXX		
Model	Length	Fitting
B-FLEX - Blue Flex swing assembly	8 - 8" 12 - 12"	05 - 1/2" male x 1/2" street ell 0575 - 1/2" male x 3/4" street ell
Example: A 12" swing assembly with 3/4" street elbow = B-FLEX12-0575		

SUPER BLUE FLEX® ASSEMBLIES



Available in two popular lengths, these sturdy, flexible assemblies protect spray head risers and pipes from breaking when hit or run over by equipment.

SPECIFICATIONS

Operational

- Operating pressure range: 25-75 psi
- Maximum operating pressure: 85 psi
- Pressure-tested to 120 psi

Warranty

- Five years

SUPER BLUE FLEX ASSEMBLY FRICTION LOSS DATA

gpm	gpm Flow						
	1	2	3	4	5	6	7
B-FLEX8-05	0.04	0.11	0.27	0.47	0.85	1.22	1.78
B-FLEX12-05	0.05	0.15	0.36	0.62	1.13	1.62	2.37
B-FLEX8-0575	0.05	0.14	0.31	0.60	1.07	1.65	2.29
B-FLEX12-0575	0.06	0.18	0.41	0.80	1.42	2.20	3.05

SUPER BLUE FLEX FITTINGS



FFP-T

FFP-75EM

FFP-50EM

FFP-C

SUPER BLUE FLEX FITTINGS

Model	Description
B-FLEX8-05	8" x 1/2" male x 1/2" street ell
B-FLEX12-05	12" x 1/2" male x 1/2" street ell
B-FLEX8-0575	8" x 1/2" male x 3/4" street ell
B-FLEX12-0575	12" x 1/2" male x 3/4" street ell
FFP-T	1/2" barbed tee
FFP-75EM	3/4" male x 1/2" barb elbow
FFP-50EM	1/2" male x 1/2" barb elbow
FFP-C	1/2" barbed coupler

Used with Super Blue Flex® pipe for installation of spray head risers. Ideal for use in high-traffic areas.



PRECISION™ CHECK VALVE



FEATURES & BENEFITS

Hold Back Strength of Up to 15 Feet

Capable of compensating for elevation changes in a zone of up to 15 feet, the Precision™ Check Valve (PCV) eliminates issues with low head drainage and the resulting water waste.

Spring-Actuated Design

Spring actuation ensures an immediate check when the irrigation cycle ends.

Low Profile

With an overall profile of just under 1 1/4" cubic inches, the PCV-500 adds less than 3/8" of height to retrofitted spray heads and can be retrofit to side inlet spray heads with minimal digging. The low profile design makes the PCV-500 ideal for turf or slope applications.

A Universal Fit

Featuring 1/2" NPT threads, the PCV fits all major manufacturers' spray bodies and fittings.



PRECISION™ CHECK VALVE MODEL LIST

Model	Description
PCV-500	15' Check Valve, 1/2" NPT

PCV-500 PRESSURE LOSS DATA

Flow Rate (gpm)	1	2	3	4	5
Pressure Loss (psi)	5.1	6.0	6.5	7.0	10.2

Note: Use of the PCV-500 is not recommended for irrigation systems with dynamic operating pressure of less than 35 psi.



Specifying Information—Precision™ Check Valve

PCV-XXX	
Model	Thread Size
PCV	XXX
PCV—Precision™ Check Valve	500—1/2" NPT, MxF

SPRAY TOOLS & ACCESSORIES

EFFLUENT WATER INDICATORS



- 570S**
(Nozzle not included)
- 570 Series shrub adapter
 - Installs onto a 1/2" NPT riser



- 570S-E**
(Nozzle not included)
- Lavender molded 570S Series shrub adapter
 - Installs onto a 1/2" NPT riser



- 89-9752**
- Lavender snap-on cover for use on 570Z Series pop-up models



- 102-1211**
- Lavender molded cap for use on 570Z Series pop-up models
 - Includes wiper seal



- I-PRO-NPC**
(Recycled-Water Cap)
- Threads onto all Irritrol® I-PRO Series spray head bodies and Rain Bird®* 1800* Series bodies
 - UV-resistant
 - Heavy-duty ABS material

ACCESSORIES



- 995-01**
- Flow gauge

SERVICEABLE PARTS



- 570SEAL**
- Serviceable seal for all 570Z models
 - Recommended for upgrades



- Check Valve 570CV**
- Check valve for all the 570Z models
 - Install in field to prevent low head drainage
 - 10' hold back



- I-PRO-CV (I-Pro Check Valve)**
- For use in Irritrol® I-Pro series spray head
 - Ideal solution for protection against low-head drainage
 - Reduce water waste and erosion

SHRUB ADAPTER



- HS100 (Shrub Adapter)**
- Threads directly onto riser
 - UV-treated
 - Heavy-duty ABS
 - Accepts all Irritrol® and any other female-threaded nozzle

TOOLS

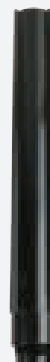

- 570-6X**
(35-2636)
- 570Z Extender
 - Male-inlet threads install onto any 570Z pop-up sprinkler or shrub adapter to provide a 6" extension
 - Maximum pressure: 75 psi
 - Not for use on XF/PRX models



- 570SR-6**
(35-2631) and **570SR-18**
- 570Z stationary riser
 - 1/2" male-threaded inlet for installation on pipe fittings
 - Maximum pressure: 75 psi
 - Height: 6", 18"

TOOLS



- PNOZZTOOL**
- Riser pull up tool
 - Fits all 570Z Sprays

ROTORs



Irritrol®



ROTORS

Pages 100-123

RESIDENTIAL

T5 RapidSet® Series Rotors	102-103
MINI 8 Series Rotors	104-105
300 Series Multi-Stream Rotor®	106-107
Titan™ Impact Rotor	108-109

COMMERCIAL

T7 Series Rotors	110-111
640 Series Rotors	112-113
TS90 Series Rotors	114-115

LARGE-AREA

TS170 Series Rotors	116-117
TS120 Series Impact Sprinklers	118-119
P2 Series Sprinklers	120-121
Roll CarT™ Traveling Sprinkler	122-123



T5 RAPIDSET® SERIES ROTORS



FEATURES & BENEFITS

RapidSet® Arc Adjustment (Available on RapidSet models only)

Arc adjustments from 40° to 360° can be made quickly with a few twists of the turret – no tools required. The RapidSet slip clutch also protects against gear damage caused by intentional vandalism or inexperienced users.

Lawn Model with a 5" Pop-up Height

Fits in the same footprint as many competing 4" rotors for hassle-free retrofits, but delivers an extra inch of pop-up height, allowing the nozzle to clear tall grasses.

Airfoil Technology™ Nozzles

The T5 Series rotor comes with a full set of 8 standard nozzles (25° trajectory) and 4 low angle (10° trajectory) nozzles that utilize proprietary Airfoil Technology, which creates a zone of low pressure just below the main stream to gently guide water downward for unmatched uniformity without forcefully washing out newly-laid seeds.

Design Flexibility

T5 RapidSet rotors are available in Effluent, Shrub, 12" High Pop and Stainless Steel models.



**Based on independently tested performance profiles from the Center for Irrigation Technology*

Stainless Steel Model Features

- ✓ 304 Stainless Steel riser and nozzle base protection
- ✓ Ideal for settings with heavy foot traffic or sandy soil conditions
- ✓ Heavy-duty construction protects the rotor from damage caused by vandalism



Effluent Options Available



Check Valve Options Available

SPECIFICATIONS

Operational

- Radius: 25 - 50 feet
- Flow rate: 0.74 - 9.70 gpm
- Arc: 40° to 360°, adjustable
- Inlet: 3/4" NPT
- Operating pressure range: 25-65 psi
- Recommended operating pressure: 45 psi
- Trajectory: 25° standard, 10° low angle
- Pop-up height: 5" (measured from top of cap to nozzle high-pop height opening)
- Available with factory-installed 1.5, 2.0, 2.5, or 3.0 gpm nozzle, or with no nozzle installed.

Dimensions

- Body Diameter:
- Lawn Pop-up: 2 1/4"
 - Shrub: 2 1/4"
 - High Pop: 2 1/4"
- Cap Diameter:
- Lawn Pop-up: 2 5/8"
 - Shrub: N/A
 - High Pop: 2 5/8"
- Height:
- Lawn Pop-up: 7 1/2"
 - Shrub: 7 3/4"
 - High Pop: 16 7/8"

Warranty

- Five years



LOW ANGLE NOZZLE PERFORMANCE DATA

Nozzle	psi	Radius	gpm	Precipitation Rate (in/hr) ▲ (in/hr) ■	
1.0LA	25	25	0.74	0.26	0.23
	35	28	0.94	0.27	0.23
	*45	28	1.02	0.29	0.25
	55	29	1.14	0.30	0.26
	65	29	1.25	0.33	0.29
1.5LA	25	27	1.10	0.34	0.29
	35	30	1.35	0.33	0.29
	*45	31	1.52	0.35	0.30
	55	31	1.75	0.40	0.35
	65	31	1.90	0.44	0.38
2.0LA	25	29	1.40	0.37	0.32
	35	31	1.72	0.40	0.34
	*45	32	2.05	0.45	0.39
	55	33	2.25	0.46	0.40
	65	33	2.45	0.50	0.43
3.0LA	25	29	2.20	0.58	0.50
	35	33	2.60	0.53	0.46
	*45	34	3.05	0.59	0.51
	55	36	3.40	0.58	0.51
	65	36	3.70	0.63	0.55

*Recommended operating pressure. Data based on 180°.

T5 RAPIDSET NOZZLE PERFORMANCE DATA

Nozzle	psi	Radius	gpm	Precipitation Rate (in/hr) ▲ (in/hr) ■	
1.5	25	33	1.15	0.23	0.20
	35	34	1.38	0.27	0.23
	*45	35	1.59	0.29	0.25
	55	35	1.74	0.32	0.27
	65	36	1.88	0.32	0.28
2.0	25	35	1.45	0.26	0.23
	35	36	1.80	0.31	0.27
	*45	37	2.12	0.34	0.30
	55	37	2.30	0.37	0.32
	65	37	2.58	0.42	0.36
2.5	25	35	1.75	0.32	0.28
	35	36	2.20	0.38	0.33
	*45	37	2.55	0.41	0.36
	55	37	2.80	0.45	0.39
	65	37	3.05	0.50	0.43
3.0 Standard	25	36	2.20	0.38	0.33
	35	38	2.60	0.40	0.35
	*45	40	3.05	0.42	0.37
	55	40	3.52	0.49	0.42
	65	40	3.80	0.53	0.46
4.0	25	37	2.95	0.48	0.41
	35	40	3.55	0.49	0.43
	*45	42	4.10	0.52	0.45
	55	42	4.45	0.56	0.49
	65	43	4.85	0.58	0.50
5.0	25	39	3.75	0.55	0.47
	35	41	4.50	0.60	0.52
	*45	43	5.10	0.61	0.53
	55	45	5.75	0.63	0.55
	65	45	6.10	0.67	0.58
6.0	25	39	4.20	0.61	0.53
	35	43	5.20	0.63	0.54
	*45	46	6.05	0.64	0.55
	55	47	6.65	0.67	0.58
	65	48	7.25	0.70	0.61
8.0	25	36	5.75	0.99	0.85
	35	43	7.10	0.85	0.74
	*45	47	8.05	0.81	0.70
	55	48	8.95	0.86	0.75
	65	50	9.70	0.86	0.75

*Recommended operating pressure. Data based on 180°.

T5 RAPIDSET® ROTOR MODEL LIST

Model	Description
T5P-RS-LN	5" RapidSet Lawn pop-up
T5PE-RS-LN	5" RapidSet Lawn pop-up, Effluent
T5PCK1.5-RS	5" RapidSet Lawn pop-up with Check Valve, 1.5 gpm nozzle
T5PCK2.0-RS	5" RapidSet Lawn pop-up with Check Valve, 2.0 gpm nozzle
T5PCK2.5-RS	5" RapidSet Lawn pop-up with Check Valve, 2.5 gpm nozzle
T5PCK3.0-RS	5" RapidSet Lawn pop-up with Check Valve
T5HP-RS	12" RapidSet High Pop
T5HPE-RS	12" RapidSet High Pop, Effluent
T5S-RS	RapidSet Shrub
T5SE-RS	RapidSet Shrub, Effluent
T5PSS3.0-RS	5" RapidSet Stainless Steel Lawn pop-up, 3.0 gpm nozzle
T5PSSE3.0-RS	5" RapidSet Stainless Steel Lawn pop-up, Effluent, 3.0 gpm nozzle
T5PCKSS3.0-RS	5" RapidSet Stainless Steel Lawn pop-up with Check Valve, 3.0 gpm nozzle

Specifying Information — T5 Series Rotors

T5XX XX XX X.X E-RS							
Base Model	Body	Optional	Optional	Custom Nozzles	Optional	Optional	Optional
T5	XX	XX	XX	X.X	E	-RS	-LN
T5— T5 Series Rotor	P - Lawn S - Shrub HP - High Pop	CK — Check Valve	SS — Stainless Steel Riser	1.5-1.5 gpm 2.0-2.0 gpm 2.5-2.5 gpm 3.0-3.0 gpm	E — Effluent	RS — RapidSet	LN — Less Nozzle
Example: A T5 Series Rotor Lawn Pop-up sprinkler with a 2.5 gpm nozzle and Check Valve would be specified as: T5PCK2.5-RS							



MINI 8 SERIES ROTORS

FEATURES & BENEFITS

Top-of-Rotor Arc Adjustment

Allows easy arc setting with a slotted screwdriver and features a quick reference dial for fast and accurate adjustments (40° to 360°).

Pressure-Activated Riser Seal

Helps prevent debris intrusion into the rotor's body and, ultimately, the system's water lines.

Ratcheting Riser

Allows the riser and fixed left edge to quickly be turned to the desired position without having to re-orient the entire rotor.

Five Interchangeable Nozzles

To cover varying flow and radius requirements.

Part and Full Circle In One

Offers more flexibility on new system installs and reduces inventory requirements.

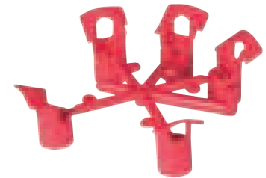

Nozzle Tree
Five interchangeable nozzles – comes pre-installed with a 1.5 nozzle



Check Valve
Optional for field installations



Check Valve
Options Available

PRODUCT HIGHLIGHT

Arc Setting

Visual arc setting dial within rubber cover allows for fast and easy arc adjustments.



Dry pull-up slot

Infinite arc adjustment from 45° to 360°

Nozzle retainer screw and stream diffuser

Not Too Big and Not Too Small – the Mini 8 is Just Right

The Mini 8 nozzles are designed for the efficient watering of smaller spaces, which means water savings when compared to full-size rotors. When compared to fixed sprays, the flexibility of the Mini 8 reduces the number of heads required, which in turn reduces the number of valves and stations needed. In either scenario, the Mini 8 brings together money savings and better water management.

MINI 8 SERIES MODEL LIST

Model	Description
MINI8-4P	Mini 8 Rotor, 4" Lawn Pop-up

SPECIFICATIONS

Operational

- Radius: 20'–35'
- Arc Adjustment – 40° to 360°
- Operating pressure range: 30-60 psi
- Flow Rate: 0.80 – 3.40 gpm
- Trajectory: 25°

Dimensions

- Body height: 6"
- Pop-up to nozzle height: 3¾"
- Exposed diameter: 1¾"
- Cap diameter: 2¼"
- Inlet: ½" female-thread

Options Available

- 102-2024 – Adjustment Tool
- MINI8-CV – Check Valve

Warranty

- Two years

MINI 8 SERIES PERFORMANCE DATA

Nozzle	psi	gpm	Radius (ft.)	Precipitation Rate (in./hour)	
				▲	■
.75	30	0.8	20	0.42	0.36
	40	0.9	21	0.44	0.38
	50	1.0	22	0.46	0.40
1.0	30	1.0	26	0.30	0.26
	40	1.1	27	0.34	0.30
	50	1.3	28	0.36	0.32
1.5*	30	1.3	29	0.24	0.30
	40	1.5	30	0.38	0.32
	50	1.7	31	0.40	0.34
2.0	30	1.7	30	0.42	0.36
	40	2.0	31	0.46	0.40
	50	2.3	31	0.54	0.46
3.0	30	2.6	34	0.50	0.44
	40	3.0	35	0.54	0.48
	50	3.4	35	0.62	0.54

Radius shown in feet. Data based on 180.

▲ Precipitation rates are for triangular spacing, shown in inches per hour, calculated at 50% of diameter.

■ Precipitation rates are for square spacing, shown in inches per hour, calculated at 50% of diameter.

All performance specifications are based on the stated working pressure available at the base of the sprinkler.

*Pre-installed nozzle.

Specifying Information—Mini 8 Series Rotors

MINI8-4P	
Description	Body
MINI8	4P
MINI8—Mini 8 Rotor	4P—Lawn Pop-up
Example: A Mini 8 Series sprinkler with a 3.0 nozzle, would be specified as: MINI8-4P-30	



300 SERIES MULTI-STREAM ROTOR®

FEATURES & BENEFITS

Unique Multiple Rotating Streams

Provides slow, effective watering, and the ability to couple different arcs on the same zone, which saves time and water.

Matched Precipitation Rate Arc Discs

Ensures uniform delivery of water across each square foot of an irrigated area, resulting in high-precision water application.

Choice of Six Nozzles and Nine Interchangeable Arc Discs

For maximum versatility covering varying landscape needs.



Effluent Options Available



300 Series arc discs come in nine different selections



Specifying Information— 300 Series Multi-Stream Rotor

3XX-XX-XX-E			
Arc	Body	Nozzle	Optional
3XX	XX	XX	E
04—90°	00—Lawn	01/21—Small Radius, 12 Ports	E—Effluent
05—112°	Pop-up	02/22—Medium Radius, 12 Ports	
06—135°	10—Shrub	03/23—Large Radius, 12 Ports	
07—157.5°	12—High Pop	15—Adjustable Shrub & Lawn Pop-up	
08—180°		25—Adjustable, High Pop-up	
09—202.5°		63—Large Radius, 6 Ports, Low gpm*	
10—225°		93—Large Radius, 9 Ports, Low gpm*	
12—270°			
16—360°			

Example: A 300 Series Shrub Sprinkler with a 90° arc and an adjustable nozzle, would be specified as: **304-10-15**

* Available on Lawn Pop-up and Shrub only.

PRODUCT HIGHLIGHT

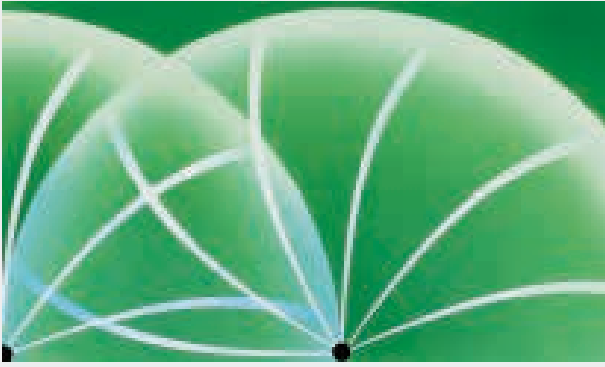

A Winning Combination of Watering Efficiency and Visual Appeal

The exclusive "fingers of water" application takes a flow of water and divides it into smaller streams at different trajectories for a stronger performance all across the landscape. Shorter radii get the coverage needed with enough water still in the main stream to reach longer distances. This also creates a heavier watering stream at the tail end of the spray allowing for greater wind resistance.

SPECIFICATIONS

Operational

- Radius: 14'-33'
- Flow Rate:
 - Lawn Pop-up and High-Pop: 0.57-7.51 gpm
 - Shrub (COM): 2.07-6.36 gpm
- Operating Pressure Range: 35-50 psi
- Pop-up Height to Nozzle:
 - Lawn Pop-up: 2³/₄"
 - High Pop: 11³/₄"
- Inlet (Female-threaded):
 - Lawn Pop-up and High-Pop: 3/4"
 - Shrub: Combined 1/2" to 3/4"
- Large basket filter screen

Dimensions

- Body Diameter: 2³/₈"
- Cap Diameter: 3"
- Height:
 - Lawn Pop-up: 6¹/₈"
 - High Pop: 16"
- Shrub Base Diameter: 1³/₄"

Options Available

Recycled Water Indicators:

- Lavender Cover, High-Pop (89-7854 - fits 300-25 Omni only)
- Lavender Cover, Lawn & Shrub (89-7853 - fits 300-15 Omni only)
- Lavender Cap, Standard Nozzles (89-7889 - fits 01, 02, 03, 63, 93)

Warranty

- Two years

300 SERIES: 300-15 (LAWN) AND 300-25 (HIGH POP) OMNI PERFORMANCE CHART

psi	Radius	Precipitation Rate*		gpm										
		▲	■	90°	112°	135°	157.7°	180°	202.5°	225°	270°	360°		
35	15	1.69	1.46	0.85	1.06	1.28	1.49	1.70	1.91	2.13	2.55	3.41		
35	18	1.37	1.19	1.00	1.24	1.50	1.75	2.00	2.25	2.50	3.00	4.00		
35	21	1.15	1.00	1.15	1.42	1.72	2.01	2.29	2.58	2.86	3.44	4.58		
35	24	0.99	0.86	1.29	1.60	1.94	2.26	2.58	2.91	3.23	3.88	5.17		
35	26	0.95	0.82	1.44	1.79	2.16	2.52	2.88	3.24	3.60	4.32	5.76		
50	18	1.60	1.38	1.16	1.44	1.74	2.04	2.33	2.62	2.91	3.49	4.65		
50	21	1.35	1.17	1.34	1.66	2.01	2.35	2.68	3.02	3.35	4.02	5.36		
50	24	1.17	1.02	1.52	1.88	2.28	2.66	3.04	3.42	3.80	4.56	6.08		
50	27	1.04	0.90	1.70	2.10	2.55	2.97	3.40	3.82	4.24	5.09	6.79		
50	30	0.93	0.80	1.88	2.33	2.82	3.29	3.75	4.23	4.69	5.63	7.51		

300 SERIES: FIXED RADIUS NOZZLE PERFORMANCE CHART

Nozzle	psi	Radius	Precipitation Rate*		gpm										
			▲	■	90°	112°	135°	157.7°	180°	202.5°	225°	270°	360°		
01/21	35	16	0.99	0.86	0.57	0.71	0.86	1.00	1.14	1.28	1.43	1.71	2.28		
	50	18	0.99	0.86	0.72	0.90	1.08	1.26	1.44	1.62	1.80	2.16	2.88		
02/22	35	21	0.73	0.63	0.72	0.90	1.08	1.26	1.44	1.62	1.80	2.16	2.88		
	50	24	0.66	0.57	0.85	1.06	1.28	1.49	1.71	1.92	2.13	2.56	3.41		
03/23	35	28	0.77	0.67	1.36	1.69	2.04	2.38	2.72	3.05	3.39	4.07	5.43		
	50	30	0.80	0.69	1.61	2.01	2.42	2.82	3.23	3.63	4.03	4.84	6.45		
63*	35	28	0.39	0.33	0.68	0.85	1.02	1.19	1.36	1.53	1.70	2.04	2.72		
	50	30	0.40	0.35	0.81	1.00	1.21	1.41	1.62	1.82	2.02	2.42	3.23		
93*	35	28	0.58	0.50	1.02	1.27	1.53	1.78	2.04	2.29	2.54	3.05	4.07		
	50	30	0.60	0.52	1.21	1.51	1.82	2.12	2.42	2.72	3.03	3.63	4.84		

*▲ Precipitation rates are for triangular spacing, shown in inches per hour, calculated at 50% of diameter.

■ Precipitation rates are for square spacing, shown in inches per hour, calculated at 50% of diameter.

All performance specifications are based on the stated working pressure available at the base of the sprinkler.

* Low gallonage. Radius shown in feet. Data based on 360°.

300 SERIES SHRUB (360° ARC DISC)

Nozzle	psi	300 Series gpm	Radius
01	50	2.07	14
01	75	2.95	16
02	50	2.48	23
02	75	3.69	25
03	50	4.55	27
03	75	6.24	29
63	50	2.66	28
63	75	3.82	30
93	50	3.64	29
93	75	5.29	31
Omni (Min)	50	2.67	16
Omni (Min)	75	3.95	18
Omni (Max)	50	5.08	30
Omni (Max)	75	6.36	33

300 SERIES LAWN POP-UP APEX @ 50 PSI

Nozzle	27°	
	Max. Ht. of Spray	
01	4' 10"	
02	5' 1"	
03	5' 11"	
63	7' 0"	
93	6' 3"	

300 SERIES MULTI-STREAM ROTOR MODEL LIST

Model	Description
300-00-00	Lawn Pop-up without Nozzle
300-10-00	Shrub without Nozzle
300-12-00	12" High Pop without Nozzle



TITAN™ IMPACT ROTOR

FEATURES & BENEFITS

Double-weighted Spray Guide Arm

Controls stream and prevents side splash onto buildings and walkways

Interchangeable, Color-coded MPR Nozzles

Pre-installed with black 3.0 gpm nozzle (no tools needed to change nozzles):

- 5 standard trajectory nozzles
- 2 low angle (LA) nozzles

Heavy-Duty, High Impact Case

With sturdy, reinforced ribbed design

Pressure-activated Wiper Seal

Assures reliable pop-up and pop-down

Radius Reduction Screw

Allows for up to 25% in-field radius reduction

Unique Lip Case Design

Aids in setting proper installation height, prevents grass and weeds from growing into head and minimizes backwash

Full- and Part-circle Operation

Offers convenience and reduces inventory requirements

Replaces Competitive Sprinklers

Simple upgrade for other impacts, including Rain Bird®* Maxi-Paw®*

Straight Flow-through Path

Ensures low pressure loss and positive action—even in very dirty water conditions

*Rain Bird® and Maxi-Paw® are trademarks of Rain Bird Corporation.



SPECIFICATIONS

Operational

- Full- & part-circle adjustable from 20° to 360°
- Radius: 32' - 45'
- Flow rate: 1.50–7.50 GPM
- Recommended operating pressure range: 30–50 psi
- Maximum operating pressure: 60 psi
- Recommended spacing: 22' to 45'
- Trajectory: 18°
- Combination ½" or ¾" female-threaded inlet

Dimensions

- Body diameter: 2½"–5"
- Cap diameter: 5"
- Height: 9 3/10"

Warranty

- Five years

TITAN SERIES PERFORMANCE DATA

Nozzle	psi	gpm	Radius (ft.)	Precipitation Rate (in./hour)	
				▲	■
1.5 (Orange)	30	1.5	32	0.14	0.16
	40	1.8	35	0.14	0.16
	50	2.3	36	0.17	0.20
2.0 (Red)	30	2.0	33	0.18	0.20
	40	2.2	37	0.15	0.18
	50	2.5	40	0.15	0.17
3.0 (Black)	30	2.9	35	0.23	0.26
	40	3.6	39	0.23	0.26
	50	5.0	41	0.23	0.26
4.0 (Blue)	30	3.8	38	0.25	0.29
	40	4.2	41	0.24	0.28
	50	5.1	42	0.28	0.32
6.0 (Green)	30	5.8	39	0.37	0.42
	40	6.5	43	0.34	0.39
	50	7.5	45	0.36	0.41

Radius shown in feet. Data based on 180.

▲ Precipitation rates are for triangular spacing, shown in inches per hour, calculated at 50% of diameter.

■ Precipitation rates are for square spacing, shown in inches per hour, calculated at 50% of diameter.

All performance specifications are based on the stated working pressure available at the base of the sprinkler.

*Pre-installed nozzle.

TITAN SERIES MODEL LIST

Model	Description
Titan	Impact Rotorz
Titan-NP	Impact Rotor - Non-Potable

Specifying Information—Titan Series Rotors

Titan-XX	
Description	Type
TITAN	X
Impact rotor	NP-Non Potable



T7 SERIES ROTORS



FEATURES & BENEFITS

Visual Arc Indication

Arc setting indicator on top of the rotor allows for easy wet or dry adjustments from 45°-360°.

High Efficiency Nozzles

Single port design ensures water is evenly distributed across the stream.

Vandal and Abuse Resistance

Smart Arc™ memory safely returns the sprinkler to previously set arc if vandalized. An integrated slip clutch prevents the breaking and stripping of gears.

Design Solutions and Safety

Standard Check-O-Matic Seal prevents low head drainage, and a minimal 2.2" exposed rubber cover diameter reduces the potential for injuries on play areas.

Durability

Heavy-duty retract spring and wiper seal reduce the occurrence of stick-ups and seal leakage, while a water-lubricated gear drive contributes to long-term consistent performance.



Effluent
Options
Available



SST Riser
Options
Available



Scan for more information
and additional Sports Fields
and Grounds products.

SPECIFICATIONS

Operational

- Radius capability:
 - Low flow models—39'-56'
 - Standard models—46'-75'
- Flow rates:
 - Low flow models—1.7-12.8 gpm
 - Standard models—6.6-30.6 gpm
- Operating pressure range: 40-100 psi
- Recommended operating pressure: 60-70 psi
- Inlet size: 1" female NPT
- Nozzle trajectory: 25°
- Arc adjustment: 45°-360° (unidirectional at 360°)

Dimensions

- Pop-up height (measured from top of cap to nozzle): 5"
- Body height: 8.8"
- Body diameter: 2.7"
- Rubber cover diameter: 2.2"

Available Options

- Stainless steel riser
- Effluent lavender rubber cover

Warranty

- Five years

STANDARD NOZZLES PERFORMANCE DATA

Nozzle	psi	Radius (ft)	gpm	Precip. Rate (in/hr) ▲	Precip. Rate (in/hr) ■
7.0	40	46	6.6	0.72	0.62
	50	47	7.4	0.75	0.65
	60	48	8.1	0.78	0.68
	70	49	8.8	0.82	0.71
	80	51	9.4	0.83	0.72
	90	52	10.3	0.85	0.73
	100	54	10.7	0.83	0.72
9.0	40	47	7.4	0.76	0.66
	50	50	8.3	0.73	0.64
	60	51	8.7	0.76	0.66
	70	52	9.4	0.81	0.70
	80	54	9.9	0.80	0.69
	90	55	10.9	0.82	0.71
	100	56	11.5	0.84	0.73
12.0*	40	50	9.5	0.89	0.77
	50	51	11.6	0.90	0.78
	60	53	12.7	0.91	0.79
	70	54	13.8	0.96	0.83
	80	55	14.7	0.99	0.86
	90	56	15.6	1.02	0.88
	100	57	16.5	1.04	0.90
16.0	40	53	13.0	1.06	0.92
	50	56	15.1	1.06	0.92
	60	58	16.2	1.04	0.90
	70	59	17.5	1.09	0.95
	80	61	18.8	1.10	0.95
	90	62	20.0	1.14	0.98
	100	63	21.1	1.17	1.01
20.0	40	53	16.0	1.28	1.10
	50	58	17.5	1.22	1.05
	60	60	19.5	1.21	1.05
	70	61	20.6	1.26	1.09
	80	65	22.2	1.19	1.03
	90	66	23.6	1.23	1.06
	100	67	24.8	1.25	1.09
24.0	40	52	15.8	1.27	1.10
	50	60	17.5	1.09	0.95
	60	63	19.3	1.11	0.96
	70	65	20.7	1.14	0.99
	80	67	22.3	1.15	1.00
	90	68	23.8	1.20	1.04
	100	71	25.3	1.16	1.01
27.0	40	55	18.7	1.42	1.23
	50	65	23.4	1.16	1.00
	60	71	23.6	1.05	0.91
	70	72	25.8	1.10	0.95
	80	73	27.4	1.14	0.99
	90	74	29.1	1.18	1.02
	100	75	30.6	1.21	1.05

LOW FLOW NOZZLES PERFORMANCE DATA

Nozzle	psi	Radius (ft)	gpm	Precip. Rate (in/hr) ▲	Precip. Rate (in/hr) ■
2.0	40	39	1.7	0.25	0.22
	50	39	2.0	0.29	0.25
	60	40	2.2	0.30	0.26
	70	40	2.4	0.33	0.28
	80	40	2.6	0.35	0.31
	90	41	2.7	0.36	0.31
	100	41	2.9	0.38	0.33
3.0*	40	39	2.4	0.36	0.31
	50	40	2.8	0.39	0.33
	60	41	3.1	0.41	0.36
	70	41	3.4	0.45	0.39
	80	42	3.6	0.46	0.40
	90	42	3.9	0.47	0.41
	100	43	4.1	0.49	0.42
4.5	40	38	4.1	0.63	0.54
	50	41	4.7	0.62	0.53
	60	41	5.2	0.68	0.59
	70	42	5.7	0.71	0.62
	80	42	6.1	0.77	0.66
	90	43	6.5	0.78	0.68
	100	43	6.9	0.83	0.72
6.0	40	43	5.0	0.59	0.51
	50	46	5.7	0.59	0.51
	60	48	6.3	0.61	0.52
	70	49	7.0	0.65	0.57
	80	49	7.4	0.68	0.59
	90	50	7.9	0.70	0.61
	100	50	8.4	0.74	0.64
7.5	40	44	5.8	0.66	0.58
	50	46	6.7	0.70	0.60
	60	48	7.4	0.71	0.62
	70	49	8.0	0.75	0.65
	80	50	8.8	0.78	0.67
	90	50	9.5	0.84	0.73
	100	52	10.0	0.81	0.70
9.0	40	45	7.4	0.81	0.70
	50	49	8.5	0.78	0.68
	60	51	9.4	0.80	0.70
	70	53	10.4	0.83	0.72
	80	55	11.3	0.83	0.72
	90	55	12.0	0.89	0.77
	100	56	12.8	0.90	0.78

* When the sprinkler is adjusted to 360°, it will be uni-directional in that direction of rotation (clockwise or counterclockwise) at the moment when the sprinkler was changed to 360°
 * Pre-installed nozzle. Data based on 180°.

Specifying Information—T7 Series Rotors

T7PXX-02XX			
Description	Optional	Thread	Optional
T7P	XX	02	XX
T7 Series Rotor	SS-Stainless Steel Riser	NPT Thread	E—Effluent L—Low Flow
Example: A low flow T7 Series rotor with a Stainless Steel riser and Effluent rubber cover would be specified as: T7PSS-02LE			

T7 ROTOR MODEL LIST

Model	Description
T7P-02	1" Rotor
T7P-02E	1" Rotor, Effluent rubber cover
T7P-02L	1" Rotor, Low Flow
T7P-02LE	1" Rotor, Low Flow, Effluent rubber cover
T7PSS-02	1" Stainless Steel Rotor
T7PSS-02E	1" Stainless Steel Rotor, Effluent rubber cover
T7PSS-02L	1" Stainless Steel Rotor, Low Flow
T7PSS-02LE	1" Stainless Steel Rotor, Low Flow, Effluent rubber cover



640 SERIES ROTORS

FEATURES & BENEFITS

Normally Open Valve-In-Head Body

Allows individual head control - the only commercial grade Toro rotor available with this feature.

Standard Check Valve

Prevents low head drainage and keeps laterals charged with water.



Effluent Options Available



Check Valve Options Available

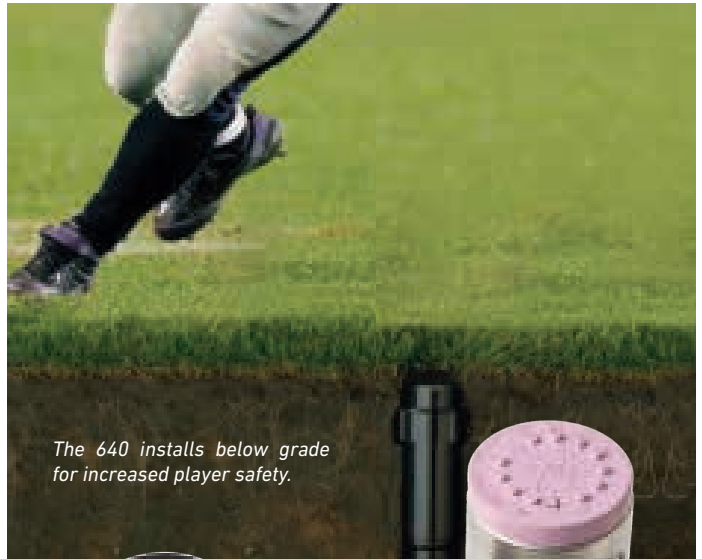

The 640 installs below grade for increased player safety.

640 SERIES MODEL LIST

Model	Description
ASSEMBLED ROTORS	
641-02-40	90°Arc with #40 Nozzle
641-02-41	90°Arc with #41 Nozzle
641-02-42	90°Arc with #42 Nozzle
641-02-43	90°Arc with #43 Nozzle
641-02-44	90°Arc with #44 Nozzle
642-02-40	180°Arc with #40 Nozzle
642-02-41	180°Arc with #41 Nozzle
642-02-42	180°Arc with #42 Nozzle
642-02-43	180°Arc with #43 Nozzle
642-02-44	180°Arc with #44 Nozzle
644-02-40	360°Arc with #40 Nozzle
644-02-41	360°Arc with #41 Nozzle
644-02-42	360°Arc with #42 Nozzle
644-02-43	360°Arc with #43 Nozzle
644-02-44	360°Arc with #44 Nozzle
BODY PACKAGE	
640-10	640 Body Package, VIH
640-20	Check-O-Matic 641 Body Package
DRIVE ASSEMBLY	
640-0045	640 Drive Assembly, 45 degrees
640-0060	640 Drive Assembly, 60 degrees
640-0090	640 Drive Assembly, 90 degrees
640-0108	640 Drive Assembly, 108 degrees
640-0127	640 Drive Assembly, 127 degrees
640-0148	640 Drive Assembly, 148 degrees
640-0173	640 Drive Assembly, 173 degrees
640-0180	640 Drive Assembly, 180 degrees
640-0192	640 Drive Assembly, 192 degrees
640-0238	640 Drive Assembly, 238 degrees
640-0270	640 Drive Assembly, 270 degrees
640-0360	640 Drive Assembly, 360 degrees
NOZZLE/STATOR SET	
640-40	#40 Nozzle and Stator
640-41	#41 Nozzle and Stator
640-42	#42 Nozzle and Stator
640-43	#43 Nozzle and Stator
640-44	#44 Nozzle and Stator



Scan for more information and additional Sports Fields and Grounds products.



Specifying Information—640 Series Rotors (Assembled Rotors)

64X-XX-XX				
Arc	Thread	Valve Type	Nozzle	Optional
64X	X	X	XX	E
0—Special Arc 1—90°	0—NPT Thread	1—Normally Open Valve-In-Head	41 - #41 Nozzle	E—Effluent Model
2—180°	5—BSP Thread	2—Check-O-Matic	42 - #42 Nozzle	
3—270°			43 - #43 Nozzle	
4—360°			44 - #44 Nozzle	

Example: A 640 Series Sprinkler with a 90° arc, 40 nozzle and a check valve, would be specified as: **641-02-40**

Most 640 sprinklers are available in component parts only. Consult Res/Com Finished Goods Price List for a complete list of sprinklers available as finished goods.

SPECIFICATIONS

Operational

- Radius: 47' – 67'
- Flow Rate: 6 – 25 gpm
- Operating Pressure Range: 40-90 psi
- Trajectory: 27°
- Pop-up to nozzle: 2³/₈"
- Inlet: 1" female-threaded
- Below-grade installation: up to 1/2"
- Check-O-Matic maintains up to 15' in elevation change
- Selection of five nozzles and 12 arcs
- Adjustment screw allows up to 25% radius reduction

Dimensions

- Body diameter: 2 1/2"
- Cap diameter: 3 1/4"
- Body height:
 - Check-O-Matic – 9"
 - Valve-In-head – 10 1/2"
- Exposed surface diameter when buried 1/2" below grade: 1 3/4"

Options Available

- Valve-In-Head Snap Ring Pliers (995-100)
- Valve Removal Tool (995-08)
- #41 Fast Rotating Stator (35-0579)

Warranty

- Five years

640 SERIES PERFORMANCE DATA

Nozzle	psi	gpm	Radius	360°		270°		238°		192°		180°		173°	
				▲	■	▲	■	▲	■	▲	■	▲	■	▲	■
40	40	6.0	47	0.30	0.26	0.40	0.35	0.46	0.39	0.57	0.49	0.60	0.52	0.63	0.54
	50	6.7	50	0.30	0.26	0.40	0.34	0.45	0.39	0.56	0.49	0.60	0.52	0.62	0.54
	60	7.3	52	0.30	0.26	0.40	0.35	0.45	0.39	0.56	0.49	0.60	0.52	0.62	0.54
	70	8.0	53	0.32	0.27	0.42	0.36	0.48	0.41	0.60	0.52	0.63	0.55	0.66	0.57
	80	8.6	54	0.33	0.28	0.44	0.38	0.50	0.43	0.62	0.53	0.66	0.57	0.68	0.59
90	9.2	55	0.34	0.29	0.45	0.39	0.51	0.44	0.64	0.55	0.68	0.59	0.70	0.61	
41	40	9.5	48	0.46	0.40	0.61	0.53	0.69	0.60	0.86	0.75	0.92	0.79	0.95	0.83
	50	10.2	53	0.40	0.35	0.54	0.47	0.61	0.58	0.76	0.60	0.81	0.70	0.84	0.73
	60	11.0	54	0.42	0.36	0.56	0.48	0.63	0.55	0.79	0.68	0.84	0.73	0.87	0.76
	70	11.9	55	0.44	0.38	0.58	0.50	0.66	0.57	0.82	0.71	0.87	0.76	0.91	0.79
	80	12.7	56	0.45	0.39	0.60	0.52	0.68	0.59	0.85	0.73	0.90	0.78	0.94	0.81
90	13.4	57	0.46	0.40	0.61	0.53	0.69	0.60	0.86	0.74	0.92	0.79	0.95	0.83	
42	40	12.0	52	0.49	0.43	0.66	0.57	0.75	0.65	0.93	0.80	0.99	0.85	1.03	0.89
	50	12.9	55	0.47	0.41	0.63	0.55	0.72	0.62	0.89	0.77	0.95	0.82	0.99	0.85
	60	14.0	56	0.50	0.43	0.66	0.57	0.75	0.65	0.93	0.81	0.99	0.86	1.03	0.89
	70	14.7	57	0.50	0.44	0.67	0.58	0.76	0.66	0.95	0.82	1.01	0.87	1.05	0.91
	80	15.8	58	0.52	0.45	0.69	0.60	0.79	0.68	0.98	0.85	1.04	0.90	1.09	0.94
90	16.8	58	0.56	0.48	0.74	0.64	0.84	0.73	1.04	0.90	1.11	0.96	1.16	1.00	
43	40	13.2	56	0.47	0.41	0.62	0.54	0.71	0.61	0.88	0.76	0.94	0.81	0.97	0.84
	50	14.5	59	0.46	0.40	0.62	0.53	0.70	0.61	0.87	0.75	0.93	0.80	0.96	0.83
	60	15.7	59	0.50	0.43	0.67	0.58	0.76	0.66	0.94	0.82	1.00	0.87	1.04	0.83
	70	17.0	61	0.51	0.44	0.68	0.59	0.77	0.67	0.96	0.83	1.02	0.88	1.06	0.92
	80	18.3	63	0.51	0.44	0.68	0.59	0.77	0.67	0.96	0.83	1.03	0.89	1.07	0.92
90	19.4	64	0.53	0.46	0.70	0.61	0.80	0.69	0.99	0.86	1.05	0.91	1.10	0.95	
44	40	16.7	55	0.61	0.53	0.82	0.71	0.93	0.80	1.15	1.00	1.23	1.06	1.28	1.11
	50	18.6	60	0.57	0.50	0.76	0.66	0.87	0.75	1.08	0.94	1.15	1.00	1.20	1.03
	60	19.9	61	0.59	0.52	0.79	0.68	0.90	0.78	1.12	0.97	1.19	1.03	1.24	1.07
	70	21.9	63	0.61	0.53	0.82	0.71	0.93	0.80	1.15	1.00	1.23	1.06	1.28	1.11
	80	23.4	65	0.62	0.53	0.82	0.71	0.93	0.81	1.16	1.00	1.23	1.07	1.28	1.11
90	25.0	67	0.62	0.54	0.82	0.71	0.94	0.81	1.16	1.01	1.24	1.07	1.29	1.12	
Nozzle	psi	gpm	Radius	148°		127°		108°		90°		60°		45°	
				▲	■	▲	■	▲	■	▲	■	▲	■	▲	■
40	40	6.0	47	0.73	0.64	0.85	0.74	1.01	0.87	1.21	1.05	1.81	1.57	2.42	2.09
	50	6.7	50	0.72	0.63	0.84	0.73	0.99	0.86	1.19	1.03	1.79	1.55	2.38	2.06
	60	7.3	52	0.73	0.63	0.85	0.74	1.00	0.75	1.20	1.04	1.80	1.56	2.40	2.08
	70	8.0	53	0.77	0.67	0.90	0.78	1.05	0.91	1.27	1.10	1.90	1.65	2.53	2.19
	80	8.6	54	0.80	0.69	0.93	0.80	1.09	0.95	1.31	1.14	1.97	1.70	2.62	2.27
90	9.2	55	0.82	0.71	0.96	0.83	1.13	0.98	1.35	1.17	2.03	1.76	2.71	2.34	
41	40	9.5	48	1.11	0.96	1.30	1.12	1.53	1.32	1.83	1.59	2.75	2.38	3.67	3.18
	50	10.2	53	0.98	0.85	1.14	0.99	1.34	1.16	1.62	1.40	2.42	2.10	3.23	2.80
	60	11.0	54	1.02	0.88	1.19	1.03	1.40	1.21	1.68	1.45	2.52	2.18	3.36	2.91
	70	11.9	55	1.06	0.92	1.24	1.07	1.46	1.26	1.75	1.52	2.62	2.27	3.50	3.03
	80	12.7	56	1.09	0.95	1.27	1.10	1.50	1.30	1.80	1.56	2.70	2.34	3.60	3.12
90	13.4	57	1.11	0.97	1.30	1.12	1.53	1.32	1.83	1.59	2.75	2.38	3.67	3.18	
42	40	12.0	52	1.20	1.04	1.40	1.21	1.64	1.42	1.97	1.71	2.96	2.56	3.95	3.42
	50	12.9	55	1.15	1.00	1.34	1.16	1.58	1.37	1.90	1.64	2.85	2.46	3.79	3.29
	60	14.0	56	1.21	1.05	1.40	1.22	1.65	1.43	1.99	1.72	2.98	2.58	3.97	3.44
	70	14.7	57	1.22	1.06	1.42	1.23	1.68	1.445	2.01	1.74	3.02	2.61	4.03	3.49
	80	15.8	58	1.27	1.10	1.48	1.28	1.74	1.51	2.09	1.81	3.13	2.71	4.18	3.62
90	16.8	58	1.35	1.17	1.57	1.36	1.85	1.60	2.22	1.92	3.33	2.89	4.44	3.85	
43	40	13.2	56	1.14	0.98	1.32	1.15	1.56	1.35	1.87	1.62	2.81	2.43	3.74	3.24
	50	14.5	59	1.13	0.97	1.31	1.14	1.54	1.34	1.85	1.60	2.78	2.41	3.71	3.21
	60	15.7	59	1.22	1.06	1.42	1.23	1.67	1.45	2.01	1.74	3.01	2.61	4.01	3.47
	70	17.0	61	1.23	1.07	1.44	1.25	1.69	1.47	2.03	1.76	3.05	2.64	4.06	3.52
	80	18.3	63	1.25	1.08	1.45	1.25	1.71	1.48	2.05	1.78	3.08	2.66	4.10	3.55
90	19.4	64	1.28	1.11	1.49	1.29	1.75	1.52	2.11	1.82	3.16	2.74	4.21	3.65	
44	40	16.7	55	1.49	1.29	1.74	1.50	2.04	1.77	2.46	2.13	3.68	3.19	4.91	4.25
	50	18.6	60	1.40	1.21	1.63	1.41	1.91	1.66	2.30	1.99	3.45	2.99	4.60	3.98
	60	19.9	61	1.45	1.25	1.68	1.46	1.98	1.71	2.38	2.06	3.57	3.09	4.76	4.12
	70	21.9	63	1.49	1.29	1.74	1.53	2.04	1.84	2.45	2.13	3.68	3.19	4.91	4.25
	80	23.4	65	1.50	1.30	1.74	1.51	2.05	1.78	2.46	2.13	3.70	3.20	4.93	4.27
90	25.0	67	1.50	1.30	1.75	1.52	2.06	1.79	2.48	2.15	3.72	3.22	4.95	4.29	

*▲ Precipitation rates are for triangular spacing, shown in inches per hour, calculated at 50% of diameter.

*■ Precipitation rates are for square spacing, shown in inches per hour, calculated at 50% of diameter.

All performance specifications are based on the stated working pressure available at the base of the sprinkler. Radius shown in feet. Note: For the 640, differing arcs cannot be valved together.



TS90 SERIES ROTORS

FEATURES & BENEFITS

TruJectory™ Adjustment from 7° to 30°

Fine tunes nozzle spray height, helps provide true head-to-head coverage, and compensates for windy conditions.

Part- and Full-Circle in One Sprinkler

No need to inventory multiple models or service parts

Back Nozzle Capable

Perfect for perimeter of sports fields. Provides the flexibility for fine-tuning any watering requirement.

Ratcheting Riser

Allows you to adjust the riser position in the body without disassembling. Simply pull up the riser and ratchet it to the precise position you want to water.

Three Nozzle Configuration

Provides better distribution uniformity, nozzle flexibility and system efficiency.

Constant-Velocity Drive

Provides reliable rotation speed – from sprinkler to sprinkler.

TurfCup™ for Sports Fields

The optional TurfCup version seamlessly integrates into either natural grass or artificial turf sports fields, enhancing player safety, surface playability and field aesthetics.



Effluent
Options
Available

Additional Features

- ✓ Full set of color-coded nozzles that thread directly into the nozzle port
- ✓ Rubber cover and below grade installation
- ✓ Check Valve standard – maintains up to 10' elevation
- ✓ Nozzle options: nine main, three intermediate, one inner

SPECIFICATIONS

Operational

- Radius: 53'-95' at 25° trajectory
- Flow Rate: 14.0-61.5 gpm
- Precipitation Rate: 0.6" per hour
- Arc: Full- and Part-circle in one
 - Full-circle: 360° unidirectional rotation
 - Part-circle: 40°-330°
- Rotation Speed: 3 minutes ± 30 seconds (360°)
- Inlet: 1" female-threaded (NPT)
- Operating pressure range: 40-100 psi

Dimensions

- Body Height: 10"
- Overall Height: 12 1/2"
- Retracted Height: 8 1/2"
- Pop-Up Height: 4"
- Exposed Cap Diameter: 2 1/4"

Warranty

- Five years

Options Available

- Nozzle, #9 Main (102-4259)
- Effluent Cap Marker (118-0063)
- Main Nozzle Tool (995-99)
- Intermediate nozzle and TruJectory™ tool (995-105)



TS90 SERIES MODEL LIST

Model	Description
TS90TP-02-14	#3 Main Nozzle and Yellow Stator pre-installed (includes #1, #2, and #4 Main nozzles)
TS90TP-02-58	#6 Main Nozzle and White Stator pre-installed (includes #5, #7, and #8 Main nozzles)
TS90TP-02TC	#8 Main Nozzle, White Stator, and TurfCup pre-installed (includes #5, #6, and #7 Main nozzles)

TS90TP NOZZLE PERFORMANCE DATA

Nozzle Set		Stator	50 psi		60 psi		70 psi		80 psi		90 psi		100 psi	
Number	Main/Intermediate		Radius (ft.)	Flow (gpm)	Radius (ft.)	Flow (gpm)	Radius (ft.)	Flow (gpm)	Radius (ft.)	Flow (gpm)	Radius (ft.)	Flow (gpm)	Radius (ft.)	Flow (gpm)
1	Yellow/Blue	102-1939 Yellow	53	14.0	54	15.2	55	16.4	55	17.4	54	18.5	56	19.4
2	Blue/Red		55	18.8	59	20.5	61	22.1	59	23.6	59	25.0	62	26.3
3	Brown/Orange		-	-	57	22.7	60	24.5	61	26.1	63	27.6	68	29.1
4	Orange/Orange		-	-	-	-	74	32.7	80	35.1	81	37.0	82	38.9
5	Green/Blue	102-1940 White	-	-	-	-	-	-	79	37.7	82	39.9	84	41.8
6	Gray/Blue		-	-	-	-	-	-	82	39.6	86	41.9	87	44.1
7	Black/Orange		-	-	-	-	-	-	80	43.6	87	46.2	84	48.6
8	Red/Blue		-	-	-	-	-	-	86	48.5	88	51.4	88	54.1
9	Beige/Blue	102-1941 White	-	-	-	-	-	-	85	55.1	91	58.3	95	61.6

Specifying Information—TS90 Series

TS90TP-02-XX			
Arc	Threads	Configuration	TurfCup™
TS90TP	02	X	TC
TS90TP— TS90TP 1" Rotor with TruJectory™	02—NPT	14—Yellow Stator 58—White Stator	TC—TurfCup option
Example: A TS90 Series sprinkler with TruJectory, NPT threads, and with an 82' radius would be specified as: TS90TP-02-58			



TS170 SERIES ROTORS

FEATURES & BENEFITS

Innovative Nozzle Technology

The unique nozzle design minimizes water turbulence, which helps to maintain stream exit speed at the nozzle outlet, resulting in higher radii at reduced flows. Nozzles are available in 16, 20, and 24 mm sizes.

Low Maintenance Piston Drive

A fully enclosed piston drive system presents smooth, continuous rotation.

Integrated Valve-in-Head

Electric valve in head models feature ON/OFF/Auto control at the rotor, and provide individual management of each rotor to help ensure they perform at their highest level of efficiency.

Reduced Watering Time

High flow capability of up to 303 gallons per minute, in combination with adjustable rotation speed allows a synthetic turf field featuring a system of TS170 Series Rotors to be wet down in under ten minutes.



Additional Features

- ✓ Completely Top-Serviceable
- ✓ Available with factory-installed Synthetic TurfCup™
- ✓ High-density body construction with stainless steel and brass components

SPECIFICATIONS

Operational

- Radius Capability: 111-177 feet
- Arc Adjustment: Part circle (30°-330°) / Full circle (360°)
- Output Flow: 113-303 gallons per minute
- Recommended Operating Pressure: 100 psi
- Maximum Operating Pressure: 145 psi
- Minimum Operating Pressure: 60 psi
- Nozzle Options: 16, 20 and 24 mm
- Nozzle Trajectory: 25°
- Speed of Rotation (180° arc): 50-120 seconds, adjustable (pressure dependent)
- Valve Type: Electric Valve-in-Head (VIH) 24V ac actuated solenoid

Dimensions

- Inlet Size: 2" NPT Female
- Overall Dimensions: 20.8" H x 13.75" W (Block Style model), 26.8" H x 13.75" W (VIH model)
- Cover Diameter: 10.1"
- Pop-up Height: 4.7"
- Overall Weight: 23 pounds (Block Style model), 26 pounds (VIH model)

Warranty

- Five years

TS170 SERIES MODEL LIST

Model	Description
TS170-02-16	TS170 Rotor, 16 MM, NPT
TS170-02-20	TS170 Rotor, 20 MM, NPT
TS170-02-24	TS170 Rotor, 24 MM, NPT
TS170V-02-16	TS170 Rotor with VIH, 16 MM, NPT
TS170V-02-20	TS170 Rotor with VIH, 20 MM, NPT
TS170V-02-24	TS170 Rotor with VIH, 24 MM, NPT
TS171-02-16	TS170 Rotor with Synthetic TurfCup, 16 MM, NPT
TS171-02-20	TS170 Rotor with Synthetic TurfCup, 20 MM, NPT
TS171-02-24	TS170 Rotor with Synthetic TurfCup, 24 MM, NPT
TS171V-02-16	TS170 Rotor with Synthetic TurfCup and VIH, 16 MM, NPT
TS171V-02-20	TS170 Rotor with Synthetic TurfCup and VIH, 20 MM, NPT
TS171V-02-24	TS170 Rotor with Synthetic TurfCup and VIH, 24 MM, NPT

TS170 PERFORMANCE DATA*

Pressure (psi)	16 mm Nozzle		20 mm Nozzle		24 mm Nozzle	
	Radius (ft)	Flow (gpm)	Radius (ft)	Flow (gpm)	Radius (ft)	Flow (gpm)
60	111	114	131	159	137	214
70	121	127	137	178	144	239
90	131	139	147	195	160	262
100	137	151	157	211	170	283
115	144	161	163	225	177	303

*Block style radius measurements at minimum rotation speed.

TS170 SERIES NOZZLES

Model	Description
RB25412	16 mm Nozzle
RB25413	20 mm Nozzle
RB25414	24 mm Nozzle

Specifying Information—TS170 Series Rotors

TS170-XX-XX		
Configuration	Inlet Thread	Nozzle
TS170	XX	XX
TS170 - TS170 long-range rotor	02 - 2" NPT	16 - 16 mm
TS170V - TS170 long-range rotor with VIH		20 - 20 mm
TS171 - TS170 long-range rotor with Synthetic TurfCup		24 - 24 mm
TS171V - TS170 long-range rotor with Synthetic TurfCup and VIH		

Example: A TS170 Rotor with 16 mm nozzle would be specified as: **TS170-02-16**



TS120 SERIES IMPACT SPRINKLERS

FEATURES & BENEFITS

Synthetic or Natural Turf applications

The TS120 Series Nozzles offer excellent water distribution and radius capability, giving the TS120 sprinkler the ability to meet the needs and expectations of groundskeepers of both Synthetic and natural Turf fields.

Flexibility and Ease of Use

A Full Circle rotation speed of 60 seconds and easy tool-free arc adjustments allow flexibility in field design and irrigation schedules to best meet the needs of the site. All sprinkler parts can be dismantled and serviced from the top, limiting the need for digging or sub-surface access.

Top Serviceable Valve-in-Head

Electric Valve-In-Head (VIH) models feature ON/OFF/Auto control at the top of the sprinkler and provide individual control of each sprinkler to help ensure optimal performance and ease of maintenance.

Durable and Versatile

With the ability to operate on reclaimed and grey water systems, the robust and heavy-duty design makes the TS120 insensitive to many environmental conditions, such as frost and sand.



Additional Features

- ✓ High level of wind resistance due to high velocity streams
- ✓ Full Circle models include a back nozzle for optimal coverage
- ✓ High-strength stainless steel riser helps prevent sprinkler damage due to unintended impact or vandalism
- ✓ Quick-release lid with steel-reinforced clip

SPECIFICATIONS

Operational

- Radius Capability: 62-125 feet
- Arc Adjustment: Part Circle (30°-330°)/Full Circle (360°)
- Output Flow: 20-121 gallons per minute
- Recommended Operating Pressure range: 45-120psi
- Maximum Operating Pressure: 145 psi
- Minimum Operating Pressure: 45 psi
- Nozzle Options: 7,8,9,10,11,12,13,14,15 and 17.5 mm
- Nozzle Trajectory: 22°
- Speed of Rotation (360°): 60 seconds
- Valve Type: Electric Valve-in-Head (VIH) 24V ac actuated solenoid

Dimensions

- Inlet Size: 1/2" NPT female
- Overall Dimensions:
 - 14.8" H x 10.1" W (Block Style model)
 - 17.9" H x 10.1" W (VIH model)
 - 26.0" H x 10.1" W (VIH with TurfCup models)
- Pop-up Height (measured from grade to top of lid):
 - 4" (Standard)
 - 8.1" (with TurfCup)

Standard Nozzles*

- TS120 – 17.5 mm
- TS121 – 15 mm
- TS122 – 15 mm

Warranty

- Five years

*Other nozzle sizes sold separately.

TS120 SERIES MODEL LIST

Model	Description
TS120P-02	TS120 Impact Sprinkler, Part Circle
TS120F-02	TS120 Impact Sprinkler, Full Circle
TS120VP-02	TS120 Impact Sprinkler with VIH, Part Circle
TS120VF-02	TS120 Impact Sprinkler with VIH, Full Circle
TS121VP-02	TS120 Impact Sprinkler with VIH and TurfCup™, Part Circle
TS121VF-02	TS120 Impact Sprinkler with VIH and TurfCup, Full Circle
TS122VP-02	TS120 Impact Sprinkler with VIH and Synthetic Turf Cover, Part Circle
TS122VF-02	TS120 Impact Sprinkler with VIH and Synthetic Turf Cover, Full Circle

TS120 SERIES NOZZLES

Model	Description
RT17463	7 mm Nozzle
RT17464	8 mm Nozzle
RT17465	9 mm Nozzle
RT17466	10 mm Nozzle
RT17467	11 mm Nozzle
RT17468	12 mm Nozzle
RT17469	13 mm Nozzle
RT17470	14 mm Nozzle
RT17471	15 mm Nozzle
RT17472	16 mm Nozzle
RT17473	17.5 mm Nozzle (Standard Nozzle)

TS120 SERIES NOZZLE PERFORMANCE DATA – PART CIRCLE MODELS

psi	7 mm Nozzle		8 mm Nozzle		9 mm Nozzle		10 mm Nozzle		11 mm Nozzle		12 mm Nozzle		13 mm Nozzle		14 mm Nozzle		15 mm Nozzle		17.5 mm Nozzle	
	Radius (ft)	Flow (gpm)	Radius (ft)	Flow (gpm)	Radius (ft)	Flow (gpm)	Radius (ft)	Flow (gpm)	Radius (ft)	Flow (gpm)	Radius (ft)	Flow (gpm)	Radius (ft)	Flow (gpm)	Radius (ft)	Flow (gpm)	Radius (ft)	Flow (gpm)	Radius (ft)	Flow (gpm)
40	62	20.3	64	25.1	65	30.0	67	34.8	69	38.8	70	44.1	72	49.3	74	55.9	75	62.1	79	74.9
60	64	22.9	67	28.6	69	34.4	72	39.6	75	44.9	79	50.7	82	56.8	85	64.3	88	71.8	92	86.3
70	68	25.6	71	31.7	73	39.3	76	44.1	81	49.8	87	56.4	90	63.4	95	71.8	98	79.7	102	96.0
90	70	28.2	74	34.8	77	41.9	81	48.5	87	54.6	92	61.7	95	69.2	100	78.4	105	87.2	111	104.4
100	72	30.0	76	37.4	81	44.9	86	52.0	91	58.6	96	66.5	100	74.4	105	84.6	110	94.3	120	113.7
115	73	32.2	79	40.1	84	48.0	90	55.5	95	62.6	101	70.9	105	83.3	110	90.3	115	100.9	125	121.1

TS120 SERIES NOZZLE PERFORMANCE DATA – FULL CIRCLE MODELS WITH BACK NOZZLE

psi	7 mm Nozzle		8 mm Nozzle		9 mm Nozzle		10 mm Nozzle		11 mm Nozzle		12 mm Nozzle		13 mm Nozzle		14 mm Nozzle		15 mm Nozzle		17.5 mm Nozzle	
	Radius (ft)	Flow (gpm)	Radius (ft)	Flow (gpm)	Radius (ft)	Flow (gpm)	Radius (ft)	Flow (gpm)	Radius (ft)	Flow (gpm)	Radius (ft)	Flow (gpm)	Radius (ft)	Flow (gpm)	Radius (ft)	Flow (gpm)	Radius (ft)	Flow (gpm)	Radius (ft)	Flow (gpm)
40	62	24.7	64	29.5	65	34.4	67	39.2	69	43.2	70	48.5	72	53.7	74	60.4	75	66.5	79	79.3
60	64	27.8	67	33.5	69	39.2	72	44.5	75	49.8	79	55.5	82	61.7	85	69.2	88	76.7	92	91.2
70	67	31.3	70	37.4	73	44.1	76	49.8	81	55.5	87	62.1	90	69.2	95	77.5	98	85.5	102	101.8
90	70	34.8	74	41.4	77	48.5	81	55.1	87	61.2	92	68.3	95	75.8	100	85.0	105	93.8	111	111.9
100	72	36.6	76	44.5	81	52.0	86	59.0	91	65.6	96	73.6	100	81.5	105	91.6	110	101.3	120	120.7
115	73	39.6	79	47.6	84	56.0	90	63.0	95	70.5	101	78.4	105	87.2	110	97.8	115	108.4	125	126.0

Specifying Information – TS120 Series Impact Sprinklers

TS12XXX-02			
Configuration	Style	Arc	Threads
TS12X	X	X	02
TS120 – TS120 long-range impact sprinkler TS121 – TS120 long-range impact sprinkler with TurfCup TS122 – TS120 long-range impact sprinkler with Synthetic Turf cover	Blank – Block Style V – Valve-In-Head	P – Part Circle F – Full Circle	02 – 1.5" NPT
Example: A full circle TS120 Series Impact Sprinkler with VIH, TurfCup would be specified as: TS121VF-02 (15 mm nozzle included)			



P2 SERIES SPRINKLERS

FEATURES & BENEFITS

Adjustable Rotation Speed

Easy-to-adjust rotation speed allows a complete rotation to be accomplished between two and seven minutes.

Low Maintenance Piston Drive

A fully enclosed piston drive system presents smooth, near vibration-free rotation, which helps to maintain the even distribution of water.

Wide Range of Nozzles

Nozzle choices from 14 mm to 34 mm provide a wide range of irrigation options and the flexibility to tailor the P2 Series to the specific needs of the site.

Part- and Full-Circle in One

Infinitely adjustable between 30° and 330°, or capable of uni-directional 360°.



P2M

P2S SERIES MODEL LIST

Model	Description
T-P2S	P2S High Volume Gun with 14 mm Nozzle
RT25150	14 mm Nozzle, P2S
RT25151	16 mm Nozzle, P2S
RT25152	18 mm Nozzle, P2S
RT25153	20 mm Nozzle, P2S
RT25154	22 mm Nozzle, P2S
RT25155	24 mm Nozzle, P2S

P2M SERIES MODEL LIST

Model	Description
T-P2M	P2M High Volume Gun with 26 mm Nozzle
RT24961	18 mm Nozzle, P2M
RT24962	20 mm Nozzle, P2M
RT24963	22 mm Nozzle, P2M
RT24964	24 mm Nozzle, P2M
RT24965	26 mm Nozzle, P2M
RT24966	28 mm Nozzle, P2M
RT24967	30 mm Nozzle, P2M
RT24968	32 mm Nozzle, P2M
RT24969	34 mm Nozzle, P2M

SPECIFICATIONS

Operational

- Radius Capability
 - P2S: 105-180 feet
 - P2M: 138-226 feet
- Output Flow
 - P2S: 70-267 gallons per minute
 - P2M: 131-535 gallons per minute
- Recommended Operating Pressure range:
 - P2S: 60-115 psi
 - P2M: 70-115 psi
- Maximum Operating Pressure: - 120 psi
- Minimum Operating Pressure: - 60 psi

- Nozzle Options:
 - P2S: 14, 16, 18, 20, 22, 24 mm
 - P2M: 18, 20, 22, 24, 26, 28, 30, 32, and 34 mm
- Nozzle Trajectory:
 - 25°
- Speed of Rotation:
 - Adjustable between 2-7 minutes
- Arc Adjustment:
 - Part circle (30°-330°) / Full circle (360°)

Warranty

- Five years

Dimensions

- Inlet Size
 - P2S: 2½" NPT female
 - P2M: 3" NPT female
- Overall Dimensions:
 - P2S: 15.2" H x 21.3" L
 - P2M: 17.4" H x 26.3" L
- Overall Weight:
 - P2S: 9.5 pounds
 - P2M: 10.8 pounds

P2S NOZZLE PERFORMANCE DATA

Pressure (psi)	14 mm Nozzle*		16 mm Nozzle		18 mm Nozzle		20 mm Nozzle		22 mm Nozzle		24 mm Nozzle	
	Radius (ft)	Flow (gpm)	Radius (ft)	Flow (gpm)	Radius (ft)	Flow (gpm)	Radius (ft)	Flow (gpm)	Radius (ft)	Flow (gpm)	Radius (ft)	Flow (gpm)
60	105	69.9	114	88.7	131	109.6	136	133.8	140	160.2	147	189.0
70	111	78.1	124	99.2	141	123.0	147	149.6	150	179.1	157	211.3
90	118	85.6	134	108.6	150	134.8	157	163.9	164	196.2	170	231.5
100	124	92.5	141	117.4	154	145.6	164	177.1	169	211.9	175	250.0
115	131	98.9	144	125.5	160	155.6	167	189.3	173	226.5	180	267.3

*Standard nozzle, 14 mm (other nozzles ordered separately).

P2M NOZZLE PERFORMANCE DATA

Pressure (psi)	18 mm Nozzle		20 mm Nozzle		22 mm Nozzle		24 mm Nozzle		26 mm Nozzle*		28 mm Nozzle		30 mm Nozzle		32 mm Nozzle		34 mm Nozzle	
	Radius (ft)	Flow (gpm)	Radius (ft)	Flow (gpm)	Radius (ft)	Flow (gpm)	Radius (ft)	Flow (gpm)	Radius (ft)	Flow (gpm)	Radius (ft)	Flow (gpm)	Radius (ft)	Flow (gpm)	Radius (ft)	Flow (gpm)	Radius (ft)	Flow (gpm)
70	138	130.8	144	157.2	151	186.8	157	218.9	164	254.2	174	292.1	180	332.6	187	376.2	190	422.5
90	148	143.2	154	172.2	161	204.8	167	240.1	174	278.4	184	319.8	190	364.3	197	411.9	200	463.0
100	157	154.6	164	186.3	170	221.1	177	259.0	187	300.4	197	345.4	207	393.4	213	444.9	216	499.6
115	164	165.2	170	199.1	177	236.1	184	277.1	193	321.1	203	369.2	213	420.7	220	475.8	226	534.6

*Standard nozzle, 14 mm (other nozzles ordered separately).

Specifying Information – P2 Series Sprinkler

T-P2X-X		
Configuration	Trajectory	Nozzle
T-P2X	X	XX
T-P2S – P2 Series High Volume gun-style sprinkler (2.5" NPT) T-P2M – P2 Series High Volume gun-style sprinkler (3" NPT)	Blank – 25°	14 – 14 mm 26 – 26 mm* 16 – 16 mm 28 – 28 mm* 18 – 18 mm 30 – 30 mm* 20 – 20 mm 32 – 32 mm* 22 – 22mm 34 – 34 mm* 24 – 24 mm

Example: A P2S Sprinkler would be specified as: **T-P2S**

* Nozzle sizes are only available for P2M models.



ROLLCART™ TRAVELING SPRINKLER

FEATURES & BENEFITS

Variable Speed

Adjustable travel speed allows the Rollcart to be dialed in to meet the specific needs of the turf.

Auto Shutoff

To eliminate water waste and over-watering, the Rollcart will stop irrigation and traveling once the guide cable has been fully retracted and the pass/cycle is complete.

Ease of Maintenance

Encased in a sealed gearbox, the drive gears have a very low friction factor and are practically maintenance free.

Flexible

A guide cable length of over 350 feet presents a wide range of applicable settings.

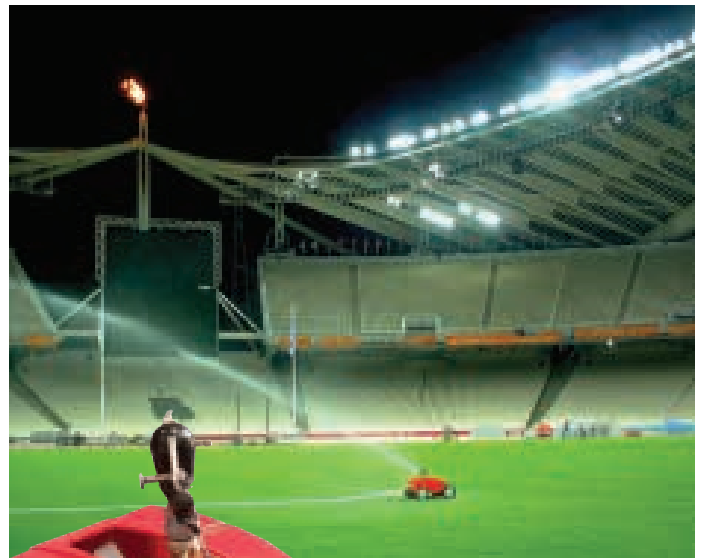

Additional Features

- ✓ 1" hose inlet
- ✓ High-density body construction with stainless steel and brass components
- ✓ Galvanized anchor stake

Specifying Information – Rollcart™

Rollcart Traveling Sprinkler	
Model	Description
T-ROLLCART	Rollcart Traveling Sprinkler

SPECIFICATIONS

Operational

- Radius capability: 52-64 feet
- Arc Adjustment: Part circle (30°-330°) / Full circle (360°)
- Output Flow: 11-20 gallons per minute
- Travel Speed: 20-70 feet per hour, adjustable
- Travel Distance: up to 390 feet
- Recommended Operating Pressure: 65 psi
- Maximum Operating Pressure: 100 psi
- Minimum Operating Pressure: 50 psi
- Nozzle Options: 6 and 7 mm

Dimensions

- Inlet Size: 1"
- Overall Dimensions: 30" long x 18" wide x 16" tall
- Overall Weight: 60 pounds

Warranty

- Two Years

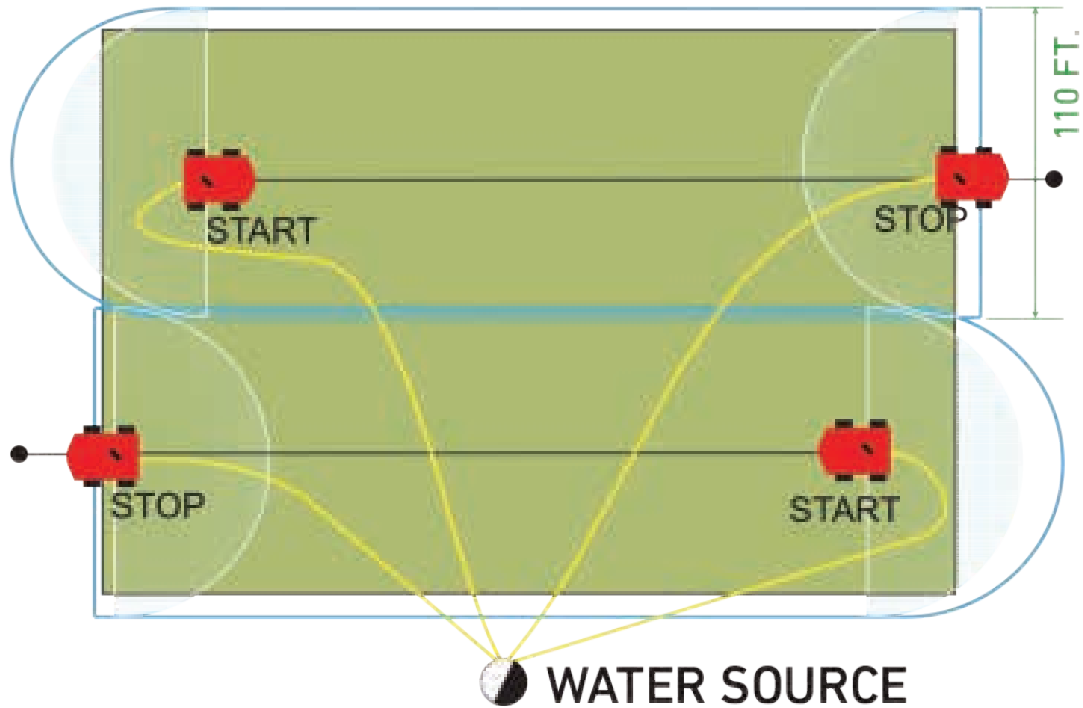

RollcarT™ Traveling Sprinkler

The autonomous RollcarT™ can operate in part-or full-circle mode and starts travelling along its integrated guide cable as soon as the water supply is turned on. The RollcarT will automatically stop and shut off the irrigation at the end of its run.

ROLLCART PERFORMANCE DATA

psi	6 mm Nozzle		7 mm Nozzle	
	Radius (ft)	Flow (gpm)	Radius (ft)	Flow (gpm)
60	52	11.3	56	15.4
70	55	12.6	59	18.0
90	58	13.8	61	19.6
100	60	14.9	64	20.3

LANDSCAPE DRIP





LANDSCAPE DRIP

Pages 124-143

DRIP LINE

DL2000™ Series Subsurface Dripline	126-127
17mm Drip In® Brown Surface Dripline	128-129
Blue Stripe® Polyethylene Hose	130-131
Tri-Loc™ Fittings	132
Drip Fittings and Accessories	133

EMMITERS

NGE® Emitters	134-135
Turbo-SC™ Plus Pressure-compensating Emitter	136
Varis™ and Varistake™ Adjustable Emitters	137
Pressure Regulating Multi-Outlet Drip Manifold	137
Spray to Drip Retro Fit Kit	138
E-2™ Classic Take Apart Emitter	139
Drip Bubblers	140

VALVES

Plastic Y Filters	141
Pressure Regulators	141
Drip Zone Valve Kits	142-143



DL2000™ SERIES SUBSURFACE DRIPLINE

FEATURES & BENEFITS

U.S. Government-Approved ROOTGUARD® Protection

Pre-emergent, ROOTGUARD® creates a “force field” around emitter outlet, diverting root growth and assuring long term reliability.

At Grade or Buried Options

Can be installed at grade or buried 4” – 8” underground, delivering irrigation directly to the plant’s root zone.

Environmentally Friendly

Irrigation takes place at or below grade so there is minimal water loss due to mist, evaporation, run-off or wind. Fertigation needs are reduced because water is applied only at the root zone.

Safety and Liability

When DL2000 is installed below ground, the landscape surface is free from irrigation equipment that may disrupt activities or cause injury. Sub-surface performance also avoids slippery walkways and roadways as well as wet walls, fences and windows.



Effluent
Options
Available

SPECIFICATIONS

Operational

- Design flexibility for narrow, odd-shaped landscape areas
- Precise watering puts water where it’s needed; avoids water marks on expensive hardscapes, glass or signage
- Distinctive red stripe on tubing signifies DL2000 with ROOTGUARD®

Warranty

- Against Root Intrusion: Seven years
- Hose: Five years pro-rated
- Emitters: Two years



DL2000 MODEL LIST

Model	Description
5/8" DL2000 PC DRIPLINE WITH ROOTGUARD®	
RGP-212-01	0.5 gph, 12" emitter spacing, 100 ft. coil
RGP-412-01	1.0 gph, 12" emitter spacing, 100 ft. coil
RGP-218-01	0.5 gph, 18" emitter spacing, 100 ft. coil
RGP-418-01	1.0 gph, 18" emitter spacing, 100 ft. coil
RGP-212-05	0.5 gph, 12" emitter spacing, 500 ft. coil
RGP-412-05	1.0 gph, 12" emitter spacing, 500 ft. coil
RGP-218-05	0.5 gph, 18" emitter spacing, 500 ft. coil
RGP-418-05	1.0 gph, 18" emitter spacing, 500 ft. coil
RGP-212-10	0.5 gph, 12" emitter spacing, 1000 ft. coil
RGP-412-10	1.0 gph, 12" emitter spacing, 1000 ft. coil
RGP-218-10	0.5 gph, 18" emitter spacing, 1000 ft. coil
RGP-418-10	1.0 gph, 18" emitter spacing, 1000 ft. coil
5/8" DL2000 PC PURPLE DRIPLINE WITH ROOTGUARD®	
RGP-212-05-E	0.5 gph, 12" emitter spacing, 500 ft. coil
RGP-412-05-E	1.0 gph, 12" emitter spacing, 500 ft. coil
RGP-218-05-E	0.5 gph, 18" emitter spacing, 500 ft. coil
RGP-418-05-E	1.0 gph, 18" emitter spacing, 500 ft. coil

Part No.	5/8" OD Flow Rate (gph)	Emitter Spacing	INLET PRESSURE VS. MAXIMUM LENGTH OF RUN IN FEET			
			15 psi	25 psi	30 psi	40 psi
RGP-212	.53	12"	250'	360'	400'	460'
RGP-218	.53	18"	350'	515'	565'	650'
RGP-412	1.0	12"	160'	240'	260'	300'
RGP-418	1.0	18"	240'	340'	375'	430'

HOW IT WORKS

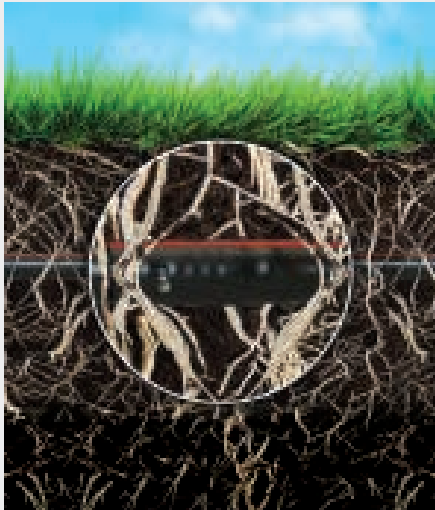

ROOTGUARD® creates a barrier to root intrusion around each emitter

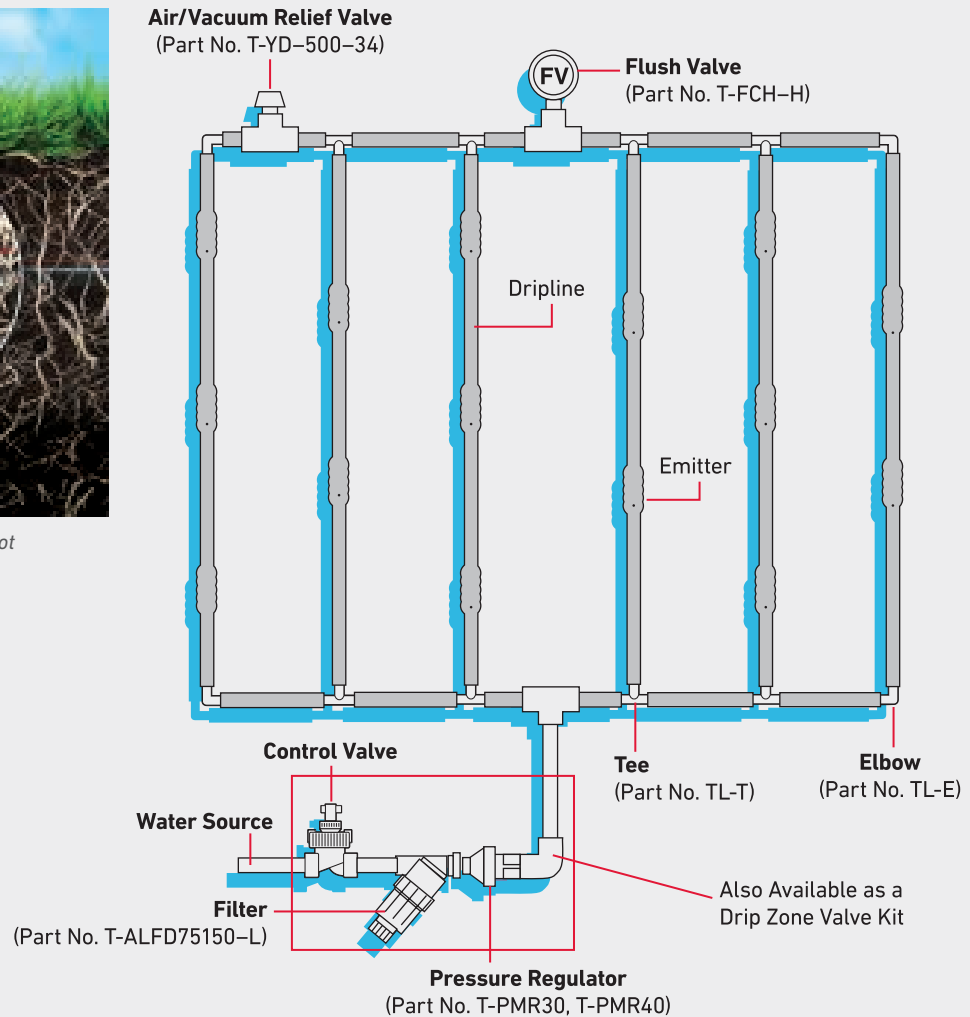

PRECIPITATION RATE FOR EVENLY SPACED LATERALS AND EMITTERS

Precipitation Rate for Drip Laterals (inches/hour)							
Emitter Flow (gph)	Emitter Spacing (in.)	Spacing Between Drip Laterals					
		6 in.	12 in.	18 in.	24 in.	30 in.	36 in.
0.53	12	1.7	0.85	0.57	0.43	0.34	0.28
0.53	18	1.13	0.57	0.38	0.28	0.23	0.19
1.00	12	3.27	1.64	1.09	0.82	0.65	0.55
1.00	18	2.18	1.09	0.73	0.55	0.44	0.36

Precipitation Rate Formula:
 Precipitation Rate (in./hr.) = $\frac{231.1 \times \text{Emitter Flow (gph)}}{\text{Lateral Spacing (in.)} \times \text{Emitter Spacing (in.)}}$

Note: This formula applies to evenly spaced drip irrigation laterals and emitters.

DL2000 PERFORMANCE TABLE

Flow Rate	.53/1.00 gph
Inside Diameter	0.620"
Outside Diameter	0.710"
Wall	0.045"
Operating pressure (P)	15-60 psi
Minimum filtration requirement	120 Mesh

Specifying Information—DL2000

RGP X-XX-XX-E			
Emitter Flow	Emitter Spacing	Coil Length	Optional
X	XX	XX	E
2—.53 gph 4—1.0 gph	12—12" 18—18"	01—100' 05—500' 10—1000'	E—Purple Tubing for Non-potable Water

Example: A 500' coil of Pressure-compensating Dripline with ROOTGUARD®, 12" emitter spacing and 0.5 gph, would be specified as: **RGP-212-05**

Note: Specify/use Tri-Loc(TM) Fittings, Toro i620 Series barbed fittings, or .710 Compression Fittings.



17MM DRIP IN® BROWN SURFACE DRIPLINE

FEATURES & BENEFITS

Universal 17MM Size

Works with most standard-size barb fittings, making it compatible with most dripline and hose for easy retrofits and expansions.

Fully Pressure-compensating from 15 – 60 psi

The pressure-compensating design makes it ideal for slopes, high wind areas and areas with limited water supply or low pressure.

High Uniformity

Proven, dependable pressure-compensating Drip In emitters deliver uniform, precise emitter discharge rates with exceptionally low variability.

Keeps Water Off Hardscapes

Preventing unsightly water stains.



PRODUCT HIGHLIGHT

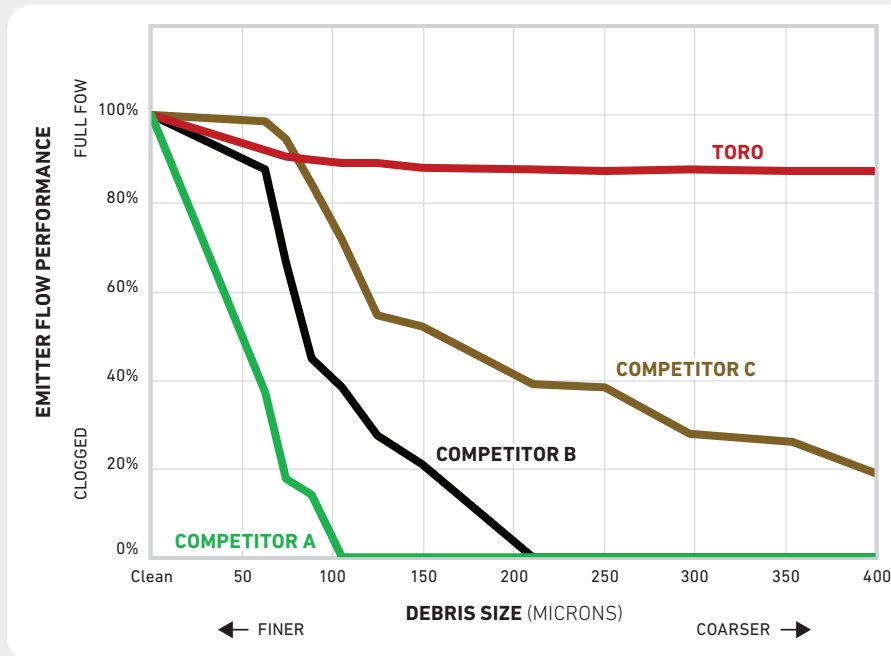

All Toro® landscape dripline uses a large double-outlet cylindrical emitter, which is much more tolerant of debris compared to the other market leaders, most of whom use a compact single-outlet emitter. While filtration is always recommended for any drip irrigation installation, filters only protect the incoming water from the valve connection. In the event of a damaged line at any point from the filter on down, or any other possible point of entry into the system for debris, Toro outperforms the competition and consistently keeps on flowing.

*Test data collected in Toro's standardized 24-hour "grit test", used for qualifying all Toro low-flow Landscape and Agriculture products in an internal test lab.

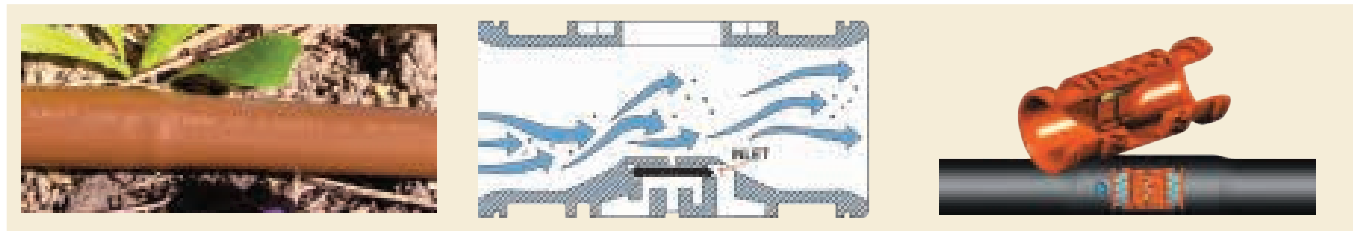

New Laser Etching

Easy-to-identify product information right on the tubing, and holds up better over time in the field compared to inkjet printing.

Highly Clog Resistant

Unique, raised internal filtration design deflects debris upward and away from the emitter's inlet. Because the inlet is also raised, sediment won't collect at the inlet while the system is off.

Dual Opposed Outlets

In above ground installations, dual opposing ports in every emitter assure that at least one outlet provides air relief, which prevents back-siphonage of contamination into the emitter.

DRIP IN PC MODEL LIST

Model	Description
17MM BROWN PC DRIPLINE – 0.56" ID X 0.66" OD X 0.05" WALL	
PCB-212-010	0.58 gph, 12" emitter spacing, 100' coil
PCB-412-010	0.92 gph, 12" emitter spacing, 100' coil
PCB-218-010	0.58 gph, 18" emitter spacing, 100' coil
PCB-418-010	0.92 gph, 18" emitter spacing, 100' coil
PCB-212-025	0.58 gph, 12" emitter spacing, 250' coil
PCB-412-025	0.92 gph, 12" emitter spacing, 250' coil
PCB-218-025	0.58 gph, 18" emitter spacing, 250' coil
PCB-418-025	0.92 gph, 18" emitter spacing, 250' coil
PCB-212-050	0.58 gph, 12" emitter spacing, 500' coil
PCB-412-050	0.92 gph, 12" emitter spacing, 500' coil
PCB-218-050	0.58 gph, 18" emitter spacing, 500' coil
PCB-418-050	0.92 gph, 18" emitter spacing, 500' coil
17MM PURPLE PC DRIPLINE (EFFLUENT)	
PCB-212-025-E	0.58 gph, 12" emitter spacing, 250' coil, effluent
PCB-412-025-E	0.92 gph, 12" emitter spacing, 250' coil, effluent
PCB-218-025-E	0.58 gph, 18" emitter spacing, 250' coil, effluent
PCB-418-025-E	0.92 gph, 18" emitter spacing, 250' coil, effluent

LENGTH OF RUN CHART

INLET PRESSURE (PSI)	EMITTER FLOW RATE (GPH)			
	0.58	0.58	0.92	0.92
	EMITTER SPACING (INCHES)			
	12 in.	18 in.	12 in.	18 in.
15	169	236	125	175
20	230	323	171	239
25	270	379	200	282
30	301	424	222	314
35	327	460	242	341
40	349	492	258	364
45	369	521	273	386
50	387	547	286	405
55	404	570	299	422
60	420	593	310	439

Specifying Information – Drip In PC

PCB-XXX-XXX-X				
Tubing Type	Emitter Flow	Emitter Spacing	Coil Length	Optional
PCB	X	XX	XXX	X
PCB	2 – 0.58 gph 4 – 0.92 gph	12 – 12" 18 – 18"	010 – 100' 025 – 250' 050 – 500'	E - Effluent

Example: A 250' coil of pressure-compensating Drip In brown dripline with 12" emitter spacing and 0.58 gph emitter flow would be specified as **PCB-212-025**



BLUE STRIPE® POLYETHYLENE HOSE

FEATURES & BENEFITS

Manufactured From Premium Grade Linear Low Density Polyethylene

For dependable long-lasting operation.

Minimum 2% Carbon Black Added

To provide optimum protection against ultraviolet (UV) deterioration.

Available With Blue, White or Lavender Stripe

For easy on-site identification of drip zones or applications during installation and operation.

Wide Range of Choices

Available in a wide range of diameters, wall thicknesses, coil lengths and working pressures.



Effluent
Options
Available



BLUE STRIPE® MICRO-DISTRIBUTION HOSE

ID CONTROLLED HOSE							
Part Number	Hose Size	Nominal Hose Size			Coil Length	Coil Ship Weight	Pressure Rating
	ID Inch	ID Inch	OD Inch	Wall Inch	Ft.	Lbs.	psi
Blue Stripe Round Hose - Coil Stretch Wrapped							
T-EHW0437-100	1/4"	0.170	0.250	0.040	1,000	9.64	161
Blue Stripe Round Hose - Coil Banded							
T-EHD0437-010	1/4"	0.170	0.250	0.040	100	1.1	161

BLUE STRIPE POLYETHYLENE HOSE

ID CONTROLLED HOSE							
Part Number	Hose Size	Nominal Hose Size			Coil Length	Coil Ship Weight	Pressure Rating
	ID Inch	ID Inch	OD Inch	Wall Inch	Ft.	Min. Lbs.	psi
Blue Stripe® Round Hose – Coil Stretch Wrapped							
T-EHW1645-010	5/8"	0.615	0.705	0.045	100	4.0	61
T-EHW1645-050	5/8"	0.615	0.705	0.045	500	19.8	61
Blue Stripe® Round Hose - Coil Banded							
T-EHD1554-050A (palletized)	-	0.570	0.680	0.055	500	21.5	77
P,X T-EHD1645-050A (palletized)	5/8"	0.615	0.705	0.045	500	18.9	61
P,X T-EHD2057-050A (palletized)	3/4"	0.805	0.920	0.057	500	31.2	59
T-EHD2667-066A (palletized)	1"	1.060	1.195	0.067	660	63.3	53

Note: For the two designated part numbers above, replace "D" with "P" in the part number to specify Purple Hose for reclaimed water. For the same two designated part numbers above, replace "D" with "X" in the part number to specify White Stripe Hose.

BLUE STRIPE POLYETHYLENE HOSE MODEL LIST

Model	Description
MICRO-DISTRIBUTION HOSE - COIL STRETCH WRAPPED	
T-EHW0437-100	1/4"; ID: 0.170"; OD: 0.250"; Wall: 0.040"; 1,000' coil
MICRO-DISTRIBUTION HOSE - COIL BANDED	
T-EHD0437-010	1/4", ID-0.170", OD-0.250", Wall-0.040", 100' coil
INSIDE DIAMETER (ID) CONTROLLED - COIL STRETCH WRAPPED	
T-EHW1645-010	5/8"; ID: 0.615"; OD: 0.705"; Wall: 0.045"; 100' coil
T-EHW1645-050	5/8"; ID: 0.615"; OD: 0.705"; Wall: 0.045"; 500' coil
INSIDE DIAMETER (ID) CONTROLLED - COIL BANDED	
T-EHD1554-050A	ID: 0.570"; OD: 0.680"; Wall: 0.055"; 500' coil (palletized)
T-EHD1645-050A	5/8"; ID: 0.615"; OD: 0.705"; Wall: 0.045"; 500' coil (palletized)
T-EHD2057-050A	3/4"; ID: 0.805"; OD: 0.920"; Wall: 0.057"; 500' coil (palletized)
T-EHD2667-066A	1"; ID: 1.060"; OD: 1.195"; Wall: 0.067"; 660' coil

Model	Description
LAVENDER STRIPE ROUND HOSE	
INSIDE DIAMETER (ID) CONTROLLED - COIL BANDED	
T-EHP1645-050A	5/8", ID-0.615", OD-0.705", Wall-0.045", 500' coil (palletized)
T-EHP2057-050A	3/4", ID-0.805", OD-0.920", Wall-0.057", 500' coil (palletized)
WHITE STRIPE™ ROUND HOSE	
INSIDE DIAMETER (ID) CONTROLLED - COIL BANDED	
T-EHX1645-050A	5/8", ID-0.615", OD-0.705", Wall-0.045", 500' coil (palletized)
T-EHX2057-050A	3/4", ID-0.805", OD-0.920", Wall-0.057", 500' coil (palletized)

Specifying Information—Blue Stripe Polyethylene Hose

T-EH-X-XX-XX-XXX-A				
Model	Stripe Color/Packaging	Tube Size (ID)	Wall Thickness	Optional
T-EH	X	XX	XX	A
T-EH - Blue Stripe Hose	D - Blue Stripe/Coil Banded W - Blue Stripe/Stretch Wrapped P - Lavender Stripe/Coil Banded X - White Stripe/Coil Banded	04 - 4mm (.17") 15 - 15mm (.57") 16 - 16mm (.62") 20 - 20mm (.81") 26 - 26mm (1.06")	37 - .037" 45 - .045" 54 - .054" 57 - .057" 67 - .067"	A - Palletized

TRI-LOC™ FITTINGS

FEATURES & BENEFITS

- Fits 16, 17 & 18mm OD Hose and Dripline
- 1 Fitting – 3 Tubing Sizes – Save Time!
- Superior Retention Strength
- Ergonomic Collars Reduce Fatigue
- Easy to Reuse – Save Money!



<p>TL-C Tri-Loc Coupling</p>	<p>TL-E Tri-Loc Elbow</p>	<p>TL-T Tri-Loc Tee</p>	<p>TL-M50 Tri-Loc 1/2" MPT Adapter</p>
<p>TL-M75 Tri-Loc 3/4" MPT Adapter</p>	<p>TL-FH75 Tri-Loc 3/4" FHT Adapter</p>	<p>TL-T-F50 Tri-Loc 1/2" FPT Tee</p>	<p>TL-T-M50 Tri-Loc 1/2" MPT Tee</p>
<p>TL-T-S50 Tri-Loc 1/2" Slip Tee</p>	<p>TL-CAP Tri-Loc MHT Cap</p>	<p>TL-BV Tri-Loc Ball Valve Coupling</p>	<p>TL-C-HDR 20mm OD x 20mm OD Coupling</p>
<p>TL-M75-HDR 20mm OD Hose x 3/4" MPT Adapter</p>	<p>TL-CAP-HDR 20mm OD Hose x MHT Cap</p>	<p>TL-T-HDR Tri-Loc reducing header tee connects 16, 17 and 18mm OD dripline and drip hose to Toro® T-EHD2057 hose with .805 ID. TL-T-HDR fitting also works with hose ID of .790 - .845" (20 - 21.5mm)</p>	

DRIP FITTINGS AND ACCESSORIES

18mm Fittings

- Fits 18mm OD (5/8" ID) DL2000
- Fits Blue Stripe hose "1645" models



Specifying Information— 18mm Fittings

Model	Description
I620-C	Insert Coupling
I620-E	Insert Elbow
I620-T	Insert Tee
I620-M50	1/2" MPT Adapter

17mm Fittings

- Fits 17mm OD (1/2" ID) Drip In
- Fits model Blue Stripe hose "1554" models



Specifying Information— 17mm Fittings

Model	Description
I560-C	Coupling
I560-E	Elbow
I560-T	Tee
I560-M50	1/2" MPT Adapter
I560-M75	3/4" MPT Adapter
I560-T-M50	1/2" MPT Adapter



T-YD-500-34 T-FCH-H-FIPT T-FPG02 T-FCH-H-FHT



T-FJQ16 T-IPS1500 T-SS6-50

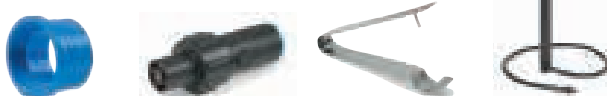

T-CA-710 T-CEFCH-H T-FMP16 T-DL-MP9

Specifying Information Accessories

Model	Description
T-YD-500-34	Air Vent—1/2" MIPT Air Release & Vacuum Relief Valve
T-FCH-H-FIPT	Flush Valve—3/4" FPT (Pipe Thread), 0.8 gpm, 2 psi Sealing Pressure
T-FCH-H-FHT	Flush Valve—3/4" FHT (Hose Thread), 0.8 gpm, 2 psi Sealing Pressure
T-DL-MP9	DL2000 Pop-up Operation Indicator
T-FJQ16	5/8" Figure-eight End Clamp
T-SS6-50	3/4" Steel Soil Staple to Hold Tubing in Place
T-IPS1500	5/8" Plastic Stake to Hold Tubing in Place
T-FPG02	Double-sided Goof Plug
T-CA-710	OD Compression Adapter 1/2" Spigot
T-CEFCH-H	OD Compression Adapter with Flush Valve, 0.8 gpm, 2 psi Sealing
T-FMP16	Stainless Steel Insertion Tool for 1/4" Barbed Fittings and Emitters
570-DRIP-IND	Pop-up Drip Operation Indicator



T-FCC0400 T-FTT0400 T-FEE0400 T-FCV-BB



T-FMP08 T-IPS0104

Specifying Information—Microline 1/4" Fittings

Model	Description
T-FTT0400	Tee (Barb x Barb)
T-FEE0400	Elbow (Barb x Barb)
T-FCC0400	Coupling (Barb x Barb)
T-FCV-BB	Microflow Valve (Barb x Barb)
T-FMP08	Hose Punch for 1/4" barbed fittings and emitter
T-IPS0104	1/4" plastic locator stake to hold tubing in place

Specifying Information—0.710 OD Compression Fittings

Model	Description
T-CA-710	OD Compression Adapter 1/2" Spigot
T-CEFCH-H	OD Compression Adapter with Flush Valve, 0.8 gpm, 2 psi Sealing



NGE[®] EMITTERS

FEATURES & BENEFITS

Uniform Flow Rates

Make the NGE ideal for use in difficult topographical conditions.

Unique Emitter Design And Pressure Compensating Diaphragm

Allows the emitter to self-flush during operation and shut-down to facilitate cleaning. This ensures the emitter is free of debris at start-up and during the emitter operation.

Low Coefficient of Variation (CV)

As tested by Toro and independent labs, the NGE is one of the best performing pressure-compensating emitters available.



The new T-DPC-TOOL insertion tool makes installing new self-piercing NGE emitters simple!



T-DPCT02-MA-BLUE-S

T-DPCT04-MA-BLK-S

T-DPCT08-MA-RED-S



T-DPCT02-DC-BLUE-S

T-DPCT04-DC-BLK-S

T-DPCT08-DC-RED-S



T-DPCT02-4-BLUE-S

T-DPCT04-4-BLK-S

T-DPCT08-4-RED-S



T-DPC-TOOL

New ¼" barbed outlet option allows for easily connecting ¼" hose downstream of the emitter.



All new self-piercing inlet comes standard on all NGE models.

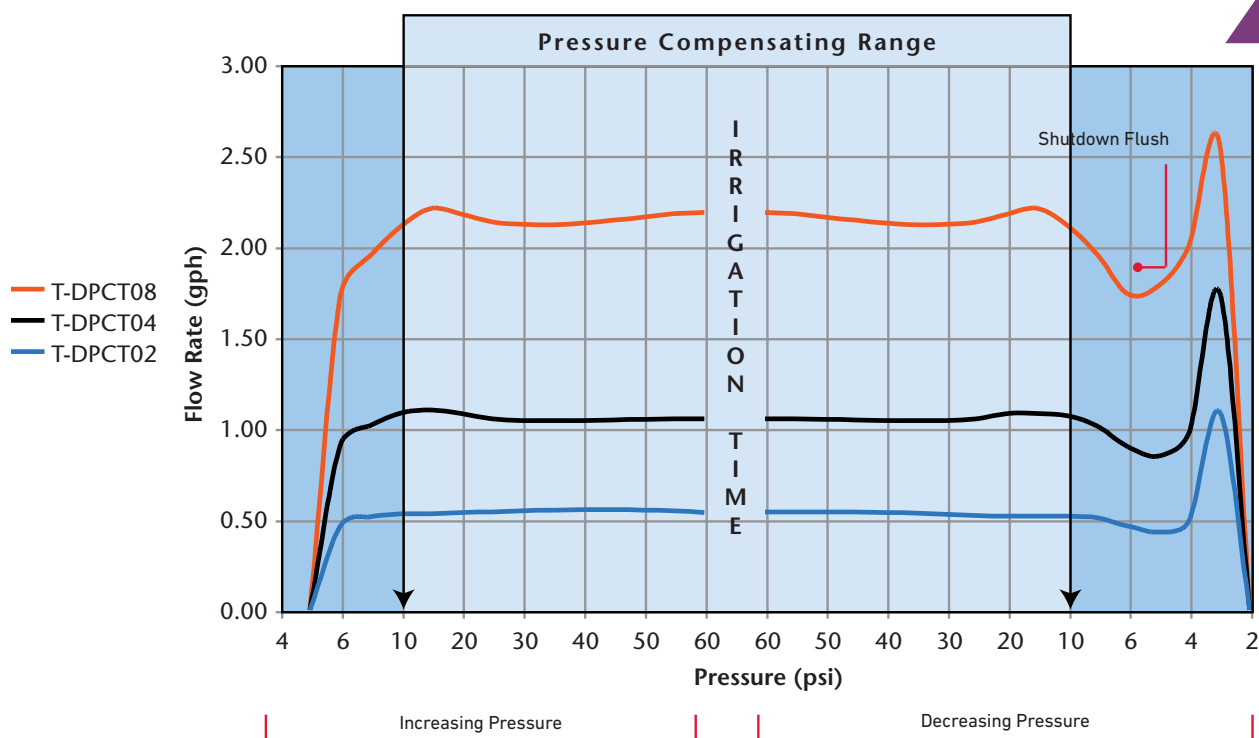

NGE PERFORMANCE TABLE

		T-DPCT02	T-DPCT04	T-DPCT08
Nominal Flow Rate (Q)	gph	0.5 gph	1.0 gph	2.1 gph
Recom. Pressure Range (P)	psi	8–60 psi		
Min. Filtration Requirement		140 Mesh (105 Micron)		
Color (Base)		Blue	Black	Red

NGE FLOW RATES

Pressure psi	T-DPCT02 gph	T-DPCT04 gph	T-DPCT08 gph
6	0.46	0.91	1.73
8	0.51	1.01	1.95
10	0.53	1.08	2.11
15	0.53	1.10	2.21
20	0.53	1.08	2.17
25	0.54	1.05	2.13
30*	0.54	1.04	2.12
35	0.55	1.04	2.12
40	0.55	1.04	2.12
45	0.55	1.04	2.14
50	0.55	1.05	2.16
55	0.54	1.05	2.18
60	0.54	1.05	2.18

*Recommended operating pressure

SPECIFICATIONS

Operational

- Recommended operating pressure: 8–60 psi
- Average Flow Rates:
 - T-DPCT02 – 0.5 gph
 - T-DPCT04 – 1.0 gph
 - T-DPCT08 – 2.1 gph
- Snap-on dust cap deters dust and insects from entering the emitter
- Standard self-piercing inlet allows emitters to be installed directly into hose without the need to punch a hole beforehand, or can be installed at the end of ¼" hose
- New ¼" outlet version allows for installation of ¼" hose downstream of the emitter

Warranty

- Two years

NGE MODEL LIST

Model	Description
T-DPCT02-MA-BLUE-S	0.5 gph NGE emitter with male adapter outlet
T-DPCT04-MA-BLK-S	1.0 gph NGE emitter with male adapter outlet
T-DPCT08-MA-RED-S	2.1 gph NGE emitter with male adapter outlet
T-DPCT02-DC-BLUE-S	0.5 gph NGE emitter with dust cap outlet
T-DPCT04-DC-BLK-S	1.0 gph NGE emitter with dust cap outlet
T-DPCT08-DC-RED-S	2.1 gph NGE emitter with dust cap outlet
T-DPCT02-4-BLUE-S	0.5 gph NGE emitter with ¼" barbed outlet
T-DPCT04-4-BLK-S	1.0 gph NGE emitter with ¼" barbed outlet
T-DPCT08-4-RED-S	2.1 gph NGE emitter with ¼" barbed outlet
T-DPC-TOOL	NGE self-piercing emitter insertion tool

Specifying Information—NGE® Emitters

T-DPCTXX-XX-XXXX-S				
Model	Flow	Outlet	Base Color	Inlet
T-DPCT	XX	XX	XXXX	S
T-DPCT – NGE Emitter	02 – 2 liter (0.5 GPH) 04 – 4 liter (1.0 GPH) 08 – 8 liter (2.1 GPH)	MA – Male Adapter DC – Dust Cap 4 – 4mm (1/4") Barb	BLUE – Blue (2 liter) BLK – Black (4 liter) RED – Red (8 liter)	S – Self-Piercing

Example: A 4 liter (1.0 GPH) NGE emitter with a 4mm (¼") barbed outlet and self-piercing inlet would be specified as: **T-DPCT04-4-BLK-S**



TURBO-SC™ PLUS PRESSURE-COMPENSATING EMITTER



FEATURES & BENEFITS

Take-Apart Feature

Permits fast, easy on-site inspection and cleaning.

Large Self-Flushing, Turbulent Flow Path

For higher resistance to plugging where water conditions may be a problem.

Male Adapter with Bug Shield

Deters the entry of insects, but also can be used with 1/4" exit tubing for precision water placement.



0.5 gph



1.0 gph



2.0 gph

SPECIFICATIONS

Operational

- Proven PC (pressure-compensating) emitter design
- Barbed inlet allows emitters to be installed directly onto hose or used with 1/4" tubing
- High quality diaphragm for improved pressure compensation and uniformity over a wide range of pressure
- Half inch FPT version comes standard with check valve screen with 12' hold back

Warranty

- One year

Specifying Information—Turbo-SC Plus

Model	Description
T-DPJ02-3	0.5 gph PC Emitter
T-DPJ04-3	1.0 gph PC Emitter
T-DPJ08-3	2.0 gph PC Emitter
T-DPJ02-F50	0.5 gph PC Emitter with 1/2" FPT Inlet and Check Screen
T-DPJ04-F50	1.0 gph PC Emitter with 1/2" FPT Inlet and Check Screen
T-DPJ08-F50	2.0 gph PC Emitter with 1/2" FPT Inlet and Check Screen

FLOW RATE

psi	T-DPJ02	T-DPJ04	T-DPJ08
5	0.42	0.73	1.41
10	0.44	0.97	1.80
15	0.47	0.96	2.00
20	0.49	0.97	2.12
25	0.50	1.00	2.15
*30	0.51	1.01	2.15
35	0.51	1.01	2.11
40	0.50	1.00	2.04
45	0.49	0.98	1.95
50	0.47	0.95	1.84
55	0.45	0.91	

*Recommended operating pressure. Values listed in gallons per hour.

TURBO-SC PERFORMANCE TABLE

		T-DPJ02-A	T-DPJ04-A	T-DPJ08-A
Nominal Flow Rate (Q)	gph	0.5 gph	1.0 gph	2.0 gph
Recom. Pressure Range (P)	psi	10–50 psi		
Min. Filtration Requirement		140 Mesh (105 Micron)		
Color (Base)		Blue	Black	Red

VARIS™ AND VARISTAKE™ ADJUSTABLE EMITTERS



FEATURES & BENEFITS

Available as Stake Assembly or as Barbed Emitter

Varistake connects to 1/4" micro-tube (T-EHD0437) for precise placement at plant. Varis emitter installs directly onto drip lateral.

Adjustable Flow Rate

Allows for ease of installation even to the smallest of areas.

Easy to Maintain

Green top unthreads completely to permit easy inspection and cleaning.

Specifying Information—Varis and Varistake Emitters

Model	Description
T-DAK05	Varis Adjustable Emitter with 1/4" Barbed Inlet
T-DAK15	Varistake Adjustable Emitter with 4 3/4" Stake and 1/4" Barbed Inlet



VARIS AND VARISTAKE ADJUSTABLE EMMITERS MODEL LIST

Diameter of Throw (maximum opening at 30 clicks):		
psi	AT 1" HEIGHT	AT 2.5" HEIGHT
20	6"	8"
30	13 1/2"	15 1/2"
40	21"	27"

Varis and Varistake Flows:	
psi	FLOW RANGE
10	0-7 gph
20	0-10 gph
30	0-11 gph
40	0-14 gph

PRESSURE REGULATING MULTI-OUTLET DRIP MANIFOLD

FEATURES & BENEFITS

- Built-in 25 psi pressure regulator delivers consistent, reliable, low-volume irrigation.
- Barbed outlets (9) accept 1/4" micro-tube & emitters, micro-bubblers or micro-sprays – ideal for mixed planting areas.
- Small shut-off caps provided with unit seal unused outlets.
- When system is off, cover unthreads for access to screen without disturbing 1/4" micro-tube connected to outlets.



SPECIFICATIONS

Operational

- 1/2" FPT Inlet
- Operating Pressure: 20 – 100 psi
- Manifold Outlet Pressure: 21 – 28 psi
- Manifold Flow Range: 1 – 210 gph
- Individual Outlet Flow Range: 1 -20 gph
- Barbed outlets accept 1/4" tubing: ID: .170 - .188

Warranty

- One year

Specifying Information—Pressure Regulating Drip Manifold

Model	Description
T-PR25-9	Pressure Regulating 9-outlet Drip Manifold



SPRAY-TO-DRIP RETROFIT KIT

FEATURES & BENEFITS

Convenient All-in-One Design

Filtration and pressure regulation are critical when installing low-flow drip irrigation systems. Toro's Spray-to-Drip Retrofit Kit conveniently contains both components in a single compact spray body footprint. There is no need to install any additional parts at the zone valve.

Easy to Connect

A Toro Tri-Loc™ tee is included with each Spray-to-Drip Retrofit Kit to easily connect to almost any common size or type of dripline or drip hose (16mm to 18mm OD).

Design Flexibility

Most jobs only require one Spray-to-Drip Retrofit Kit per zone, however for jobs where multiple points of connection to dripline or hose are required, multiple kits may be used.



Model 570-CAP

Model SXD-RETRO

SPECIFICATIONS

SXD-RETRO

- Inlet: 1/2" FPT
- Outlet: 1/2" MPT (with Tri-Loc™ model TL-T-F50 included)
- Flow rate: 0.5 to 6 gpm
- Regulated outlet pressure: 25 psi
- Recommended operating pressure: 15-70 psi
- Filtration: 200 mesh

570-CAP

- Recommended operating pressure: 0-75 psi

Warranty

- Two years

SPRAY-TO-DRIP RETROFIT KIT MODEL LIST

Model	Description
SXD-RETRO	Spray-to-Drip Retrofit Kit with internal 25 psi pressure regulator and filter
570-CAP	570 plug cap

SXD-RETRO SPRAY-TO-DRIP RETROFIT KIT INCLUDES



SPRAY-TO-DRIP RETROFIT KIT EXAMPLE INSTALLATION

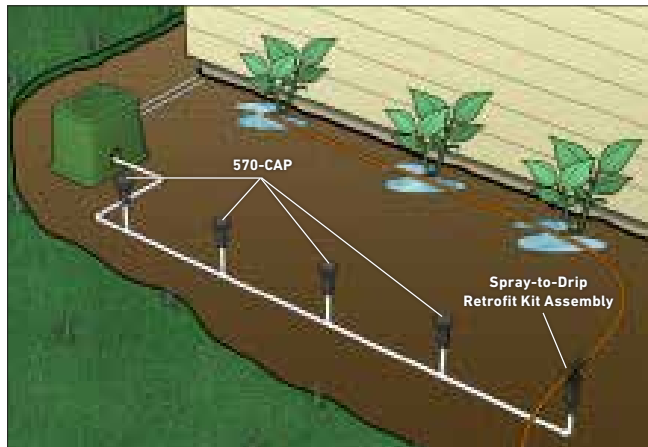



E-2™ CLASSIC TAKE APART EMITTER

FEATURES & BENEFITS

Fast Single Barb Installation

Install directly onto hose.

Large Open Flow Path

For resistance to plugging.

Take-Apart Feature

Allows fast simple field inspection.



SPECIFICATIONS

Operational

- Flow Rates:
 - T-DBK04-100 – 1.0 gph
 - T-DBK08-RED-100 – 2.0 gph
 - T-DBK16-MB-100 – 4.0 gph
- Proven Classic hydraulic design
- Economic emitter for trouble-free applications
- Barbed inlet allows emitters to be installed directly onto hose or used with 1/4" leader tubing (T-EHD0437)
- Exit barb may be used with 1/4" exit tubing for precision water placement

Warranty

- One year

E-2 EMITTER FLOW RATE

psi	T-DBK04	T-DBK08	T-DBK16
5	0.58	1.03	2.09
10	0.88	1.53	3.08
15	1.12	1.93	3.87
20	1.33	2.27	4.55
25	1.52	2.58	5.15
30	1.70	2.87	5.71
35	1.87	3.13	6.23
40	2.03	3.38	6.71
45	2.17	3.62	7.17
50	2.32	3.84	7.61

*Recommended operating pressure. Values listed in gallons per hour.

E-2 EMITTER PERFORMANCE

		T-DBK04	T-DBK08	T-DBK16
Nominal Flow Rate (Q)	gph @ 15 psi	1.06 gph	2.11 gph	4.23 gph
Operating Pressure Range (P)	psi	0–50 psi		
Minimum Filtration Requirement		140 Mesh (105 Micron)		

Specifying Information—E-2 Classic Emitter

Model	Description
T-DBK04-100	1.06 gph E-2 Emitter (Black)
T-DBK08-RED-100	2.11 gph E-2 Emitter (Red)
T-DBK16-MB-100	4.23 gph E-2 Emitter (Maroon)





DRIP BUBBLERS



FEATURES & BENEFITS

Easy to Install

Easily threads on to a 1/2" threaded riser. The self-sealing screen eliminates the cost and labor of having to use plumber's tape on every riser.

Easy to Maintain

Self-cleaning mechanism flushes at every startup, ensuring reliable operation and fewer maintenance headaches.

Durable Construction

Commercial-grade plastic and chloramine-stabilized silicone diaphragm provide dependable UV- and chemical-resistant performance in the least forgiving of environments.



Drip Stream Bubblers

Drip Bubblers

SPECIFICATIONS

Operational

- Comes standard with check valve screen with 12' hold back
- Pressure Compensation: 20 – 60 psi
- Recommended operating pressure: 30 psi
- Minimum Filtration Requirement: 80 Mesh
- 1/2" FIPT inlet; diffuser cap outlet
- Flow rate molded onto the bubbler for easy identification
- Effluent and non-effluent models
- Installation of pressure-regulating drip zone kit recommended for optimal performance
- Drip Stream Bubblers models feature a unique four-outlet configuration with removable caps to ensure water does not trickle straight down to the PVC riser base if mounted vertically

Warranty

- Two years

LOW FLOW BUBBLERS MODEL LIST

Model	Description
DB-04-PC	4 GPH PC Drip Bubblers (0.067 gpm)
DB-09-PC	9 GPH PC Drip Bubblers (0.15 gpm)
DB-15-PC	15 GPH PC Drip Bubblers (0.25 gpm)
DB-30-PC	30 GPH PC Drip Bubblers (0.5 gpm)
DB-04-PC-E	4 GPH PC Drip Bubblers, Effluent (0.067 gpm)
DB-09-PC-E	9 GPH PC Drip Bubblers, Effluent (0.15 gpm)
DB-15-PC-E	15 GPH PC Drip Bubblers, Effluent (0.25 gpm)
DB-30-PC-E	30 GPH PC Drip Bubblers, Effluent (0.5 gpm)
DSB-04-PC	4 GPH PC Drip Stream Bubblers (0.067 gpm)
DSB-08-PC	8 GPH PC Drip Stream Bubblers (0.13 gpm)
DSB-04-PC-E	4 GPH PC Drip Stream Bubblers, Effluent (0.067 gpm)
DSB-08-PC-E	8 GPH PC Drip Stream Bubblers, Effluent (0.13 gpm)

PLASTIC Y-FILTERS

FEATURES & BENEFITS

1/2" Male Thread Outlet

With cap for quick flush cleaning.

Easy Element Access

For trouble free maintenance.

Constructed of Highest Quality Plastics

For durability and corrosion resistance.



SPECIFICATIONS

Operational

- Recommended pressure range: 5 – 120 psi
- Flow Rate: 5 – 80 gpm
- 3/4" and 1" screen filters are available in small- and large-size bodies
- Body and cap constructed of nylon
- Locking ring constructed of glass reinforced nylon
- O-ring constructed of Buna-N

Dimensions

- L: 11 1/2" H x 9" W x 9" D
- S: 8" H x 5 1/2" W x 5 1/2" D

Warranty

- One year

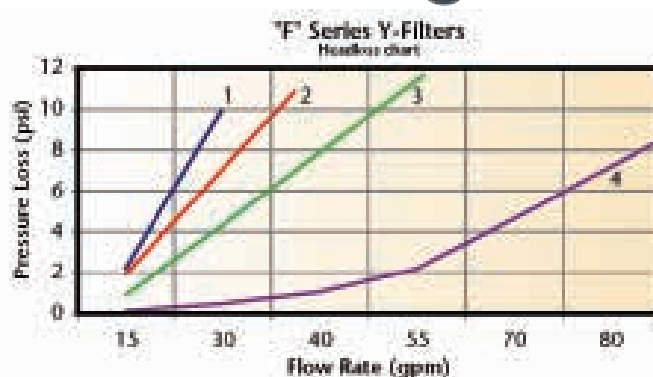

Specifying Information—Plastic Y-Filters (Disc)

Model	Size	Maximum Flow	Element	Mesh	Body	Head Loss Curve
T-ALFD75150-L	3/4"	25 gpm	Disc	150	Large	2
T-ALFD10150-L	1"	35 gpm	Disc	150	Large	3
T-ALFD15150-L	1 1/2"	80 gpm	Disc	150	Large	4

Specifying Information—Plastic Y-Filters (Screen)

Model	Size	Maximum Flow	Element	Mesh	Body	Head Loss Curve
T-ALFS75150-S	3/4"	18 gpm	Screen	150	Small	1
T-ALFS75150-L	3/4"	25 gpm	Screen	150	Large	2
T-ALFS10150-S	1"	25 gpm	Screen	150	Small	2
T-ALFS10150-L	1"	35 gpm	Screen	150	Large	3
T-ALFS15150-L	1 1/2"	80 gpm	Screen	150	Large	4

Specifying Information—Replacement Screen/Disc Filter Elements

Model	Size	Element	Mesh	Body
T-AMP-0004-4F	3/4", 1" and 1 1/2"	Disc	150	Large Body Size Filters
T-AMP0004-1S	3/4" and 1"	Screen	150	Small Body Size Filters
T-AMP0004-2F	3/4", 1" and 1 1/2"	Screen	150	Large Body Size Filters

PRESSURE REGULATORS

Specifying Information—Pressure Regulators

Model	Description
T-PMR30	1", 30 psi, 0.1-35 gpm pressure regulator
T-PMR40	1", 40 psi, 0.1-35 gpm pressure regulator





DRIP ZONE VALVE KITS

FEATURES & BENEFITS

Compact Pressure-Regulating Filter Option

New compact pressure-regulated filter option (low-flow models only) comes fully pre-assembled with the valve*

Complete with Irritrol Control Valve

Over half a century of industry-recognized dependability

Filter and Regulator Included

A must-have for protecting drip systems from debris and excess pressures

Available in a Variety of Configurations

Multiple configurations to handle all installation variances

Also Available in “Less Valve” Configurations

Allows for installation versatility

Medium-flow models with separate filter and regulator



MODEL	GPM (Flow)	0.25	5	8	15	20
2713APRDK-MF	Friction loss (psi)	3	5	5	5	8
	Inlet (psi)	30	32	32	32	35
2500DK-1-MF	Friction loss (psi)	3	3	3	4.5	7
	Inlet (psi)	30	30	30	32	34
2507DK-MF	Friction loss (psi)	3	5	5	7	13
	Inlet (psi)	30	32	32	34	39
700DK-1-MF	Friction loss (psi)	3	3	3	4.5	7
	Inlet (psi)	30	30	30	32	34

700DK-1-LF									
	GPM								
PSI	0.25	0.2	1	2	3	5	8	10	12
30	27.0	28.0	25.3	24.6	22.3	18.6	12.6		
40	32.2	37.7	35.3	33.0	31.5	27.2	17.9	14.9	
50	45.5	43.8	37.6	36.4	37.0	33.0	26.9	22.6	15.2
60	38.6	42.2	42.4	40.7	37.3	35.7	32.0	28.1	21.9
80	40.4	40.8	42.6	43.4	43.6	38.9	40.6	37.7	34.1
100	45.3	45.1	44.6	42.2	42.5	41.8	40.7	40.4	42.4
120	44.7	44.0	46.1	45.0	46.0	41.6	45.8	46.7	45.9

2400DK-1-LF									
	GPM								
PSI	0.25	0.2	1	2	3	5	8	10	12
30	27.6	26.3	25.2	25.0	23.1	20.2	12.4		
40	37.2	35.7	35.9	32.7	32.4	28.0	20.6	12.9	
50	44.9	43.6	41.6	37.1	38.5	34.5	27.6	24.0	18.2
60	42.7	44.3	41.4	38.2	39.2	36.1	32.6	28.8	24.2
80	43.4	42.5	45.3	41.9	41.3	38.6	38.3	38.0	33.8
100	46.7	42.2	44.1	42.7	45.4	42.6	40.3	42.5	40.3
120	51.0	42.7	48.0	46.6	47.7	45.0	46.8	43.3	45.4

2500DK-1-LF									
	GPM								
PSI	0.25	0.2	1	2	3	5	8	10	12
50	44.4	43.4	37.8	37.1	35.8	33.2	28.0	23.8	17.2
60	45.6	40.7	39.3	38.3	38.7	36.9	32.3	28.7	23.1
80	42.1	45.3	40.7	41.3	39.9	41.0	42.3	38.2	33.3
100	43.9	44.3	44.0	45.1	42.5	39.9	42.4	41.5	40.3
120	48.9	46.2	44.6	43.2	45.2	44.8	45.9	44.6	45.5

2713APRDK-LF									
	GPM								
PSI	0.25	0.2	1	2	3	5	8	10	12
50	44.8	43.0	41.6	39.8	38.0	35.3	28.5	24.5	18.0
60	42.3	40.9	42.1	40.6	39.8	38.6	34.2	29.7	25.1
80	43.0	46.3	40.1	42.5	42.6	41.6	39.4	39.4	36.2
100	46.4	46.4	40.9	45.5	44.0	44.5	44.2	43.5	41.9
120	47.3	46.1	44.5	46.9	47.8	47.3	44.7	44.2	45.0

■ = Not Recommended

SPECIFICATIONS

Electrical

- Solenoid: 24 V AC
- Inrush volt-amp: 24 V AC-9.6 VA
- Inrush current: .4 amp
- Holding volt-amp: 24 V AC-4.8 VA
- Holding current: .2 amp

Warranty

- Five years

DRIP ZONE VALVE KITS MODEL LIST

Model	Description
700DK-1-LF	1" 700 UltraFlow® Inline Valve, Filter, Low Flow Regulator and Fittings
700DK-1-MF	1" 700 UltraFlow Inline Valve, Filter, Medium Flow Regulator and Fittings
700DK-075-LF	¾" 700 UltraFlow Inline Valve, Filter, Low Flow Regulator and Fittings
2500DK-1-LF	1" 2500 Valve, Filter, Low Flow Regulator and Fittings
2500DK-1-MF	1" 2500 Valve, Filter, Medium Flow Regulator and Fittings
2507DK-LF	¾" 2507 Valve, Filter, Low Flow Regulator and Fittings
2507DK-MF	¾" 2507 Valve, Filter, Medium Flow Regulator and Fittings
2711APRDK-LF	¾" 2711APR Valve, AVB, Filter, Low Flow Regulator and Fittings
2711APRDK-MF	¾" 2711APR Valve, AVB, Filter, Medium Flow Regulator and Fittings
2713APRDK-LF	1" 2713APR Valve, AVB, Filter, Low Flow Regulator and Fittings
2713APRDK-MF	1" 2713APR Valve, AVB, Filter, Medium Flow Regulator and Fittings
DK-LV-LF	Low Flow Kit Less Valve
DK-LV-MF	Medium Flow Kit Less Valve

SENSORS





SENSORS

Pages 142-163

WEATHER & MOISTURE

RainSensor™ Series	146-147
Climate Logic® System	148-149
Precision™ Soil Sensor	150-151
Pro Series™ Soil Sensor	152
Turf Guard® Wireless Soil Monitoring System	153
Wireless ET Weather Sensor	154-155

FLOW SENSORS

Flow Sensors	156
TFS Flow Sensors	157

REMOTES

TMR Maintenance Remote	158
EVOLUTION® Smart Connect® Remote	159
EICON Remote	160
Pro Max™ Remote	161
CRR Series	162



RAINSENSOR™ SERIES

FEATURES & BENEFITS

Wireless Models

Require less labor for the installer

Constant Communication Between Transmitter and Receiver

Assures that even after a controller power outage, the controller is continually updated with the sensor's "wet" or "dry" status

Versatile Mounting Options

Requires no special tools – Quick-Clip™ gutter bracket and ½" conduit adapter included

Signal Strength Indicator

Ensures correct installation, communication link and signal integrity (wireless models)

Smart Bypass™ for Easy System Override

Allows for temporary deactivation while automatically resetting on next activation (wireless models)

Fully Adjustable Shutoff Points

From 1/8" to 3/4" of accumulated rainfall

Dry-out Rate Adjustment for Reset Delay

Allows for setting the ideal dryout time

Patented Wireless Technology

Unsurpassed by the competition



RFS1000

RS1000

RS500

Additional Features

Wireless Models

- ✓ Replaceable battery
- ✓ Signal strength indicator
- ✓ Visual sensor status and alert indicators verify consistent operation
- ✓ Patented RF technology
- ✓ Slide/snap-on cover provides additional protection to weather-proof receiver from the elements
- ✓ Power failure memory protection
- ✓ Highly accurate 41°F digital activation point

Wireless Models

- ✓ 25-foot cable (UV-resistant, white jacket included) provides installation flexibility
- ✓ Easy conversion to normally open operation

PRODUCT HIGHLIGHT

Proprietary Wireless Technology

Press once to temporarily deactivate rain sensor; automatically resets on next activation

Illuminates "RED" when the rain sensor is activated

Blinking light alerts user when attention is required, e.g., need batteries replaced, no communication



Illuminates "GREEN" to

SPECIFICATIONS

Operational

- Sensor type: industry-standard hygroscopic discs
- Rain sensitivity: adjustable nominal 1/8 to 3/4"
- Operating temperature: -20°F to 120°F
- Housing material: UV-resistant engineered polymer
- Wireless only features:
 - Transmission range: up to 500' line-of-sight - Battery: Two CR2032 3V cells, 5-year life (typical)
 - Frequency: 418MHz

Electrical

- Receiver power: 22-28 V AC/V dc, 100mA (to be used with Class 2, UL-approved transformer)
- Load rating: Normally open or normally closed - 3A @ 24 V AC
- UL Listed, FCC, CE, IC

Dimensions

- Transmitter: H: 1½", W: 1¾", D: 3¾"
- Receiver: H: 1½", W: 1", D: 3"

Warranty

- Five years

RAINSENSOR™ SERIES MODEL LIST

Model	Description
RS1000	Wireless RainSensor
RFS1000	Wireless rain/freeze sensor
RS500	Wired RainSensor

Specifying Information—RainSensor Series

RXX-XXXX	
Model	Connection
RXX	XXXX
RS - Rain Sensor	500 - Wired
RFS - Rain/Freeze Sensor (wireless only)	1000 - Wireless

Example: A wireless rain/freeze sensor = **RFS1000**

VERSATILE MOUNTING OPTIONS: (ALL IN ONE SKU)



Gutter mount

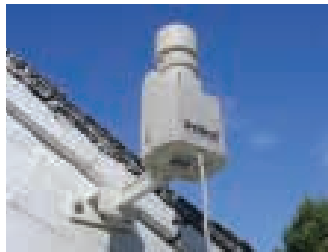

Surface mount



Pole mount



CLIMATE LOGIC® SYSTEM



Certified by
ICC-ES

FEATURES & BENEFITS

On-site Weather in Real-time

Continuously monitors temperature and sunlight to generate schedule adjustments based on what's happening at the site.

Built in Rain/Freeze Sensor

Adjustable freeze sensor and rain gauge automatically suspends irrigation in the event of precipitation and near-freezing temperatures.

Completely Wireless

Installed in minutes and powered by a single 9V battery, the sensor presents ultimate flexibility with a communication range of 1,000 feet.*

Historical Weather Information

The sensor includes a decades' worth of historical weather data for North America that is used by the controller to generate schedule adjustments in the event of communication issues due to a depleted battery.

No Fees

The sensor is self-sufficient and does not require any external data, or associated subscription fees, to operate.

**Line of sight*



CL-M1 Wireless Receiver

CL-W1 Wireless Weather Sensor

CLIMATE LOGIC® SYSTEM MODEL LIST

Model	Description
CL-100-Wireless	Wireless weather sensor & receiver kit
CL-W1	Wireless weather sensor
CL-M1	Wireless receiver module
CL-R1	Wireless maintenance remote
CL-MR	Mini-receiver
R-100-KIT	Remote control & mini receiver (complete kit)

OPTIONAL ACCESSORIES



CL-R1
Remote transmitter



CL-MR
Mini-receiver

R-100-KIT



SMRT Logic
Internet Gateway



SMRTscape
Mobile Device App

SMRT LOGIC®

ACCURATE, PINPOINT LOCATION



Site location by zip code or latitude/longitude:
-40 years historical data by location available on set-up card

ADDITIONAL FEATURES



Live graph of up to 2 years of historical water budget adjustments



Weather sensor comes paired to Climate Logic® receiver module. On large sites, several receivers can be paired to one weather sensor



"Follow the weather" on one or more programs (A only, A&B or A, B, & C)



Set a minimum temperature to shut off watering and up to 3 days of "Dry out" in 1/2 day increments after a rain event



User selectable daily update time for automatic weather adjustment

SPECIFICATIONS

Operational

- 1,000' line-of-sight signal range
- Compatible with the following Irritrol controllers:
 - Rain Dial®-R Series & earlier Rain Dial (Blue), Total Control®-R Series, KD2™ Series, MC-E Controllers ("blue" model) with CMR-ADP adapter
- One weather sensor can communicate with multiple receiver modules

PRODUCT HIGHLIGHT

Climate Logic Kit (CL-100-WIRELESS)



With the optional CLIMATE LOGIC® wireless weather sensing system, the following controllers meet or exceed the performance criteria for the EPA WaterSense® label:

- KwikDial®
- KD2
- MC-E "Blue"
- Toro Custom Command™
- Rain Dial-R®
- Total Control-R®
- Toro® TMC 424-E

Specifying Information — Climate Logic

CL-XXX-WIRELESS	
Model	Connection
CL	XXX
CL - Climate Logic	100 - Receiver & transmitter kit R1 - Remote transmitter only MR - Mini Receiver

Example: a wireless system with sensor & module = **CL-100-Wireless**

TORO.

PRECISION™ SOIL SENSOR



FEATURES & BENEFITS

Works with Nearly All Irrigation Controllers

Can be installed on any irrigation controller, including competitive models.

Prevents Overwatering

Continuously measures soil moisture levels and determines when to allow your irrigation controller to water, making sure just the right amount of water is applied.

No Digging Required

Communication between the sensor probe and the receiver is completely wireless, with up to a 500' range (line of sight). Installation doesn't disturb the soil, giving you accurate moisture readings starting as soon as the sensor is put in the ground.

Automatic Calibration

The sensor will automatically detect the soil type and adjust all calculations accordingly.

Freeze Detection

The only soil sensor to offer freeze detection that prevents irrigation when temperatures approach freezing.



Additional Features

- ✓ Sensor receiver hooks up to irrigation controller's sensor port (if available) or is wired into common wire
- ✓ Up to 500' range, line of sight
- ✓ One sensor per receiver
- ✓ Adjustable moisture threshold in 1% increments allows the user to set the desired moisture level
- ✓ Smart Bypass™ overrides the sensor for a user-defined length of time (especially useful during system winterization)
- ✓ If the sensor is tripped while the irrigation controller is in the middle of a watering program, the optional "Cycle Delay" feature ensures all subsequent zones in the irrigation program have a chance to get watered before the sensor halts watering
- ✓ Multi-color LED on the sensor probe indicates radio signal strength
- ✓ Sensor probe's ultra-slim 3/4" profile allows it to avoid being damaged by mowing equipment
- ✓ Extra long stainless-steel electrodes measure over 4" down into the soil profile
- ✓ Sensor probe's support stakes hold sensor firmly in place when installed
- ✓ Easily replaceable batteries last up to two years with alkaline batteries (longer with lithium)

PRODUCT HIGHLIGHT

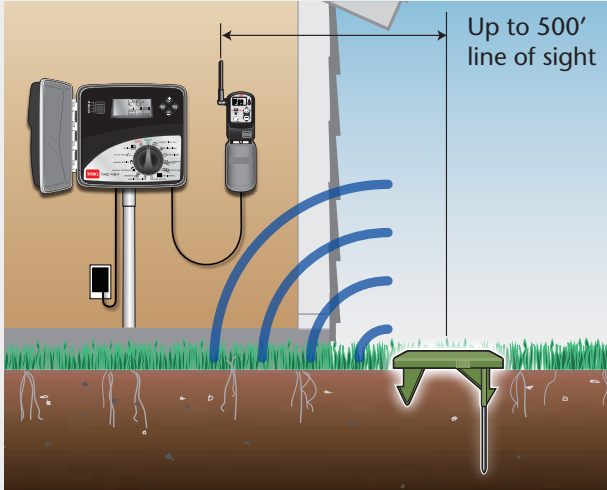

- There are two components to the system - a battery-powered wireless sensor probe and a receiver that wires into any irrigation controller's sensor port.
- Once installed, the sensor calculates field capacity for your soil (or the maximum amount of water the soil can hold after excess water has drained away) and sets that as "100%".
- Any time the moisture level in the soil exceeds field capacity, the irrigation controller is prevented from watering until the moisture level falls below the level set in the receiver (default is 50% of field capacity, adjustable by the user).

SPECIFICATIONS

Electrical

- Receiver input power: 24 Vac
- Probe: Three AA batteries

Temperature

- Operating (Probe): 14° F to 170° F
- Operating (Receiver): 14° F to 140° F
- Storage: -22° F to +149° F

Dimensions

- Probe body: 5" x 3 3/4" x 3/4"
- Probe spikes: 4 3/4"
- Receiver body: 3" x 3 3/4" x 1/2"

Warranty

- Two years

Specifying Information—Precision™ Soil Sensor

Model	Description
PSS-KIT	Universal Precision™ Soil Sensor Kit (Probe + Receiver)
PSS-SEN	Sensor Only (for use with EVOLUTION Smart Connect®)





PRO SERIES™ SOIL SENSOR



FEATURES & BENEFITS

Wireless Communication

The wireless radio communication from the sensor to the controller “base station” means no trenching or wiring required.

Ultimate Flexibility

The unique design of the probe incorporates a tether that allows measurements to be taken anywhere from just below grade to upwards of three and a half feet below the surface, making it suitable for anything from turf to large trees or anything in between.

Maximum Control

Up to 16 sensors can be used with any Sentinel controller, transmitting real-time moisture data every 5 minutes.

Easy Installation

All Sentinel controllers come standard with the port that accepts the Pro Series receiver, allowing for “plug and play” upgrades. The sensor can either be completely buried in soil for greater vandal resistance or installed in a valve box for easier servicing.

Proven Technology

The Toro Pro Series Soil Sensor leverages both hardware and proprietary programming used for over a decade on golf courses and high-profile sports fields.

SPECIFICATIONS

Operational

- Works with Sentinel® central control system to adjust watering
- Up to 16 sensors per controller
- Leverages Turf Guard® wireless communication technology
- Compatible with Turf Guard repeaters to extend range
- Replaceable battery (lasts up to 3 years after installed)

Electrical & Wireless

- Up to 500' range line-of-site from buried sensor to controller
- 900 MHz ISM Band FHSS communication
- Input power for receiver: <0.02 amps @ 6 Vdc from controller

Dimensions

- Body: 2" x 3⁵/₈" x 6¹/₈"
- Spikes: 1³/₄" x 3³/₁₆"
- Tether: 3'

Additional Options

- Toro Pro Series Soil Sensor wireless receiver (TG-B)

Warranty

- Two years

Specifying Information—Pro Series™ Soil Sensor

Model	Description
TPS-SS	Toro Pro Series Soil Sensor
TPS-RX	Toro Pro Series Internal Receiver

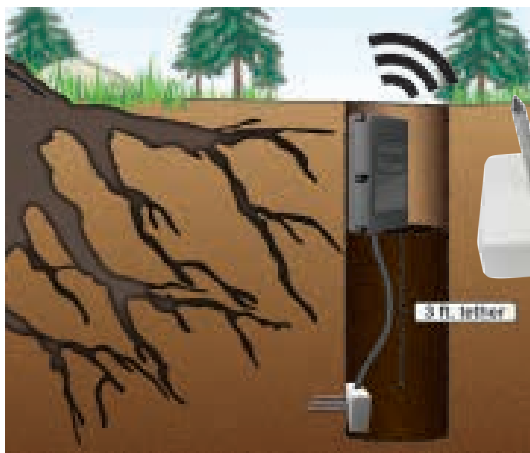

TURF GUARD® SOIL MONITORING SYSTEM

FEATURES & BENEFITS

Wireless Communication

Turf Guard's advance wireless MESH network technology makes for an easy installation with no trenching required.

Monitor Moisture Levels in the Soil

Reduce water usage and improve playability without risking turf quality. Promote root growth by avoiding over watering and detect dry areas before it impacts the turf's health.

Track Salt Build-Up and Schedule Flushing

Take the guesswork out of monitoring and managing salinity levels. Know when and how much water to flush with.

Review Daily Soil Temperatures

Predict peak soil temperatures early in the day to start remediation activities before an emergency. Schedule fungicide applications and pesticides for optimal effectiveness.

Additional Features

- ✓ Comes with free SiteVision™ software for viewing data
- ✓ Advanced MESH routing technology overcomes obstacles
- ✓ Durable sensor housing is resistant to aeration damage
- ✓ Supports up to 500 sensors per system
- ✓ Expected sensor battery life of three years, field replaceable
- ✓ Sensor reading sent every five minutes
- ✓ Measures two distinct depths in the soil profile
- ✓ Automatic network configuration and failure recovery
- ✓ Graphical system overview displays sensor data at-a-glance
- ✓ Plots trends and compares historical and current readings
- ✓ Move quickly from system-wide averages to individual sensor readings

SPECIFICATIONS

Electrical

- Input Power:
 - Repeater: <0.02 amps @ 6 Vdc
 - Base Station: <0.1 amps @ 120 Vac, 50/60 Hz

Temperature

- Operating: 32° F to 140° F
- Storage: -22° F to 180° F

Dimensions

- Body: 2" x 3⁵/₈" x 6¹/₈"
- Spikes: 1³/₄" x 3¹/₁₆"
- Installation Hole Diameter: 4¹/₄"

Communication

- Repeater Range: Up to 2,000' line-of-sight
- Buried Sensor Range: Up to 500' line-of-sight
- 900 MHz ISM Band FHSS Communication
- Additional licensing not required

Warranty

- Comes with one year of NSN® support (extended support plans available)



Specifying Information—Turf Guard

Model	Description
TG-S2-R	Turf Guard Sensor with Replaceable Battery
TG-R-INT	Repeater-Internal Mount
TG-R-EXT	Repeater-External Mount
TG-B	Base Station
TG-S2-BAT	Battery Kit



WIRELESS ET WEATHER SENSOR



FEATURES & BENEFITS

On-site Weather in Real-time

Continuously monitors temperature and sunlight to generate schedule adjustments based on what's happening at the site.

Built in Rain/Freeze Sensor

Adjustable freeze sensor and rain gauge automatically suspends irrigation in the event of precipitation and near-freezing temperatures.

Completely Wireless

Installed in minutes and powered by a single 9V battery, the sensor presents ultimate flexibility with a communication range of 1,000 feet.*

Historical Weather Information

The sensor includes a decades' worth of historical weather data for North America that is used by the controller to generate schedule adjustments in the event of communication issues due to a depleted battery.

No Fees

The sensor is self-sufficient and does not require any external data, or associated subscription fees, to operate.

**Line of sight*

Additional Features

- ✓ Sensor data and schedule adjustments viewable on-demand through EVOLUTION Review screens
- ✓ QuickClip™ mounting arm
- ✓ Automatic freeze shutoff feature prevents watering when temperatures approach freezing
- ✓ Low battery indicator and alert in the EVOLUTION controller
- ✓ Dryout days are adjustable between 0-14 days after a rain event
- ✓ One sensor can support multiple controllers within range



Certified by
ICC-ES

EPA WaterSense approved when
equipped on an EVOLUTION controller

SPECIFICATIONS

Operational

- Sensor wirelessly connects with the EVOLUTION Series controller via the Smart Connect receiver (EVO-SC, sold separately)
- Up to 1000' range, line of sight
- FCC Approved

Electrical

- 9 Vdc Battery

Temperature

- Operating: -14° F to 140° F
- Storage: -22° F to 149° F

Dimensions

- 6" x 6 1/2" x 2 3/4" (mounting arm extended)

Warranty

- Five years



Wireless ET Weather Sensor



EVOLUTION® Series controller and Smart Connect® receiver

HOW IT WORKS

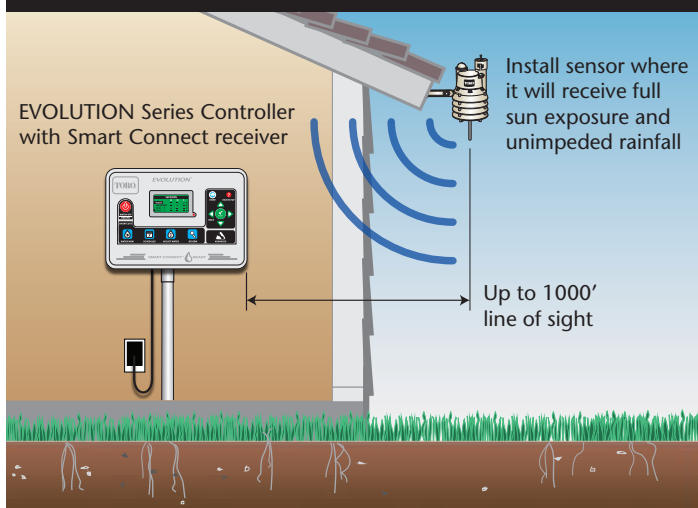

TWO MOUNTING OPTIONS:

QuickClip™ Gutter Bracket

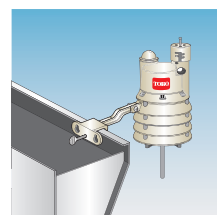

Wall Mount

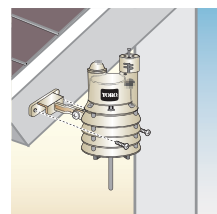

Specifying Information—Wireless ET Weather Sensor

Model	Description
EVO-WS	Wireless ET Weather Sensor for use with EVOLUTION Series controller (equipped with Smart Connect receiver)



FLOW SENSORS



FEATURES & BENEFITS

PLASTIC FLOW SENSORS

T-type PVC Flow Sensors

Available in 1.5" thru 4" diameters. Flow ranges from 0.6 GPM to 500 GPM rated up to 240 PSI.

Saddle Type Adapters

Available in 3", 4", and 6" diameters. Flow ranges from 2 GPM to 1,100 GPM rated up to 400 PSI.

Available in Both Schedule 40 and Schedule 80 PVC

To meet varying needs.

BRASS FLOW SENSORS

T-type BRASS Flow Sensors

Available in 1" thru 2.5" diameters. Flow ranges from 0.6 GPM to 160 GPM rated up to 400 PS



A \$500 flow sensor could have prevented \$250,000 damage.*
*actual savings will vary



Flow Sensor Model	Pipe Connection Size	Suggested Operating Range	Maximum Water Pressure	K Value	Offset Value	Body Material	Connection Type
FS-B100	1"	2-40 GPM	400 psi	109	27	Brass	NPT female
FS-B125	1 ¼"	3-60 GPM	400 psi	209	32	Brass	NPT female
FS-B150	1 ½"	4-80 GPM	400 psi	291	24	Brass	NPT female
FS-B200	2"	10-100 GPM	200 psi	750	0	Brass	NTP female with copper male adapter
FS-B250	2 ½"	16-160 GPM	200 psi	1021	370	Brass	NTP female
FS-150	1 ½"	5-100 GPM	100 psi @ 68F	457	0	PVC	Slip
FS-200	2"	10-200 GPM	100 psi @ 68F	776	104	PVC	Slip
FS-300	3"	20-300 GPM	100 psi @ 68F	2268	483	PVC	Slip
FS-400	4"	40-500 GPM	100 psi @ 68F	3752	834	PVC	Slip
FS-10*	1"	.86 - 52 GPM	240 PSI	87	6	PVC	SOCKET
FS-B15*	1 1/2"	3 -90 GPM	250 PSI	208	34	Brass	FPT
FS-15*	1 1/2"	1.8 -108 GPM	240 PSI	177	205	PVC	SOCKET
FS-20*	2"	2.8 -170 GPM	240 PSI	325	256	PVC	SOCKET
RM-S30*	3"	6 - 288 GPM	150 PSI	751	431	PVC	SADDLE
RM-S40*	4"	10 - 480 GPM	150 PSI	1237	303	PVC	SADDLE
RM-S60*	F	45 - 1080 GPM	150 PSI	2839	903	PVC	SADDLE
FS-INSERT-B*	3 to 40 inches	Varies, call factory	400 psi	Varies, call factory		Requires pipe saddle with 2" female NPT	

TFS FLOW SENSORS



FEATURES & BENEFITS

Effective Flow Monitoring Even In Flows Lower Than 5 gpm

Effective in ranges from 1.2 gpm to 500 gpm. Teamed with the Toro® TMC-424, 1/2", 3/4" and 1" sensors provide a cost-effective flow monitoring and alarm system.

Compatible With Competitive Controllers

In addition to the Toro compatible controllers – TDC+, TMC-424E and Sentinel® – these flow sensors work with any controller or control system compatible with frequency output flow sensors (pulses per second proportional to flow velocity).

Additional Features

- ✓ Simple, yet effective impeller-based design
- ✓ Potted electronics designed for valve box or underground applications
- ✓ Sensor pre-installed in tee
- ✓ Removable sensor design for easy replacement without removal of tee
- ✓ Socket end tee



TFS SERIES FLOW SENSOR PERFORMANCE DATA

Sensor Model	TFS-050	TFS-075	TFS-100	TFS-150	TFS-200	TFS-300	TFS-400
Size	1/2"	3/4"	1.0"	1.5"	2.0"	3.0"	4.0"
K Value	00.78	0.1563	0.26112	1.699	2.8249	8.309	13.74283
Offset	0.9	0.9	1.2	-3.016	0.1435	0.227	0.23707

TFS SERIES MODEL LIST

Model	Description	Suggested Operating Range:
TFS-050	1/2" Flow Sensor	1.2-12 gpm
TFS-075	3/4" Flow Sensor	2.7-28 gpm
TFS-100	1" Flow Sensor	5-50 gpm
TFS-150	1 1/2" Flow Sensor	5-100 gpm
TFS-200	2" Flow Sensor	10-200 gpm
TFS-300	3" Flow Sensor	20-300 gpm
TFS-400	4" Flow Sensor	40-500 gpm

Specifying Information—TFS Sensor

TFS-XXX		
Model	Configuration	
TFS	XXX	
TFS—Flow Sensor	050—1/2" Plastic Tee 075—3/4" Plastic Tee 100—1" Plastic Tee 150—1 1/2" Plastic Tee	200—2" Plastic Tee 300—3" Plastic Tee 400—4" Plastic Tee

SPECIFICATIONS

Operational

- Output: Two-wire, unscaled pulse – pulse width 5msec +/- 25%
- Frequency: 3.2 to 200 Hz
- Pressure Rating:
 - 1/2", 3/4" and 1": up to 150 psi
 - 1 1/2", 2", 3" and 4": up to 100 psi
- Temperature Rating: Up to 140° F (60° C)
- Flow Range (Velocity):
 - 1/2", 3/4" and 1": 2'-20' per second
 - 1 1/2", 2", 3" and 4": 0.5'-30' per second
- Tee:
 - 1/2", 3/4" and 1": Schedule 40 PVC
 - 1 1/2", 2", 3" and 4": Schedule 80 PVC
- Sensor Housing: Potted, PPS
- Impeller:
 - 1/2", 3/4" and 1": 300SST
 - 1 1/2", 2", 3" and 4": Glass-filled nylon
- Shaft: Tungsten Carbide
- Bearing: UHMWPE
- Wires: 18AWG direct burial shielded cable

Warranty

- Two years



TMR MAINTENANCE REMOTE

FEATURES & BENEFITS

Operates on Unlicensed MURS Frequencies

Up to 1.5 mile line-of-sight range without the hassles of FCC licensing.

Toro Exclusive All Stations Cycle (ASC) Function

Provides one-start system operation for walk-throughs, maximizing productivity – 2-minute runtimes per station.

Quick-Connect System

Allows receiver to easily be moved from one controller to another; circular connector can be bracket-mounted or mounted using 1/2" conduit.

Multi-Controller/Multi-Site Capability

Programmable address allowing selection of up to 999 different remote receivers at controllers.



SPECIFICATIONS

Operational

- Frequency: MURS designated channels – U.S. USE ONLY (151.82, 151.88, 151.94, 154.57, 154.6 MHz)
- Automatic detection and avoidance of busy channels
- Operating temperature range: -14° to 140° F
- Up to 1.5 miles line-of-sight range and typically 1/2 mile in obstructed areas
- Intuitive, easy-to-use keypad
- Large, easy-to-read LCD display
- Remotely controls up to 500 stations
- Battery life indicator
- Circular connector comes standard with 5' cable
- Simple, intuitive command set
- Default run time is 10 minutes
- Display shows countdown of time left to run
- Ergonomic design and removable belt clip

Electrical

- Receiver input voltage: 22-26 Vac input
- Transmitter DC Operating voltage: 4-6V DC
- Transmitter operates on 4 AA batteries
- Receiver operates off of the 24 Vac power from the controller
- FCC, UL-listed

Controller Compatibility

- Toro®: TMC-424E, Custom Command, and TDC

Dimensions

- Receiver size: 12" x 3" with antenna
- Transmitter size: 12" x 3" with antenna

Warranty

- Two years

Specifying Information—TMR Maintenance Remote

TMR-1-XXX	
<i>Model</i>	<i>Description</i>
TMR-1	XXX
TMR-1—Toro Maintenance Remote	KIT—Complete Kit: Transmitter, Receiver, Circular Connector/Cable Assembly, Carrying Case CC—Circular Connector for Receiver
Example: A complete TMR Maintenance Remote Kit would be specified as: TMR-1-KIT	

EVOLUTION® SMART CONNECT® REMOTE

FEATURES & BENEFITS

Compatible with EVOLUTION®

Works with EVOLUTION Series Controllers outfitted with Smart Connect® receivers.

Backlit Display Handheld Remote

Makes maintenance checks easy after sunset with a backlit display.

Additional Features

- ✓ Provide individual zones or schedule ON/OFF schedules
- ✓ Mini USB port for upgrades to features or access to data
- ✓ Water resistant case
- ✓ Battery indicator
- ✓ Set the maximum zone count to match the controller

SPECIFICATIONS

Operational

- Up to 1,000' range line of sight
- Address PIN range 0000-9999
- Watering and auxiliary modes

Electrical

- 9 Vdc Battery

Temperature

- Operating -14°F to 140°F
- Storage -22°F to 149°F

Dimensions

- 7" x 2 3/4" x 1 1/4"

Warranty

- Five years



Specifying Information—Smart Connect® Remote

Model	Description
EVO-HH	Smart Connect Handheld Remote



EICON REMOTE

FEATURES & BENEFITS

Up to 5-Mile Line-of-Sight Range

Plus powerful UHF FM signal is the best available tool for communicating with receivers behind walls or in other hard-to-reach locations.

Universal Wiring

Receivers connect to any controller with 24 VAC outputs.

Two-way Voice Communication

Handheld transmitter is capable of two-way voice communication as well as data transmission.



SPECIFICATIONS

Operational

- Handheld radios feature rechargeable batteries
- Low battery indicators
- Handheld transceivers are locally serviceable at radio service centers
- All components comply with FCC rules and regulations
- Receivers available in 12, 24, 36 or 48 station configurations
- MRC units are compatible with any controller that controls solenoids, relays etc., utilizing 24 VAC
- Any of the outputs in the host controller maybe turned on or off in any order
- A run time can be entered from the handheld transceiver (from 1 to 20 minutes) for multiple valve syringe or sequential operations
- Ability to individually address and control up to 1000 controllers with a single handheld transceiver
- Receiver address codes may be changed by the operator
- An indicator light illuminates and begins blinking when the receiver unit is properly installed
- External antenna connectors are standard. For special applications where reception may become a problem such as deep underground or extreme ranges, special application antennas are available

Optional Accessories

- UHF Handheld Transceiver with DTMF Keypad – includes charger (TRX-5U)
- 30", 12-station wiring harness for wiring to individual station outputs (P-30)
- 48", 12-station wiring harness for wiring to individual station outputs (P-48)
- 36" pigtail extension (E-36)

Dimensions

- MRC Receiver: 6 1/4" D x 8" W x 2 1/2" H

Warranty

- Two years

Specifying Information—EICON Special Build

ESB-XX-XX-XX			
Description	Model	Type	Options
SB	XX	XX	XX
SB—EICON Special Build	MRC—Maintenance Remote Complete Kit MRX—Maintenance Remote Receiver RLM—Permanent Mount Receiver Card	12—12-Stations Universal 24—24-Stations Universal 36—36-Stations Universal 48—48-Stations Universal	RB—Rain Bird® (ESP-MC) Remote Connector*

*Only available in RLM Version. Rain Bird® is a registered trade mark of Rain Bird Corporation.

FEATURES & BENEFITS

Complete Remote Control Kit in a Carrying Case

Includes transmitter, receiver, connector and cable assembly and a user's guide in one convenient, portable case

Operates with All Irritrol® Rain Master® Controllers and Other Manufacturers' 24V AC Controllers (PRO MAX-UA Version Only)

Allows maintenance control for a wide variety of controllers

Up to 1 Mile Range (Line-of-Sight)

Provides operating range for larger projects

Addresses Up to 999 Individual Controllers

Transmits commands to specific controllers even though others are within range in permanent mount applications

Remotely Controls Up to 200 Stations

Permanent mount or portable models available

Quick Connection/Disconnection System

Allows receiver to be easily moved from one controller to another

Plug-and-Play with All Irritrol Rain Master Controllers



The PROMAX-UA Kit Includes:



- Transmitter
- Receiver
- Adapter
- Connector Cables*
- Carrying case
- Antennas

*For any 24V controller up to 32 stations not included in standard Pro Max

SPECIFICATIONS

Operational

PRO MAX Receiver

- Operating frequency: 154.6 MHz
- Sensitivity: 0.4 microvolt typical
- Operating temperature range: 32 to 140 degrees F°
- Storage temperature range: -4 to 158 degrees F°
- Humidity range: 0 to 90% non-condensing

PRO MAX Transmitter

- Operating frequency: 154.6 MHz
- Modulation type: frequency modulation
- Frequency stability: 5%
- Operating temperature range: 32 to 148 degrees F°
- Storage temperature range: -4 to 158 degrees F°
- Humidity range: 0 to 90% non-condensing

Electrical

PRO MAX Receiver

- Power source: 22–32 V AC 50/60 Hz

PRO MAX Transmitter

- Battery: CR-P2 lithium 6V (user replaceable)
- Battery life expectancy: 1 season (typical)

Dimensions

- Transmitter: H: 1½", W: 1¾", D: 3¾"
- Receiver: H: 1½", W: 1", D: 3"

PRO MAX SERIES MODEL LIST

Model	Description
PROMAX	Complete remote kit for Irritrol Rain Master
PROMAX-UA	Complete remote kit for any manufacturer's 24V AC controller



CRR SERIES

FEATURES & BENEFITS

Labor Savings

Makes system testing and maintenance a one person job

Cost Savings

Uses the same transmitter in the Kit for CLIMATE LOGIC WeatherSensing System

Extra Sales Opportunity

Remote kit for contractor's to offer to the end user

"9999" Selectable PIN Codes

Individual PIN addresses reduce "cross talk" and unauthorized activity

Compatible with Four Series of Irritrol® Controllers

The mini-receiver connects to the standard remote ports on 35 models

Programmable for Future Upgrades Over the Internet

Computer connectable handheld allows downloadable features/updates

Works with the Irritrol Climate Logic® Weather Sensing System

Allows remote access through Climate Logic

RANGE UP TO 1,000' (Line-of-Sight)

Adequate for large residential and small to medium commercial irrigation system

Additional Features

- ✓ 9-volt battery powers the handheld
- ✓ The controller powers the remote receiver
- ✓ Provides individual station (zone) ON and OFF command
- ✓ Set maximum station count to match controller
- ✓ "Start Program A, B, or C" capability on some controllers
- ✓ Five-year warranty



CRR SERIES- MODEL LIST

Model	Description
R-100-KIT	Transmitter, receiver and cable adapter
CL-R1	Remote transmitter only
CL-MR	Receiver only
CMR-ADP	Cable adapter only

Specifying Information—CRR Series

CL-XX	
Model	Description
CL	XX
CL - Climate Logic®	R1 - Transmitter MR - Receiver

SPECIFICATIONS

Dimensions

- Transmitter: H: 7", W: 2¾", D:1¼"
- Receiver: H: 5½", W: 23/8", D: 1

Specifying Information—R100 Kit

R100-KIT	
Model	Description
CL	XX
R-100 - Maintenance Remote	KIT - Complete kit



RESOURCES





RESOURCES

Pages 164-191

Formulas & Conversion Factors	166
Drip Equations	167
Sprinkler Spacing & Winterization	168-186
Friction Loss Characteristics	187
Pressure Loss Through Water Meters	188
Wire Sizing	189
Toro Limited Warranty for Irrigation Products	190

FORMULAS AND CONVERSION FACTORS

PRECIPITATION RATES

U.S. (SPACING IN FEET)	METRIC (SPACING IN METERS)
Equilateral Triangular Spacing P.R.= $\frac{\text{GPM of 360} \times 96.25}{(\text{in/hr}) (\text{Head Spacing})^2 \times .866}$	P.R.= $\frac{\text{m}^3/\text{hr of 360} \times 1000}{(\text{mm/hr}) (\text{Head Spacing})^2 \times .866}$
Square/Rectangular Spacing P.R.= $\frac{\text{GPM of 360} \times 96.25}{(\text{in/hr}) \text{Head Spacing} \times \text{Row Spacing}}$	P.R.= $\frac{\text{m}^3/\text{hr of 360} \times 1000}{(\text{mm/hr}) \text{Head Spacing} \times \text{Row Spacing}}$
Square/Rectangular Spacing for Specific Arc P.R.= $\frac{34650 \times \text{GPM (for any arc)}}{(\text{in/hr}) \text{Degrees of Arc} \times \text{Head Spacing} \times \text{Row Spacing}}$	P.R.= $\frac{\text{m}^3/\text{hr (for any arc)} \times 1000}{(\text{mm/hr}) \text{Degrees of Arc} \times \text{Head Spacing} \times \text{Row Spacing}}$
HORSEPOWER H.P. = $\frac{\text{GPM} \times \text{Ft of Head}}{3,960 \times \text{Pump Efficiency (expressed as a decimal)}}$	H.P. = $\frac{\text{LPM} \times \text{Meters of Head}}{3,433 \times \text{Pump Efficiency (expressed as a decimal)}}$
STATION RUN TIME S.R.T. = $\frac{\text{Total Weekly Req'd (inch/wk)} \times 60 \text{ (min/hr)}}{(\text{min/wk}) \text{Precipitation Rate (in/hr)}}$	S.R.T. = $\frac{\text{Total Weekly Req'd (mm/wk)} \times 60 \text{ (min/hr)}}{(\text{min/wk}) \text{Precipitation Rate (mm/hr)}}$
PIPE VELOCITY V= $\frac{0.4085 \times \text{Flow (GPM)}}{(\text{ft/sec}) (\text{Inside Pipe Diameter in Inches})^2}$	V= $\frac{1273.24 \times \text{Flow (l/sec)}}{(\text{m/sec}) (\text{Inside Pipe Diameter in Millimeters})^2}$
SLOPE S = $\frac{\text{Rise (Measure of Length)}}{\text{Run (Measure of Length)}}$	

TO CONVERT	FROM	TO	MULTIPLY BY
Area	acres	feet ²	43,560
	acres	meters ²	4046.8
	meters ²	feet ²	10.764
	feet ²	inches ²	144
	inches ²	centimeters ²	6.452
	hectares	meters ²	10,000
	hectares	acres	2.471
Power	kilowatts	horsepower	1.3410
Flow	feet ³ /minutes	meters ³ /second	0.00047
	feet ³ /second	meters ³ /second	0.02832
	yards ³ /minute	meters ³ /second	0.01274
	gallons/minute	meters ³ /hour	0.22716
	gallons/minute	liters/minute	3.7854
	gallons/minute	liters/second	0.06309
	meters ³ /hour	liters/minute	16.645
	meters ³ /hour	liters/second	0.2774
	liters/minute	liters/second	60
Length	feet	inches	12
	inches	centimeters	2.540
	feet	meters	0.30481
	kilometers	miles	0.6214
	miles	feet	5,280
	miles	meters	1609.34
	millimeters	inch	0.03937

TO CONVERT	FROM	TO	MULTIPLY BY
Pressure	psi	kilopascals	6.89476
	psi	bars	.06895
	bars	kilopascals	100
	psi	feet of head	2.31
Velocity	feet/second	meters/second	.3048
Volume	feet ³	gallons	7.481
	feet ³	liters	28.32
	meters ³	feet ³	35.31
	meters ³	yard ³	1.3087
	yards ³	feet ³	27
	yards ³	gallons	202
	acres/feet	feet ³	43,560
	gallons	meters ³	.003785
gallons	liters	3.785	
imperial gallons	gallons	1.833	

DRIP EQUATIONS

NUMBER OF EMITTERS PER PLANT

$$\text{Emitters per tree} = \frac{\text{canopy area (sq.ft.)} \times 0.75}{\text{wetted area per emitter (sq.ft.)}}$$

Soil Type	WETTED AREA	
	Diameter (ft.)	Area (sq. ft.)
Sand	2 – 3	3 – 7
Sandy Loam	3 – 4.5	7 – 16
Loam	3 – 5	7 – 20
Clay- Loam	4 – 6	13 – 28
Clay	5 – 7	20 – 38

FLOW PER ZONE

$$\text{Flow per zone (gpm)} = \frac{\text{Total number of drippers} \times \text{dripper flow rate (gph)}}{\text{"60 (minutes)"}}$$

PRECIPITATION RATE FOR EVENLY SPACED LATERALS AND EMITTERS

PRECIPITATION RATE FOR DRIP LATERALS (INCHES/HOUR)							
Emitter Flow	Emitter Spacing	Spacing Between Drip Laterals					
		6 in.	12 in.	18 in.	24 in.	30 in.	36 in.
0.53 gph	12 in.	1.62	0.81	0.54	0.40	0.32	0.27
0.53 gph	18 in.	1.08	0.54	0.36	0.27	0.22	0.18
0.53 gph	24 in.	0.81	0.40	0.27	0.20	0.16	0.13
1.02 gph	12 in.	3.11	1.56	1.04	0.78	0.62	0.52
1.02 gph	18 in.	2.07	1.04	0.69	0.52	0.41	0.35
1.02 gph	24 in.	1.56	0.78	0.52	0.39	0.31	0.26

PRECIPITATION RATE FORMULA:

$$\text{Precipitation Rate (in/hr.)} = \frac{231.1 \times \text{Emitter Flow (gph)}}{\text{Lateral Spacing ("in.")} \times \text{Emitter Spacing (in.)}}$$

Note: This formula applies to evenly spaced drip irrigation laterals and emitters.

PRECIPITATION RATE FOR A SINGLE LATERAL

PRECIPITATION RATE (IN/HR) OF A SINGLE ROW OF DRIPLINE IN A CONTAINED LANDSCAPE						
Emitter Flow	Emitter Spacing	Width of Contained Landscape				
		1 ft.	2 ft.	3 ft.	4 ft.	5 ft.
0.53 gph	12 in.	0.81	0.40	0.27	0.20	0.16
0.53 gph	18 in.	0.54	0.27	0.18	0.13	0.11
0.53 gph	24 in.	0.40	0.20	0.13	0.10	0.08
1.02 gph	12 in.	1.56	0.78	0.52	0.39	0.31
1.02 gph	18 in.	1.04	0.52	0.35	0.26	0.21
1.02 gph	24 in.	0.78	0.39	0.26	0.19	0.16

THERMAL EFFECTS ON DRIP HOSE AND DRIPLINE

For recurring, ambient temperatures above 73°F (23°C), multiply PSI rating of selected tubing by the appropriate FACTOR from the table to the right. Result will be the temp-corrected maximum PSI rating for the tubing selected. For temperatures not shown, but between 73°F & 140°F (23°C & 60°C), interpolate to obtain the temp-corrected maximum PSI rating for the tubing selected. Use this information to select the appropriate pressure regulator to assure tubing life expectancy and warranty coverage.

°F	°C	FACTOR
73°	23°	1.00
80°	27°	0.92
90°	32°	0.81
100°	38°	0.70
110°	43°	0.60
120°	49°	0.45
130°	54°	0.32
140°	60°	0.18

BELOW GRADE DRIP HOSE & DRIPLINE INSTALLATIONS

When installing Blue Stripe® drip hose below grade, consult ANSI/ASAE S376.2: Design, Installation and Performance of Underground, Thermoplastic Irrigation Pipelines for installation protocols regarding trench conditions, water packing of the drip hose prior to backfill and the quality of backfill material. Failure to follow these installation protocols will shorten the life of the tubing and may void the warranty.

SPRINKLER SPACING & WINTERIZATION SPECIFICATIONS

The Toro Company does not recommend designing for 0 mph wind conditions. Design in consideration of the worst wind conditions.

PRECIPITATION RATE FORMULAS

Square-spaced sprinklers in pattern:

$$\frac{96.3 \times \text{gpm applied to irrigated area}}{(\text{Spacing between sprinklers})^2}$$

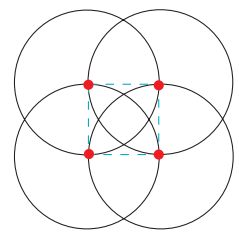

Triangular-spaced sprinklers in pattern:

$$\frac{\text{gpm of full circle} \times 96.3}{(\text{Spacing between sprinklers})^2 \times 0.866}$$

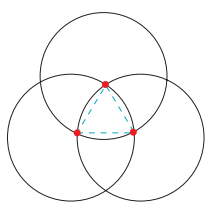

Single row:

$$\frac{\text{gpm of full circle} \times 96.3}{(\text{Spacing}) (\text{Scallop})}$$

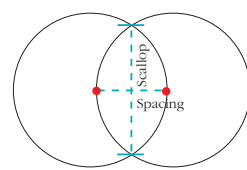

Area and flow:

$$\frac{\text{Total gpm of zone} \times 96.3}{\text{Total irrigated square feet of zone}}$$

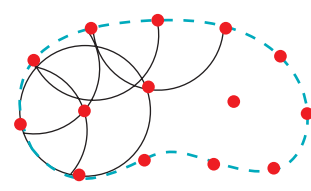

WINTERIZATION SPECIFICATIONS
In freezing climates, sprinklers and valves should be properly winterized to prevent freeze-related damage.

FRICITION LOSS FORMULAS

Hazen-Williams Equation:

$$H_f = (0.2083) (100 / C)^{1.852} (Q^{1.852} / D^{4.866})$$

(The result is multiplied by .433 to give psi loss for 100 feet of pipe)

The Velocity Values were Derived Using the Following:

$$V = (0.408 \times Q_{\text{gpm}}) / d^2$$

(The average inside diameter of OD controlled pipe was based upon subtracting two times the minimum wall thickness plus one-half of the wall thickness tolerance from the outside diameter.)

- Pressure ratings for plastic pipes are based on 23° C or 73.4° F
- Head loss decreases (increases) approximately 1% for every 3 degrees F above (below) the reference temperature (73.4° F)

FRICTION LOSS CHARACTERISTICS

LOSSES IN PSI PER 100 FEET OF HOSE (PSI/100 FT.) FOR HOSE SIZES: .596" (16MM) ID THROUGH .870" (22MM) ID

Part No.		EHO1650		EHO2055		EHO2060		HDO2255	
Nom. ID		0.600"		0.830"		0.820"		0.870"	
Min. ID		0.596"		0.821"		0.811"		0.870"	
Nom. Wall		0.050"		0.055"		0.060"		0.055"	
Flow		Velocity	Loss	Velocity	Loss	Velocity	Loss	Velocity	Loss
GPM	GPH	FPS	PSI	FPS	PSI	FPS	PSI	FPS	PSI
0.5	30	0.58	0.17	0.30	0.03	0.31	0.04	0.27	0.03
1.0	60	1.15	0.60	0.61	0.13	0.62	0.13	0.54	0.10
1.5	90	1.73	1.27	0.91	0.27	0.93	0.28	0.81	0.20
2.0	120	2.30	2.16	1.21	0.46	1.24	0.48	1.08	0.34
2.5	150	2.88	3.27	1.52	0.69	1.55	0.73	1.35	0.52
3.0	180	3.45	4.59	1.82	0.96	1.86	1.02	1.62	0.73
3.5	210	4.03	6.10	2.12	1.28	2.17	1.36	1.89	0.97
4.0	240	4.60	7.82	2.42	1.64	2.48	1.74	2.16	1.24
4.5	270	5.18	9.72	2.73	2.04	2.79	2.17	2.43	1.54
5.0	300	5.75	11.81	3.03	2.48	3.11	2.64	2.70	1.87
6.0	360	6.90	16.56	3.64	3.48	3.73	3.69	3.24	2.62
7.0	420	8.05	22.03	4.24	4.63	4.35	4.92	3.78	3.49
8.0	480	9.20	28.21	4.85	5.93	4.97	6.29	4.32	4.47
9.0	540	10.35	35.09	5.45	7.38	5.59	7.83	4.86	5.56
10.0	600	11.50	42.65	6.06	8.96	6.21	9.52	5.40	6.76
11.0	660	12.65	50.89	6.67	10.70	6.83	11.35	5.94	8.06
12.0	720	13.80	59.78	7.27	12.57	7.45	13.34	6.48	9.47
13.0	780			7.88	14.57	8.07	15.47	7.02	10.99
14.0	840			8.48	16.72	8.70	17.75	7.56	12.61
15.0	900			9.09	19.00	9.32	20.16	8.10	14.32
16.0	960			9.70	21.41	9.94	22.72	8.64	16.14
17.0	1,020			10.30	23.95	10.56	25.42	9.17	18.06
18.0	1,080			10.91	26.63	11.18	28.26	9.71	20.08
19.0	1,140			11.51	29.43	11.80	31.24	10.25	22.19
20.0	1,200			12.12	32.36	12.42	34.35	10.79	24.40
22.0	1,320			13.33	38.61	13.66	40.98	11.87	29.11
24.0	1,440			14.55	45.36	14.91	48.15	12.95	34.20
26.0	1,560			15.76	52.61	16.15	55.84	14.03	39.67
28.0	1,680			16.97	60.35			15.11	45.51
30.0	1,800							16.19	51.71
32.0	1,920							17.27	58.27

Friction losses are calculated using Hazen-Williams equation (C = 140) and minimum inside diameter. See page 166 for friction loss formulas.

Shaded area represents velocities over 5 fps. Use with caution.

FRICITION LOSS CHARACTERISTICS

POLYETHYLENE (PE) PLASTIC PIPE ID CONTROLLED

Size: ½" thru 4" Flow: 1 thru 500GPM

PE 3408 ASTM D-2239 C=140 PSI LOSS PER 100 FEET OF PIPE (PSI/100 FT)

Size	½"		¾"		1"		1¼"		1½"		2"		2½"		3"		4"	
Avg ID	0.622		0.824		1.049		1.380		1.610		2.067		2.469		3.068		4.026	
Flow GPM	Velocity FPS	PSI Loss	Velocity FPS	PSI Loss	Velocity FPS	PSI Loss	Velocity FPS	PSI Loss	Velocity FPS	PSI Loss	Velocity FPS	PSI Loss	Velocity FPS	PSI Loss	Velocity FPS	PSI Loss	Velocity FPS	PSI Loss
1	1.05	0.49	0.60	0.12	0.37	0.04	0.21	0.01	0.16	0.00								
2	2.11	1.76	1.20	0.45	0.74	0.14	0.43	0.04	0.31	0.02	0.19	0.01						
3	3.16	3.73	1.80	0.95	1.11	0.29	0.64	0.08	0.47	0.04	0.29	0.01						
4	4.22	6.35	2.40	1.62	1.48	0.50	0.86	0.13	0.63	0.06	0.38	0.02	0.27	0.01				
5	5.27	9.60	3.00	2.44	1.85	0.76	1.07	0.20	0.79	0.09	0.48	0.03	0.33	0.01				
6	6.33	13.46	3.61	3.43	2.22	1.06	1.29	0.28	0.94	0.13	0.57	0.04	0.40	0.02	0.26	0.01		
7	7.38	17.91	4.21	4.56	2.60	1.41	1.50	0.37	1.10	0.18	0.67	0.05	0.47	0.02	0.30	0.01		
8	8.44	22.93	4.81	5.84	2.97	1.80	1.71	0.47	1.26	0.22	0.76	0.07	0.54	0.03	0.35	0.01		
9	9.49	28.52	5.41	7.26	3.34	2.24	1.93	0.59	1.42	0.28	0.86	0.08	0.60	0.03	0.39	0.01		
10	10.55	34.67	6.01	8.82	3.71	2.73	2.14	0.72	1.57	0.34	0.95	0.10	0.67	0.04	0.43	0.01		
12			7.21	12.37	4.45	3.82	2.57	1.01	1.89	0.48	1.15	0.14	0.80	0.06	0.52	0.02		
14			8.41	16.45	5.19	5.08	3.00	1.34	2.20	0.63	1.34	0.19	0.94	0.08	0.61	0.03		
16			9.61	21.07	5.93	6.51	3.43	1.71	2.52	0.81	1.53	0.24	1.07	0.10	0.69	0.04	0.40	0.01
18			10.82	26.21	6.67	8.10	3.86	2.13	2.83	1.01	1.72	0.30	1.20	0.13	0.78	0.04	0.45	0.01
20			12.02	31.85	7.42	9.84	4.28	2.59	3.15	1.22	1.91	0.36	1.34	0.15	0.87	0.05	0.50	0.01
22					8.16	11.74	4.71	3.09	3.46	1.46	2.10	0.43	1.47	0.18	0.95	0.06	0.55	0.02
24					8.90	13.79	5.14	3.63	3.78	1.72	2.29	0.51	1.61	0.21	1.04	0.07	0.60	0.02
26					9.64	16.00	5.57	4.21	4.09	1.99	2.48	0.59	1.74	0.25	1.13	0.09	0.65	0.02
28					10.38	18.35	6.00	4.83	4.41	2.28	2.67	0.68	1.87	0.28	1.21	0.10	0.70	0.03
30					11.12	20.85	6.43	5.49	4.72	2.59	2.86	0.77	2.01	0.32	1.30	0.11	0.76	0.03
32					11.86	23.50	6.86	6.19	5.04	2.92	3.06	0.87	2.14	0.36	1.39	0.13	0.81	0.03
34					12.61	26.29	7.28	6.92	5.35	3.27	3.25	0.97	2.28	0.41	1.47	0.14	0.86	0.04
36							7.71	7.69	5.67	3.63	3.44	1.08	2.41	0.45	1.56	0.16	0.91	0.04
38							8.14	8.50	5.98	4.02	3.63	1.19	2.54	0.50	1.65	0.17	0.96	0.05
40							8.57	9.35	6.30	4.42	3.82	1.31	2.68	0.55	1.73	0.19	1.01	0.05
42							9.00	10.24	6.61	4.83	4.01	1.43	2.81	0.60	1.82	0.21	1.06	0.06
44							9.43	11.16	6.93	5.27	4.20	1.56	2.94	0.66	1.91	0.23	1.11	0.06
46							9.86	12.12	7.24	5.72	4.39	1.70	3.08	0.71	1.99	0.25	1.16	0.07
48							10.28	13.11	7.56	6.19	4.58	1.84	3.21	0.77	2.08	0.27	1.21	0.07
50							10.71	14.14	7.87	6.68	4.77	1.98	3.35	0.83	2.17	0.29	1.26	0.08
55							11.78	16.87	8.66	7.97	5.25	2.36	3.68	0.99	2.38	0.35	1.38	0.09
60							12.85	19.82	9.44	9.36	5.73	2.77	4.02	1.17	2.60	0.41	1.51	0.11
65									10.23	10.86	6.21	3.22	4.35	1.36	2.82	0.47	1.64	0.13
70									11.02	12.45	6.68	3.69	4.69	1.55	3.03	0.54	1.76	0.14
75									11.81	14.15	7.16	4.19	5.02	1.77	3.25	0.61	1.89	0.16
80									12.59	15.95	7.64	4.73	5.35	1.99	3.47	0.69	2.01	0.18
85									13.38	17.84	8.12	5.29	5.69	2.23	3.68	0.77	2.14	0.21
90											8.59	5.88	6.02	2.48	3.90	0.86	2.27	0.23
95											9.07	6.50	6.36	2.74	4.12	0.95	2.39	0.25
100											9.55	7.15	6.69	3.01	4.33	1.05	2.52	0.28
110											10.50	8.53	7.36	3.59	4.77	1.25	2.77	0.33
120											11.46	10.02	8.03	4.22	5.20	1.47	3.02	0.39
130											12.41	11.62	8.70	4.89	5.63	1.70	3.27	0.45
140											13.37	13.33	9.37	5.61	6.07	1.95	3.52	0.52
150													10.04	6.38	6.50	2.22	3.78	0.59
160													10.71	7.19	6.94	2.50	4.03	0.67
170													11.38	8.04	7.37	2.79	4.28	0.74
180													12.05	8.94	7.80	3.11	4.53	0.83
190													12.72	9.88	8.24	3.43	4.78	0.92
200													13.39	10.87	8.67	3.78	5.03	1.01
220															9.54	4.50	5.54	1.20
240															10.40	5.29	6.04	1.41
260															11.27	6.14	6.54	1.64
280															12.14	7.04	7.05	1.88
300															13.00	8.00	7.55	2.13
320															13.87	9.02	8.05	2.40
340																	8.56	2.69
360																	9.06	2.99
380																	9.57	3.30
400																	10.07	3.63
420																	10.57	3.98
440																	11.08	4.33
460																	11.58	4.71
480																	12.08	5.09
500																	12.59	5.49

See page 166 for friction loss formulas.

FRICITION LOSS CHARACTERISTICS

PVC CLASS 160 IPS PLASTIC PIPE

Size: ½" thru 6" Flow: 1 thru 500GPM

ASTM D-2241 (1120, 1220) SDR 26 C=150 PSI LOSS PER 100 FEET OF PIPE (PSI/100 FT)

size	1"		1¼"		1½"		2"		2½"		3"		4"		6"						
Avg.ID	1.175		1.512		1.734		2.173		2.635		3.210		4.134		6.084						
Pipe OD	1.315		1.660		1.900		2.375		2.875		3.500		4.500		6.625						
Avg Wall	0.070		0.074		0.083		0.101		0.120		0.145		0.183		0.271						
MinWall	0.060		0.064		0.073		0.091		0.110		0.135		0.173		0.255						
Flow GPM	Velocity FPS	PSI Loss	Velocity FPS	PSI Loss	Velocity FPS	PSI Loss	Velocity FPS	PSI Loss	Velocity FPS	PSI Loss	Velocity FPS	PSI Loss	Velocity FPS	PSI Loss	Velocity FPS	PSI Loss					
1	0.30	0.02	0.18	0.01	0.14	0.00															
2	0.59	0.07	0.36	0.02	0.27	0.01	0.17	0.00													
3	0.89	0.15	0.54	0.04	0.41	0.02	0.26	0.01													
4	1.18	0.25	0.71	0.07	0.54	0.04	0.35	0.01	0.24	0.00											
5	1.48	0.38	0.89	0.11	0.68	0.06	0.43	0.02	0.29	0.01											
6	1.77	0.54	1.07	0.16	0.81	0.08	0.52	0.03	0.35	0.01	0.24	0.00									
7	2.07	0.71	1.25	0.21	0.95	0.11	0.60	0.04	0.41	0.01	0.28	0.01									
8	2.36	0.91	1.43	0.27	1.09	0.14	0.69	0.05	0.47	0.02	0.32	0.01									
9	2.66	1.14	1.61	0.33	1.22	0.17	0.78	0.06	0.53	0.02	0.36	0.01									
10	2.96	1.38	1.78	0.40	1.36	0.21	0.86	0.07	0.59	0.03	0.40	0.01									
12	3.55	1.94	2.14	0.57	1.63	0.29	1.04	0.10	0.71	0.04	0.48	0.01									
14	4.14	2.58	2.50	0.76	1.90	0.39	1.21	0.13	0.82	0.05	0.55	0.02									
16	4.73	3.30	2.86	0.97	2.17	0.50	1.38	0.17	0.94	0.06	0.63	0.02	0.38	0.01							
18	5.32	4.10	3.21	1.20	2.44	0.62	1.56	0.21	1.06	0.08	0.71	0.03	0.43	0.01							
20	5.91	4.99	3.57	1.46	2.71	0.75	1.73	0.25	1.18	0.10	0.79	0.04	0.48	0.01							
22	6.50	5.95	3.93	1.74	2.99	0.90	1.90	0.30	1.29	0.12	0.87	0.04	0.53	0.01							
24	7.09	6.99	4.28	2.05	3.26	1.05	2.07	0.35	1.41	0.14	0.95	0.05	0.57	0.02							
26	7.68	8.11	4.64	2.38	3.53	1.22	2.25	0.41	1.53	0.16	1.03	0.06	0.62	0.02							
28	8.27	9.30	5.00	2.73	3.80	1.40	2.42	0.47	1.65	0.18	1.11	0.07	0.67	0.02							
30	8.87	10.57	5.35	3.10	4.07	1.59	2.59	0.53	1.76	0.21	1.19	0.08	0.72	0.02							
32	9.46	11.91	5.71	3.49	4.34	1.79	2.76	0.60	1.88	0.23	1.27	0.09	0.76	0.03	0.35	0.00					
34	10.05	13.32	6.07	3.91	4.61	2.01	2.94	0.67	2.00	0.26	1.35	0.10	0.81	0.03	0.37	0.00					
36	10.64	14.81	6.42	4.34	4.88	2.23	3.11	0.74	2.12	0.29	1.43	0.11	0.86	0.03	0.40	0.00					
38	11.23	16.37	6.78	4.80	5.16	2.46	3.28	0.82	2.23	0.32	1.50	0.12	0.91	0.04	0.42	0.01					
40	11.82	18.00	7.14	5.28	5.43	2.71	3.46	0.90	2.35	0.35	1.58	0.14	0.95	0.04	0.44	0.01					
42	12.41	19.70	7.50	5.78	5.70	2.97	3.63	0.99	2.47	0.39	1.66	0.15	1.00	0.04	0.46	0.01					
44	13.00	21.47	7.85	6.30	5.97	3.23	3.80	1.08	2.59	0.42	1.74	0.16	1.05	0.05	0.48	0.01					
46	13.59	23.32	8.21	6.84	6.24	3.51	3.97	1.17	2.70	0.46	1.82	0.18	1.10	0.05	0.51	0.01					
48	14.18	25.23	8.57	7.40	6.51	3.80	4.15	1.27	2.82	0.50	1.90	0.19	1.15	0.06	0.53	0.01					
50	14.78	27.21	8.92	7.98	6.78	4.10	4.32	1.37	2.94	0.53	1.98	0.20	1.19	0.06	0.55	0.01					
55			9.82	9.52	7.46	4.89	4.75	1.63	3.23	0.64	2.18	0.24	1.31	0.07	0.61	0.01					
60			10.71	11.18	8.14	5.74	5.18	1.91	3.53	0.75	2.38	0.29	1.43	0.08	0.66	0.01					
65			11.60	12.97	8.82	6.66	5.62	2.22	3.82	0.87	2.57	0.33	1.55	0.10	0.72	0.01					
70			12.49	14.88	9.50	7.64	6.05	2.55	4.11	1.00	2.77	0.38	1.67	0.11	0.77	0.02					
75			13.38	16.90	10.18	8.68	6.48	2.89	4.41	1.13	2.97	0.43	1.79	0.13	0.83	0.02					
80			14.28	19.05	10.86	9.78	6.91	3.26	4.70	1.28	3.17	0.49	1.91	0.14	0.88	0.02					
85					11.53	10.94	7.34	3.65	4.99	1.43	3.37	0.55	2.03	0.16	0.94	0.02					
90					12.21	12.16	7.78	4.06	5.29	1.59	3.56	0.61	2.15	0.18	0.99	0.03					
95					12.89	13.45	8.21	4.48	5.58	1.76	3.76	0.67	2.27	0.20	1.05	0.03					
100					13.57	14.79	8.64	4.93	5.88	1.93	3.96	0.74	2.39	0.22	1.10	0.03					
110					14.93	17.64	9.50	5.88	6.46	2.30	4.36	0.88	2.63	0.26	1.21	0.04					
120							10.37	6.91	7.05	2.71	4.75	1.04	2.86	0.30	1.32	0.05					
130							11.23	8.02	7.64	3.14	5.15	1.20	3.10	0.35	1.43	0.05					
140							12.10	9.20	8.23	3.60	5.54	1.38	3.34	0.40	1.54	0.06					
150							12.96	10.45	8.81	4.09	5.94	1.57	3.58	0.46	1.65	0.07					
160							13.82	11.77	9.40	4.61	6.34	1.76	3.82	0.52	1.76	0.08					
170							14.69	13.17	9.99	5.16	6.73	1.97	4.06	0.58	1.87	0.09					
180									10.58	5.73	7.13	2.19	4.30	0.64	1.98	0.10					
190									11.16	6.34	7.52	2.42	4.54	0.71	2.09	0.11					
200									11.75	6.97	7.92	2.67	4.77	0.78	2.20	0.12					
220			Shaded area represents velocities over 5 Feet Per Second (FPS). Use with caution.								12.93	8.31	8.71	3.18	5.25	0.93	2.42	0.14			
240														14.10	9.77	9.50	3.74	5.73	1.09	2.65	0.17
260																10.29	4.33	6.21	1.27	2.87	0.19
280																11.09	4.97	6.68	1.45	3.09	0.22
300																11.88	5.65	7.16	1.65	3.31	0.25
320											12.67	6.37	7.64	1.86	3.53	0.28					
340											13.46	7.12	8.12	2.08	3.75	0.32					
360											14.25	7.92	8.59	2.31	3.97	0.35					
380													9.07	2.56	4.19	0.39					
400													9.55	2.81	4.41	0.43					
420													10.30	3.08	4.63	0.47					
440													10.50	3.35	4.85	0.51					
460													10.98	3.64	5.07	0.56					
480													11.46	3.94	5.29	0.60					
500													11.94	4.25	5.51	0.65					

See page 166 for friction loss formulas.

FRICITION LOSS CHARACTERISTICS

SCHEDULE 40 PVC IPS PLASTIC PIPE

Size: 4" thru 12" Flow: 10 thru 3000GPM
 ASTM D1785 C=150 PSI LOSS PER 100 FEET OF PIPE (PSI/100 FT)

size	4"		6"		8"		10"		12"	
Avg.ID	3.998		6.031		7.942		9.976		11.889	
Pipe OD	4.500		6.625		8.625		10.750		12.750	
Avg Wall	0.251		0.297		0.342		0.387		0.431	
Min Wall	0.237		0.280		0.322		0.365		0.406	
Flow GPM	Velocity FPS	PSI Loss	Velocity FPS	PSI Loss	Velocity FPS	PSI Loss	Velocity FPS	PSI Loss	Velocity FPS	PSI Loss
10	0.26	0.00	0.11	0.00	0.06	0.00	0.04	0.00	0.03	0.00
20	0.51	0.01	0.22	0.00	0.13	0.00	0.08	0.00	0.06	0.00
30	0.77	0.03	0.34	0.00	0.19	0.00	0.12	0.00	0.09	0.00
40	1.02	0.05	0.45	0.01	0.26	0.00	0.16	0.00	0.12	0.00
50	1.28	0.07	0.56	0.01	0.32	0.00	0.20	0.00	0.14	0.00
60	1.53	0.10	0.67	0.01	0.39	0.00	0.25	0.00	0.17	0.00
70	1.79	0.13	0.79	0.02	0.45	0.00	0.29	0.00	0.20	0.00
80	2.04	0.17	0.90	0.02	0.52	0.01	0.33	0.00	0.23	0.00
90	2.30	0.21	1.01	0.03	0.58	0.01	0.37	0.00	0.26	0.00
100	2.55	0.25	1.12	0.03	0.65	0.01	0.41	0.00	0.29	0.00
120	3.06	0.36	1.35	0.05	0.78	0.01	0.49	0.00	0.35	0.00
140	3.57	0.47	1.57	0.06	0.91	0.02	0.57	0.01	0.40	0.00
160	4.08	0.61	1.79	0.08	1.03	0.02	0.66	0.01	0.46	0.00
180	4.59	0.75	2.02	0.10	1.16	0.03	0.74	0.01	0.52	0.00
200	5.11	0.92	2.24	0.12	1.29	0.03	0.82	0.01	0.58	0.00
225	5.74	1.14	2.52	0.15	1.46	0.04	0.92	0.01	0.65	0.01
250	6.38	1.39	2.80	0.19	1.62	0.05	1.02	0.02	0.72	0.01
275	7.02	1.65	3.08	0.22	1.78	0.06	1.13	0.02	0.79	0.01
300	7.66	1.94	3.37	0.26	1.94	0.07	1.23	0.02	0.87	0.01
325	8.30	2.25	3.65	0.30	2.10	0.08	1.33	0.03	0.94	0.01
350	8.93	2.58	3.93	0.35	2.26	0.09	1.43	0.03	1.01	0.01
375			4.21	0.40	2.43	0.10	1.54	0.03	1.08	0.01
400			4.49	0.45	2.59	0.12	1.64	0.04	1.15	0.02
425			4.77	0.50	2.75	0.13	1.74	0.04	1.23	0.02
450			5.05	0.56	2.91	0.15	1.84	0.05	1.30	0.02
475			5.33	0.62	3.07	0.16	1.95	0.05	1.37	0.02
500			5.61	0.68	3.23	0.18	2.05	0.06	1.44	0.02
550			6.17	0.81	3.56	0.21	2.25	0.07	1.59	0.03
600			6.73	0.95	3.88	0.25	2.46	0.08	1.73	0.03
650			7.29	1.10	4.20	0.29	2.66	0.09	1.88	0.04
700			7.85	1.26	4.53	0.33	2.87	0.11	2.02	0.05
750					4.85	0.38	3.07	0.12	2.16	0.05
800					5.17	0.42	3.28	0.14	2.31	0.06
850					5.50	0.47	3.48	0.16	2.45	0.07
900					5.82	0.53	3.69	0.17	2.60	0.07
950					6.15	0.58	3.89	0.19	2.74	0.08
1000					6.47	0.64	4.10	0.21	2.89	0.09
1050					6.79	0.70	4.30	0.23	3.03	0.10
1150					7.44	0.83	4.71	0.27	3.32	0.12
1200					7.76	0.90	4.92	0.30	3.46	0.13
1250							5.12	0.32	3.61	0.14
1300							5.33	0.34	3.75	0.15
1350							5.53	0.37	3.90	0.16
1400							5.74	0.39	4.04	0.17
1500							6.15	0.45	4.33	0.19
1550							6.35	0.47	4.47	0.20
1600							6.56	0.50	4.62	0.21
1650							6.76	0.53	4.76	0.23
1700							6.97	0.56	4.91	0.24
1750							7.17	0.59	5.05	0.25
1800									5.20	0.27
1850									5.34	0.28
1900									5.48	0.29
1950									5.63	0.31
2000									5.77	0.32
2100									6.06	0.35
2200									6.35	0.39
2300									6.64	0.42
2400									6.93	0.45
2500									7.22	0.49
2600										
2700										
2800										
2900										
3000										

Shaded area represents velocities over 5 fps.
Use with caution.

See page 166 for friction loss formulas.

FRICION LOSS CHARACTERISTICS

SCHEDULE 80 PVC IPS PLASTIC PIPE

Size: 4" thru 12" Flow: 10 thru 3000GPM

ASTM D1785 C=150 PSI LOSS PER 100 FEET OF PIPE (PSI/100 FT)

size	4"		6"		8"		10"		12"	
Avg.ID	3.786		5.709		7.565		9.493		11.294	
Pipe OD	4.500		6.625		8.625		10.750		12.750	
Avg Wall	0.357		0.458		0.530		0.629		0.728	
Min Wall	0.337		0.432		0.500		0.593		0.687	
Flow GPM	Velocity FPS	PSI Loss	Velocity FPS	PSI Loss	Velocity FPS	PSI Loss	Velocity FPS	PSI Loss	Velocity FPS	PSI Loss
10	0.28	0.00	0.13	0.00	0.07	0.00	0.05	0.00	0.03	0.00
20	0.57	0.02	0.25	0.00	0.14	0.00	0.09	0.00	0.06	0.00
30	0.85	0.04	0.38	0.00	0.21	0.00	0.14	0.00	0.10	0.00
40	1.14	0.06	0.50	0.01	0.29	0.00	0.18	0.00	0.13	0.00
50	1.42	0.09	0.63	0.01	0.36	0.00	0.23	0.00	0.16	0.00
60	1.71	0.13	0.75	0.02	0.43	0.00	0.27	0.00	0.19	0.00
70	1.99	0.17	0.88	0.02	0.50	0.01	0.32	0.00	0.22	0.00
80	2.28	0.22	1.00	0.03	0.57	0.01	0.36	0.00	0.26	0.00
90	2.56	0.27	1.13	0.04	0.64	0.01	0.41	0.00	0.29	0.00
100	2.85	0.33	1.25	0.04	0.71	0.01	0.45	0.00	0.32	0.00
120	3.42	0.46	1.50	0.06	0.86	0.02	0.54	0.01	0.38	0.00
140	3.98	0.62	1.75	0.08	1.00	0.02	0.63	0.01	0.45	0.00
160	4.55	0.79	2.00	0.11	1.14	0.03	0.72	0.01	0.51	0.00
180	5.12	0.98	2.25	0.13	1.28	0.03	0.81	0.01	0.58	0.00
200	5.69	1.19	2.50	0.16	1.43	0.04	0.91	0.01	0.64	0.01
225	6.40	1.49	2.82	0.20	1.60	0.05	1.02	0.02	0.72	0.01
250	7.12	1.81	3.13	0.24	1.78	0.06	1.13	0.02	0.80	0.01
275	7.83	2.15	3.44	0.29	1.96	0.07	1.25	0.02	0.88	0.01
300	8.54	2.53	3.76	0.34	2.14	0.09	1.36	0.03	0.96	0.01
325	9.25	2.94	4.07	0.40	2.32	0.10	1.47	0.03	1.04	0.01
350	9.96	3.37	4.38	0.46	2.50	0.12	1.58	0.04	1.12	0.02
375			4.69	0.52	2.67	0.13	1.70	0.04	1.20	0.02
400			5.01	0.58	2.85	0.15	1.81	0.05	1.28	0.02
425			5.32	0.65	3.03	0.17	1.92	0.06	1.36	0.02
450			5.63	0.73	3.21	0.18	2.04	0.06	1.44	0.03
475			5.95	0.80	3.39	0.20	2.15	0.07	1.52	0.03
500			6.26	0.88	3.56	0.22	2.26	0.07	1.60	0.03
550			6.88	1.05	3.92	0.27	2.49	0.09	1.76	0.04
600			7.51	1.24	4.28	0.31	2.72	0.10	1.92	0.04
650			8.14	1.44	4.63	0.36	2.94	0.12	2.08	0.05
700			8.76	1.65	4.99	0.42	3.17	0.14	2.24	0.06
750					5.35	0.48	3.40	0.16	2.40	0.07
800					5.70	0.54	3.62	0.18	2.56	0.08
850					6.06	0.60	3.85	0.20	2.72	0.09
900					6.42	0.67	4.07	0.22	2.88	0.09
950					6.77	0.74	4.30	0.24	3.04	0.10
1000					7.13	0.81	4.53	0.27	3.20	0.12
1050					7.49	0.89	4.75	0.29	3.36	0.13
1150					8.20	1.05	5.21	0.35	3.68	0.15
1200					8.56	1.14	5.43	0.38	3.84	0.16
1250							5.66	0.41	4.00	0.17
1300							5.89	0.44	4.16	0.19
1350							6.11	0.47	4.32	0.20
1400							6.34	0.50	4.48	0.22
1500							6.79	0.57	4.80	0.24
1550							7.02	0.60	4.96	0.26
1600							7.24	0.64	5.12	0.28
1650							7.47	0.68	5.28	0.29
1700							7.70	0.72	5.44	0.31
1750							7.92	0.76	5.60	0.33
1800									5.76	0.34
1850									5.92	0.36
1900									6.08	0.38
1950									6.24	0.40
2000									6.40	0.42
2100									6.72	0.46
2200									7.04	0.50
2300									7.36	0.54
2400									7.68	0.58
2500									8.00	0.63
2600										
2700										
2800										
2900										
3000										

Shaded area represents velocities over 5 fps. Use with caution.

See page 166 for friction loss formulas.

FRICTION LOSS CHARACTERISTICS

TYPE 'K' COPPER TUBING

Size: 1/2" thru 3" Flow: 1 thru 600 GPM

ASTM B 88 C=140 PSI LOSS PER 100 FEET OF PIPE (PSI/100 FT)

size	1/2"	5/8"	3/4"	1"	1 1/4"	1 1/2"	2"	2 1/2"	3"					
Avg ID	0.527	0.652	0.745	0.995	1.245	1.481	1.959	2.435	2.907					
Pipe OD	0.625	0.750	0.875	1.125	1.375	1.625	2.125	2.625	3.125					
Avg Wall	0.049	0.049	0.065	0.065	0.065	0.072	0.083	0.095	0.109					
Flow GPM	Velocity FPS	PSI Loss	Velocity FPS	PSI Loss	Velocity FPS	PSI Loss	Velocity FPS	PSI Loss	Velocity FPS	PSI Loss				
1	1.47	1.09	0.96	0.39	0.74	0.20	0.41	0.05	0.26	0.02				
2	2.94	3.94	1.92	1.40	1.47	0.73	0.82	0.18	0.53	0.06				
3	4.41	8.35	2.88	2.97	2.21	1.55	1.24	0.38	0.79	0.13				
4	5.88	14.23	3.84	5.05	2.94	2.64	1.65	0.65	1.05	0.22				
5	7.35	21.51	4.80	7.64	3.68	3.99	2.06	0.98	1.32	0.33				
6	8.81	30.15	5.76	10.70	4.41	5.59	2.47	1.37	1.58	0.46				
7	10.28	40.12	6.72	14.24	5.15	7.44	2.88	1.82	1.84	0.61				
8	11.75	51.37	7.68	18.24	5.88	9.53	3.30	2.33	2.11	0.78				
9	13.22	63.90	8.64	22.68	6.62	11.85	3.71	2.90	2.37	0.97				
10	14.69	77.66	9.60	27.57	7.35	14.41	4.12	3.52	2.63	1.18				
12			11.52	38.64	8.82	20.20	4.95	4.94	3.16	1.66				
14			13.44	51.41	10.29	26.87	5.77	6.57	3.69	2.21				
16			15.36	65.83	11.76	34.41	6.59	8.42	4.21	2.83				
18			17.28	81.88	13.23	42.80	7.42	10.47	4.74	3.52				
20					14.70	52.02	8.24	12.72	5.26	4.28				
22					16.17	62.06	9.07	15.18	5.79	5.10				
24					17.64	72.91	9.89	17.84	6.32	5.99				
26							10.71	20.69	6.84	6.95				
28							11.54	23.73	7.37	7.97				
30							12.36	26.96	7.90	9.06				
32							13.19	30.39	8.42	10.21				
34							14.01	34.00	8.95	11.42				
36							14.84	37.79	9.48	12.70				
38							15.66	41.77	10.00	14.04				
40							16.48	45.94	10.53	15.43				
42							17.31	50.28	11.06	16.89				
44									11.58	18.41				
46									12.11	19.99				
48									12.63	21.63				
50									13.16	23.33				
55									14.48	27.84				
60									15.79	32.70				
65									17.11	37.93				
70									18.43	43.51				
75									13.95	21.24				
80									14.88	23.94				
85									15.81	26.79				
90									16.74	29.78				
95									17.67	32.91				
100									18.60	36.19				
110			Shaded area represents velocities over 7 fps. Use with caution, where water hammer is a concern.								11.69	11.07		
120													12.76	13.01
130													13.82	15.08
140													14.88	17.30
150													15.95	19.66
160										17.01	22.16			
170										18.07	24.79			
180											12.39			
190											13.07			
200											13.76			
220											15.14			
240											16.51			
260											17.89			
280											19.27			
300											21.68			
320														
340											15.45			
360											16.42			
380											17.38			
400											18.35			
420														
440														
460														
480														
500														

See page 166 for friction loss formulas.

FRICTION LOSS CHARACTERISTICS

TYPE 'L' COPPER TUBING

Size: 1/2" thru 3" Flow: 1 thru 500GPM
 C=140 PSI LOSS PER 100 FEET OF PIPE (PSI/100 FT)

size	1/2"		5/8"		3/4"		1"		1"		1 1/2"		2"		2 1/2"		3"	
Avg.ID	0.545		0.666		0.785		1.025		1.265		1.505		1.985		2.465		2.945	
Pipe OD	0.625		0.750		0.875		1.125		1.375		1.625		2.125		2.625		3.125	
Avg Wall	0.040		0.042		0.045		0.050		0.055		0.060		0.070		0.080		0.090	
Flow GPM	Velocity FPS	PSI Loss	Velocity FPS	PSI Loss	Velocity FPS	PSI Loss	Velocity FPS	PSI Loss	Velocity FPS	PSI Loss	Velocity FPS	PSI Loss	Velocity FPS	PSI Loss	Velocity FPS	PSI Loss	Velocity FPS	PSI Loss
1	1.37	0.93	0.92	0.35	0.66	0.16	0.39	0.04	0.25	0.02								
2	2.75	3.35	1.84	1.26	1.32	0.57	0.78	0.15	0.51	0.06								
3	4.12	7.09	2.76	2.67	1.99	1.20	1.17	0.33	0.76	0.12								
4	5.49	12.09	3.68	4.56	2.65	2.05	1.55	0.56	1.02	0.20								
5	6.87	18.27	4.60	6.89	3.31	3.09	1.94	0.85	1.27	0.30								
6	8.24	25.61	5.52	9.65	3.97	4.34	2.33	1.18	1.53	0.43	1.08	0.18						
7	9.62	34.07	6.44	12.84	4.63	5.77	2.72	1.58	1.78	0.57	1.26	0.24						
8	10.99	43.63	7.36	16.45	5.30	7.39	3.11	2.02	2.04	0.72	1.44	0.31						
9	12.36	54.26	8.28	20.45	5.96	9.19	3.50	2.51	2.29	0.90	1.62	0.39						
10	13.74	65.95	9.20	24.86	6.62	11.17	3.88	3.05	2.55	1.10	1.80	0.47						
12			11.04	34.85	7.95	15.66	4.66	4.28	3.06	1.54	2.16	0.66	1.24	0.17				
14			12.88	46.36	9.27	20.83	5.44	5.69	3.57	2.04	2.52	0.88	1.45	0.23				
16			14.72	59.37	10.59	26.68	6.21	7.28	4.08	2.62	2.88	1.12	1.66	0.29				
18			16.56	73.84	11.92	33.18	6.99	9.06	4.59	3.25	3.24	1.40	1.86	0.36				
20					13.24	40.33	7.77	11.01	5.10	3.96	3.60	1.70	2.07	0.44				
22					14.57	48.11	8.54	13.14	5.61	4.72	3.96	2.03	2.28	0.53	1.48	0.18	1.03	0.08
24					15.89	56.53	9.32	15.44	6.12	5.55	4.32	2.38	2.49	0.62	1.61	0.22	1.13	0.09
26							10.10	17.90	6.63	6.43	4.68	2.76	2.69	0.72	1.75	0.25	1.22	0.11
28							10.87	20.54	7.14	7.38	5.04	3.17	2.90	0.82	1.88	0.29	1.32	0.12
30							11.65	23.33	7.65	8.38	5.40	3.60	3.11	0.94	2.01	0.33	1.41	0.14
32							12.43	26.30	8.16	9.45	5.76	4.06	3.31	1.05	2.15	0.37	1.51	0.15
34							13.20	29.42	8.67	10.57	6.12	4.54	3.52	1.18	2.28	0.41	1.60	0.17
36							13.98	32.71	9.18	11.75	6.48	5.05	3.73	1.31	2.42	0.46	1.69	0.19
38							14.76	36.15	9.69	12.99	6.84	5.58	3.93	1.45	2.55	0.51	1.79	0.21
40							15.53	39.75	10.20	14.28	7.21	6.13	4.14	1.59	2.69	0.56	1.88	0.23
42							16.31	43.51	10.71	15.63	7.57	6.71	4.35	1.75	2.82	0.61	1.98	0.26
44									11.22	17.04	7.93	7.32	4.56	1.90	2.95	0.66	2.07	0.28
46									11.73	18.50	8.29	7.94	4.76	2.07	3.09	0.72	2.16	0.30
48									12.24	20.02	8.65	8.60	4.97	2.24	3.22	0.78	2.26	0.33
50									12.75	21.59	9.01	9.27	5.18	2.41	3.36	0.84	2.35	0.35
55									14.02	25.76	9.91	11.06	5.70	2.88	3.69	1.00	2.59	0.42
60									15.30	30.26	10.81	13.00	6.21	3.38	4.03	1.18	2.82	0.50
65									16.57	35.10	11.71	15.07	6.73	3.92	4.36	1.37	3.06	0.57
70									17.85	40.26	12.61	17.29	7.25	4.50	4.70	1.57	3.29	0.66
75											13.51	19.65	7.77	5.11	5.04	1.78	3.53	0.75
80											14.41	22.14	8.28	5.76	5.37	2.01	3.76	0.84
85											15.31	24.77	8.80	6.44	5.71	2.25	4.00	0.94
90											16.21	27.54	9.32	7.16	6.04	2.50	4.23	1.05
95											17.11	30.44	9.84	7.91	6.38	2.76	4.47	1.16
100											18.01	33.47	10.35	8.70	6.71	3.03	4.70	1.28
110													11.39	10.38	7.39	3.62	5.17	1.52
120													12.43	12.20	8.06	4.25	5.65	1.79
130													13.46	14.15	8.73	4.93	6.12	2.07
140													14.50	16.23	9.40	5.66	6.59	2.38
150													15.53	18.44	10.07	6.43	7.06	2.70
160													16.57	20.78	10.74	7.24	7.53	3.05
170													17.60	23.25	11.41	8.11	8.00	3.41
180															12.09	9.01	8.47	3.79
190															12.76	9.96	8.94	4.19
200															13.43	10.95	9.41	4.61
220															14.77	13.07	10.35	5.50
240															16.12	15.35	11.29	6.46
260															17.46	17.80	12.23	7.49
280															18.80	20.42	13.17	8.59
300																	14.11	9.76
320																	15.05	11.00
340																	15.99	12.31
360																	16.94	13.69
380																	17.88	15.13
400																		
420																		
440																		
460																		
480																		
500																		

Shaded area represents velocities over 7 fps.
 Use with caution, where water hammer is a concern.

See page 166 for friction loss formulas.

FRICITION LOSS CHARACTERISTICS

TYPE 'M' COPPER TUBING

Size: 1/2" thru 3" Flow: 1 thru 500GPM
 C=140 PSI LOSS PER 100 FEET OF PIPE (PSI/100 FT)

size	1/2"		5/8"		3/4"		1"		1 1/4"		1 1/2"		2"		2 1/2"		3"	
Avg.ID	0.569		0.690		0.811		1.055		1.291		1.527		2.009		2.495		2.981	
Pipe OD	0.625		0.750		0.875		1.125		1.375		1.625		2.125		2.625		3.125	
Avg Wall	0.028		0.030		0.032		0.035		0.042		0.049		0.058		0.065		0.072	
Flow GPM	Velocity FPS	PSI Loss	Velocity FPS	PSI Loss	Velocity FPS	PSI Loss	Velocity FPS	PSI Loss	Velocity FPS	PSI Loss	Velocity FPS	PSI Loss	Velocity FPS	PSI Loss	Velocity FPS	PSI Loss	Velocity FPS	PSI Loss
1	1.26	0.75	0.86	0.29	0.62	0.13	0.37	0.04	0.24	0.01								
2	2.52	2.71	1.71	1.06	1.24	0.48	0.73	0.13	0.49	0.05								
3	3.78	5.75	2.57	2.25	1.86	1.03	1.10	0.29	0.73	0.11								
4	5.04	9.80	3.43	3.83	2.48	1.75	1.47	0.49	0.98	0.18								
5	6.30	14.81	4.28	5.80	3.10	2.64	1.83	0.73	1.22	0.27								
6	7.56	20.76	5.14	8.13	3.72	3.70	2.20	1.03	1.47	0.39	1.05	0.17						
7	8.82	27.62	6.00	10.81	4.34	4.92	2.57	1.37	1.71	0.51	1.22	0.23						
8	10.08	35.37	6.86	13.84	4.96	6.31	2.93	1.75	1.96	0.66	1.40	0.29						
9	11.34	44.00	7.71	17.22	5.58	7.84	3.30	2.18	2.20	0.82	1.57	0.36						
10	12.60	53.48	8.57	20.93	6.20	9.53	3.67	2.65	2.45	0.99	1.75	0.44						
12			10.28	29.33	7.44	13.36	4.40	3.72	2.94	1.39	2.10	0.61	1.21	0.16				
14			12.00	39.02	8.68	17.78	5.13	4.94	3.43	1.85	2.45	0.82	1.42	0.22				
16			13.71	49.97	9.93	22.77	5.87	6.33	3.92	2.37	2.80	1.05	1.62	0.28				
18			15.43	62.15	11.17	28.32	6.60	7.87	4.41	2.95	3.15	1.30	1.82	0.34				
20			17.14	75.55	12.41	34.42	7.33	9.57	4.90	3.58	3.50	1.58	2.02	0.42				
22					13.65	41.06	8.06	11.42	5.39	4.28	3.85	1.89	2.22	0.50	1.44	0.17	1.01	0.07
24					14.89	48.24	8.80	13.41	5.88	5.02	4.20	2.22	2.43	0.58	1.57	0.20	1.10	0.09
26							9.53	15.56	6.36	5.83	4.55	2.57	2.63	0.68	1.70	0.24	1.19	0.10
28							10.26	17.85	6.85	6.68	4.90	2.95	2.83	0.78	1.84	0.27	1.29	0.11
30							11.00	20.28	7.34	7.59	5.25	3.35	3.03	0.88	1.97	0.31	1.38	0.13
32							11.73	22.85	7.83	8.56	5.60	3.78	3.23	0.99	2.10	0.35	1.47	0.15
34							12.46	25.57	8.32	9.57	5.95	4.23	3.44	1.11	2.23	0.39	1.56	0.16
36							13.20	28.42	8.81	10.64	6.30	4.70	3.64	1.24	2.36	0.43	1.65	0.18
38							13.93	31.42	9.30	11.76	6.65	5.20	3.84	1.37	2.49	0.48	1.74	0.20
40							14.66	34.55	9.79	12.94	7.00	5.71	4.04	1.50	2.62	0.52	1.84	0.22
42							15.40	37.81	10.28	14.16	7.35	6.26	4.25	1.65	2.75	0.57	1.93	0.24
44									10.77	15.43	7.70	6.82	4.45	1.79	2.88	0.63	2.02	0.26
46									11.26	16.76	8.05	7.40	4.65	1.95	3.01	0.68	2.11	0.29
48									11.75	18.13	8.40	8.01	4.85	2.11	3.15	0.73	2.20	0.31
50									12.24	19.56	8.75	8.64	5.05	2.27	3.28	0.79	2.30	0.33
55									13.46	23.33	9.62	10.31	5.56	2.71	3.60	0.95	2.53	0.40
60									14.69	27.41	10.50	12.11	6.07	3.19	3.93	1.11	2.75	0.47
65									15.91	31.79	11.37	14.04	6.57	3.70	4.26	1.29	2.98	0.54
70									17.14	36.47	12.25	16.11	7.08	4.24	4.59	1.48	3.21	0.62
75											13.12	18.31	7.58	4.82	4.92	1.68	3.44	0.71
80											14.00	20.63	8.09	5.43	5.24	1.89	3.67	0.80
85											14.87	23.08	8.59	6.07	5.57	2.12	3.90	0.89
90											15.75	25.66	9.10	6.75	5.90	2.35	4.13	0.99
95											16.62	28.36	9.60	7.46	6.23	2.60	4.36	1.09
100											17.50	31.19	10.11	8.21	6.55	2.86	4.59	1.20
110													11.12	9.79	7.21	3.41	5.05	1.44
120													12.13	11.51	7.87	4.01	5.51	1.69
130													13.14	13.34	8.52	4.65	5.97	1.96
140													14.15	15.31	9.18	5.33	6.43	2.24
150													15.16	17.39	9.83	6.06	6.89	2.55
160													16.17	19.60	10.49	6.83	7.35	2.87
170													17.18	21.93	11.14	7.64	7.81	3.21
180															11.80	8.50	8.26	3.57
190															12.45	9.39	8.72	3.95
200															13.11	10.33	9.18	4.34
220															14.42	12.32	10.10	5.18
240															15.73	14.47	11.02	6.09
260															17.04	16.79	11.94	7.06
280															18.35	19.25	12.86	8.10
300																	13.77	9.20
320																	14.69	10.37
340																	15.61	11.60
360																	16.53	12.90
380																	17.45	14.26
400																		
420																		
440																		
460																		
480																		
500																		

Shaded area represents velocities over 7 fps.
 Use with caution, where water hammer is a concern.

See page 166 for friction loss formulas.

FRICITION LOSS CHARACTERISTICS

HDPE DR 7 265 PSI (IPS SIZE, OD CONTROLLED)

Size: 3" thru 18" Flow: 50 thru 4000GPM

ANSI/ASÆ S376.3 PE3408, ASTM D2239 C=150 PSI LOSS PER 100 FEET OF PIPE (PSI/100 FT)

size	3"		4"		6"		8"		10"		12"		14"		16"		18"	
Avg.ID	2.440		3.136		4.589		6.013		7.494		8.890		9.760		11.156		12.550	
Pipe OD	3.500		4.500		6.625		8.625		10.750		12.750		14.000		16.000		18.000	
Avg Wall	0.530		0.682		1.018		1.306		1.628		1.930		2.120		2.422		2.725	
Min Wall	0.500		0.643		0.946		1.232		1.536		1.821		2.000		2.286		2.571	
Flow GPM	Velocity FPS	PSI Loss	Velocity FPS	PSI Loss	Velocity FPS	PSI Loss	Velocity FPS	PSI Loss	Velocity FPS	PSI Loss	Velocity FPS	PSI Loss	Velocity FPS	PSI Loss	Velocity FPS	PSI Loss	Velocity FPS	PSI Loss
50	3.43	0.78	2.07	0.23	0.97	0.04	0.56	0.01	0.36	0.00	0.26	0.00	0.21	0.00	0.16	0.00	0.13	0.00
60	4.11	1.09	2.49	0.32	1.16	0.05	0.68	0.01	0.44	0.00	0.31	0.00	0.26	0.00	0.20	0.00	0.16	0.00
70	4.80	1.45	2.90	0.43	1.36	0.07	0.79	0.02	0.51	0.01	0.36	0.00	0.30	0.00	0.23	0.00	0.18	0.00
80	5.48	1.86	3.32	0.55	1.55	0.09	0.90	0.02	0.58	0.01	0.41	0.00	0.34	0.00	0.26	0.00	0.21	0.00
90	6.17	2.31	3.73	0.68	1.74	0.11	1.02	0.03	0.65	0.01	0.46	0.00	0.39	0.00	0.30	0.00	0.23	0.00
100	6.85	2.81	4.15	0.83	1.94	0.13	1.13	0.03	0.73	0.01	0.52	0.01	0.43	0.00	0.33	0.00	0.26	0.00
120	8.22	3.93	4.98	1.16	2.32	0.18	1.35	0.05	0.87	0.02	0.62	0.01	0.51	0.00	0.39	0.00	0.31	0.00
140	9.59	5.23	5.81	1.54	2.71	0.24	1.58	0.06	1.02	0.02	0.72	0.01	0.60	0.01	0.46	0.00	0.36	0.00
160	10.96	6.70	6.64	1.98	3.10	0.31	1.81	0.08	1.16	0.03	0.83	0.01	0.69	0.01	0.52	0.00	0.41	0.00
180			7.47	2.46	3.49	0.39	2.03	0.10	1.31	0.04	0.93	0.02	0.77	0.01	0.59	0.01	0.47	0.00
200			8.30	2.99	3.87	0.47	2.26	0.13	1.45	0.04	1.03	0.02	0.86	0.01	0.66	0.01	0.52	0.00
220			9.13	3.56	4.26	0.56	2.48	0.15	1.60	0.05	1.14	0.02	0.94	0.01	0.72	0.01	0.57	0.00
240			9.96	4.19	4.65	0.66	2.71	0.18	1.74	0.06	1.24	0.03	1.03	0.02	0.79	0.01	0.62	0.00
260			10.79	4.86	5.04	0.76	2.93	0.20	1.89	0.07	1.34	0.03	1.11	0.02	0.85	0.01	0.67	0.01
280			11.62	5.57	5.42	0.87	3.16	0.23	2.03	0.08	1.45	0.03	1.20	0.02	0.92	0.01	0.73	0.01
300					5.81	0.99	3.39	0.27	2.18	0.09	1.55	0.04	1.28	0.03	0.98	0.01	0.78	0.01
320					6.20	1.12	3.61	0.30	2.32	0.10	1.65	0.04	1.37	0.03	1.05	0.01	0.83	0.01
340					6.59	1.25	3.84	0.34	2.47	0.12	1.76	0.05	1.46	0.03	1.11	0.02	0.88	0.01
360					6.97	1.39	4.06	0.37	2.62	0.13	1.86	0.06	1.54	0.04	1.18	0.02	0.93	0.01
380					7.36	1.54	4.29	0.41	2.76	0.14	1.96	0.06	1.63	0.04	1.25	0.02	0.98	0.01
400					7.75	1.69	4.51	0.45	2.91	0.16	2.06	0.07	1.71	0.04	1.31	0.02	1.04	0.01
450					8.72	2.10	5.08	0.56	3.27	0.19	2.32	0.08	1.93	0.05	1.48	0.03	1.17	0.02
500					9.69	2.56	5.64	0.69	3.63	0.24	2.58	0.10	2.14	0.06	1.64	0.03	1.30	0.02
550					10.66	3.05	6.21	0.82	4.00	0.28	2.84	0.12	2.36	0.08	1.80	0.04	1.42	0.02
600					11.62	3.58	6.77	0.96	4.36	0.33	3.10	0.14	2.57	0.09	1.97	0.05	1.55	0.03
650							7.33	1.12	4.72	0.38	3.36	0.17	2.78	0.11	2.13	0.06	1.68	0.03
700							7.90	1.28	5.09	0.44	3.61	0.19	3.00	0.12	2.29	0.06	1.81	0.04
750							8.46	1.45	5.45	0.50	3.87	0.22	3.21	0.14	2.46	0.07	1.94	0.04
800							9.03	1.64	5.81	0.56	4.13	0.24	3.43	0.16	2.62	0.08	2.07	0.05
850							9.59	1.83	6.18	0.63	4.39	0.27	3.64	0.17	2.79	0.09	2.20	0.05
900							10.16	2.04	6.54	0.70	4.65	0.30	3.85	0.19	2.95	0.10	2.33	0.06
950							10.72	2.25	6.90	0.77	4.90	0.34	4.07	0.21	3.11	0.11	2.46	0.06
1000							11.28	2.48	7.26	0.85	5.16	0.37	4.28	0.23	3.28	0.12	2.59	0.07
1050							11.85	2.71	7.63	0.93	5.42	0.40	4.50	0.26	3.44	0.13	2.72	0.08
1100									7.99	1.01	5.68	0.44	4.71	0.28	3.61	0.15	2.85	0.08
1150									8.35	1.10	5.94	0.48	4.93	0.30	3.77	0.16	2.98	0.09
1200									8.72	1.19	6.19	0.52	5.14	0.33	3.93	0.17	3.11	0.10
1250									9.08	1.28	6.45	0.56	5.35	0.35	4.10	0.19	3.24	0.10
1300									9.44	1.38	6.71	0.60	5.57	0.38	4.26	0.20	3.37	0.11
1350									9.81	1.48	6.97	0.64	5.78	0.41	4.43	0.21	3.50	0.12
1400									10.17	1.58	7.23	0.69	6.00	0.44	4.59	0.23	3.63	0.13
1450									10.53	1.69	7.49	0.74	6.21	0.47	4.75	0.24	3.76	0.14
1500									10.90	1.80	7.74	0.78	6.42	0.50	4.92	0.26	3.89	0.15
1550									11.26	1.91	8.00	0.83	6.64	0.53	5.08	0.28	4.02	0.16
1600									11.62	2.03	8.26	0.88	6.85	0.56	5.25	0.29	4.14	0.16
1650											8.52	0.93	7.07	0.59	5.41	0.31	4.27	0.17
1700											8.78	0.99	7.28	0.63	5.57	0.33	4.40	0.18
1750											9.03	1.04	7.50	0.66	5.74	0.35	4.53	0.19
1800											9.29	1.10	7.71	0.70	5.90	0.36	4.66	0.21
1900											9.81	1.21	8.14	0.77	6.23	0.40	4.92	0.23
2000											10.32	1.33	8.57	0.85	6.56	0.44	5.18	0.25
2100											10.84	1.46	8.99	0.93	6.88	0.48	5.44	0.27
2200											11.36	1.59	9.42	1.01	7.21	0.53	5.70	0.30
2300											11.87	1.73	9.85	1.10	7.54	0.57	5.96	0.32
2400													10.28	1.19	7.87	0.62	6.22	0.35
2500													10.71	1.28	8.20	0.67	6.48	0.38
2600													11.14	1.38	8.52	0.72	6.74	0.41
2700													11.56	1.48	8.85	0.77	6.99	0.43
2800													11.99	1.58	9.18	0.82	7.25	0.46
2900															9.51	0.88	7.51	0.50
3000															9.83	0.94	7.77	0.53
3300															10.82	1.12	8.55	0.63
3600															11.80	1.31	9.33	0.74
3900																	10.10	0.86
4000																	10.36	0.90

See page 166 for friction loss formulas.

FRICTION LOSS CHARACTERISTICS

HDPE DR 9 200 PSI (IPS SIZE, OD CONTROLLED)

Size: 3" thru 18" Flow: 50 thru 4000GPM

ANSI/ASÆ S376.3 PE3408, ASTM D2239 C=150 PSI LOSS PER 100 FEET OF PIPE (PSI/100 FT)

size	3"		4"		6"		8"		10"		12"		14"		16"		18"	
Avg.ID	2.674		3.440		5.065		6.593		8.218		9.746		10.700		12.230		13.760	
Pipe OD	3.500		4.500		6.625		8.625		10.750		12.750		14.000		16.000		18.000	
Avg Wall	0.413		0.530		0.780		1.016		1.266		1.502		1.650		1.885		2.120	
Min Wall	0.389		0.500		0.736		0.958		1.194		1.417		1.556		1.778		2.000	
Flow GPM	Velocity FPS	PSI Loss	Velocity FPS	PSI Loss	Velocity FPS	PSI Loss	Velocity FPS	PSI Loss	Velocity FPS	PSI Loss	Velocity FPS	PSI Loss	Velocity FPS	PSI Loss	Velocity FPS	PSI Loss	Velocity FPS	PSI Loss
50	2.85	0.50	1.72	0.15	0.80	0.02												
60	3.42	0.70	2.07	0.20	0.95	0.03												
70	3.99	0.93	2.41	0.27	1.11	0.04												
80	4.56	1.19	2.76	0.35	1.27	0.05												
90	5.14	1.48	3.10	0.43	1.43	0.07												
100	5.71	1.80	3.45	0.53	1.59	0.08	0.94	0.02										
120	6.85	2.52	4.14	0.74	1.91	0.11	1.13	0.03										
140	7.99	3.35	4.83	0.98	2.23	0.15	1.31	0.04										
160	9.13	4.29	5.52	1.26	2.54	0.19	1.50	0.05	0.97	0.02								
180			6.21	1.57	2.86	0.24	1.69	0.07	1.09	0.02								
200			6.90	1.90	3.18	0.29	1.88	0.08	1.21	0.03								
220			7.59	2.27	3.50	0.35	2.06	0.10	1.33	0.03								
240			8.27	2.67	3.82	0.41	2.25	0.11	1.45	0.04	1.03	0.02						
260			8.96	3.10	4.13	0.47	2.44	0.13	1.57	0.04	1.12	0.02						
280			9.65	3.55	4.45	0.54	2.63	0.15	1.69	0.05	1.20	0.02						
300					4.77	0.61	2.82	0.17	1.81	0.06	1.29	0.03	1.07	0.02				
320					5.09	0.69	3.00	0.19	1.93	0.07	1.37	0.03	1.14	0.02				
340					5.41	0.77	3.19	0.21	2.05	0.07	1.46	0.03	1.21	0.02				
360					5.73	0.86	3.38	0.24	2.17	0.08	1.55	0.04	1.28	0.02				
380					6.04	0.95	3.57	0.26	2.30	0.09	1.63	0.04	1.35	0.02				
400					6.36	1.05	3.75	0.29	2.42	0.10	1.72	0.04	1.43	0.03				
450					7.16	1.30	4.22	0.36	2.72	0.12	1.93	0.05	1.60	0.03	1.23	0.02		
500					7.95	1.58	4.69	0.44	3.02	0.15	2.15	0.07	1.78	0.04	1.36	0.02		
550					8.75	1.89	5.16	0.52	3.32	0.18	2.36	0.08	1.96	0.05	1.50	0.03		
600					9.54	2.22	5.63	0.61	3.62	0.21	2.58	0.09	2.14	0.06	1.64	0.03	1.29	0.02
650							6.10	0.71	3.93	0.24	2.79	0.11	2.32	0.07	1.77	0.04	1.40	0.02
700							6.57	0.82	4.23	0.28	3.01	0.12	2.49	0.08	1.91	0.04	1.51	0.02
750							7.04	0.93	4.53	0.32	3.22	0.14	2.67	0.09	2.05	0.05	1.62	0.03
800							7.51	1.05	4.83	0.36	3.44	0.16	2.85	0.10	2.18	0.05	1.72	0.03
850							7.98	1.17	5.14	0.40	3.65	0.17	3.03	0.11	2.32	0.06	1.83	0.03
900							8.45	1.30	5.44	0.45	3.87	0.19	3.21	0.12	2.45	0.06	1.94	0.04
950							8.92	1.44	5.74	0.49	4.08	0.21	3.39	0.14	2.59	0.07	2.05	0.04
1000							9.39	1.58	6.04	0.54	4.30	0.24	3.56	0.15	2.73	0.08	2.15	0.04
1050							9.86	1.73	6.34	0.59	4.51	0.26	3.74	0.16	2.86	0.09	2.26	0.05
1100									6.65	0.65	4.72	0.28	3.92	0.18	3.00	0.09	2.37	0.05
1150									6.95	0.70	4.94	0.31	4.10	0.19	3.14	0.10	2.48	0.06
1200									7.25	0.76	5.15	0.33	4.28	0.21	3.27	0.11	2.59	0.06
1250									7.55	0.82	5.37	0.36	4.45	0.23	3.41	0.12	2.69	0.07
1300									7.85	0.88	5.58	0.38	4.63	0.24	3.55	0.13	2.80	0.07
1350									8.16	0.94	5.80	0.41	4.81	0.26	3.68	0.14	2.91	0.08
1400									8.46	1.01	6.01	0.44	4.99	0.28	3.82	0.15	3.02	0.08
1450									8.76	1.08	6.23	0.47	5.17	0.30	3.96	0.16	3.12	0.09
1500									9.06	1.15	6.44	0.50	5.35	0.32	4.09	0.17	3.23	0.09
1550									9.36	1.22	6.66	0.53	5.52	0.34	4.23	0.18	3.34	0.10
1600									9.67	1.29	6.87	0.56	5.70	0.36	4.36	0.19	3.45	0.11
1650									9.97	1.37	7.09	0.60	5.88	0.38	4.50	0.20	3.56	0.11
1700											7.30	0.63	6.06	0.40	4.64	0.21	3.66	0.12
1750											7.52	0.67	6.24	0.42	4.77	0.22	3.77	0.12
1800											7.73	0.70	6.41	0.45	4.91	0.23	3.88	0.13
1900											8.16	0.78	6.77	0.49	5.18	0.26	4.09	0.14
2000											8.59	0.85	7.13	0.54	5.46	0.28	4.31	0.16
2100											9.02	0.93	7.48	0.59	5.73	0.31	4.53	0.17
2200											9.45	1.02	7.84	0.65	6.00	0.34	4.74	0.19
2300											9.88	1.10	8.20	0.70	6.27	0.37	4.96	0.21
2400													8.55	0.76	6.55	0.40	5.17	0.22
2500													8.91	0.82	6.82	0.43	5.39	0.24
2600													9.27	0.88	7.09	0.46	5.60	0.26
2700													9.62	0.94	7.36	0.49	5.82	0.28
2800													9.98	1.01	7.64	0.53	6.03	0.30
2900															7.91	0.56	6.25	0.32
3000															8.18	0.60	6.46	0.34
3300															9.00	0.71	7.11	0.40
3600															9.82	0.84	7.76	0.47
3900																	8.40	0.55
4000																	8.62	0.57

Shaded area represents velocities over 5 fps. Use with caution.

See page 166 for friction loss formulas.

FRICITION LOSS CHARACTERISTICS

HDPE DR 11 160 PSI (IPS SIZE, OD CONTROLLED)

Size: 3" thru 18" Flow: 50 thru 4000GPM

ANSI/ASÆ S376.2 PE3408, ASTM D2239 C=150

PSI LOSS PER 100 FEET OF PIPE (PSI/100 FT)

size	3"		4"		6"		8"		10"		12"		14"		16"		18"	
Avg.ID	2.826		3.632		5.349		6.963		8.678		10.292		11.300		12.914		14.532	
Pipe OD	3.500		4.500		6.625		8.625		10.750		12.750		14.000		16.000		18.000	
Avg Wall	0.337		0.434		0.638		0.831		1.036		1.229		1.350		1.543		1.734	
Min Wall	0.318		0.409		0.602		0.784		0.977		1.159		1.273		1.455		1.636	
Flow GPM	Velocity FPS	PSI Loss	Velocity FPS	PSI Loss	Velocity FPS	PSI Loss	Velocity FPS	PSI Loss	Velocity FPS	PSI Loss	Velocity FPS	PSI Loss	Velocity FPS	PSI Loss	Velocity FPS	PSI Loss	Velocity FPS	PSI Loss
50	2.55	0.38	1.55	0.11	0.71	0.02												
60	3.07	0.53	1.86	0.16	0.86	0.02												
70	3.58	0.71	2.17	0.21	1.00	0.03												
80	4.09	0.91	2.47	0.27	1.14	0.04												
90	4.60	1.13	2.78	0.33	1.28	0.05												
100	5.11	1.37	3.09	0.40	1.43	0.06	0.84	0.02										
120	6.13	1.92	3.71	0.57	1.71	0.09	1.01	0.02										
140	7.15	2.56	4.33	0.76	2.00	0.11	1.18	0.03										
160	8.17	3.28	4.95	0.97	2.28	0.15	1.35	0.04										
180	9.20	4.08	5.57	1.20	2.57	0.18	1.51	0.05										
200	10.22	4.96	6.19	1.46	2.85	0.22	1.68	0.06	1.08	0.02	0.77	0.01						
220	11.24	5.91	6.80	1.74	3.14	0.27	1.85	0.07	1.19	0.03	0.85	0.01						
240	12.26	6.95	7.42	2.05	3.42	0.31	2.02	0.09	1.30	0.03	0.92	0.01						
260			8.04	2.38	3.71	0.36	2.19	0.10	1.41	0.03	1.00	0.01						
280			8.66	2.73	3.99	0.41	2.36	0.11	1.52	0.04	1.08	0.02						
300			9.28	3.10	4.28	0.47	2.52	0.13	1.63	0.04	1.16	0.02						
320			9.90	3.49	4.56	0.53	2.69	0.15	1.73	0.05	1.23	0.02						
340			10.52	3.91	4.85	0.59	2.86	0.16	1.84	0.06	1.31	0.02	1.09	0.02				
360			11.13	4.34	5.13	0.66	3.03	0.18	1.95	0.06	1.39	0.03	1.15	0.02				
380					5.42	0.73	3.20	0.20	2.06	0.07	1.46	0.03	1.21	0.02				
400					5.70	0.80	3.37	0.22	2.17	0.08	1.54	0.03	1.28	0.02				
450					6.42	1.00	3.79	0.28	2.44	0.09	1.73	0.04	1.44	0.03				
500					7.13	1.21	4.21	0.34	2.71	0.12	1.93	0.05	1.60	0.03	1.22	0.02		
550					7.84	1.45	4.63	0.40	2.98	0.14	2.12	0.06	1.76	0.04	1.35	0.02		
600					8.56	1.70	5.05	0.47	3.25	0.16	2.31	0.07	1.92	0.04	1.47	0.02		
650					9.27	1.97	5.47	0.55	3.52	0.19	2.50	0.08	2.08	0.05	1.59	0.03		
700					9.98	2.26	5.89	0.63	3.79	0.21	2.70	0.09	2.24	0.06	1.71	0.03	1.35	0.02
750					10.69	2.57	6.31	0.71	4.06	0.24	2.89	0.11	2.40	0.07	1.83	0.04	1.45	0.02
800							6.73	0.80	4.33	0.27	3.08	0.12	2.56	0.08	1.96	0.04	1.55	0.02
850							7.15	0.90	4.61	0.31	3.27	0.13	2.72	0.09	2.08	0.04	1.64	0.03
900							7.57	1.00	4.88	0.34	3.47	0.15	2.88	0.09	2.20	0.05	1.74	0.03
950							7.99	1.10	5.15	0.38	3.66	0.16	3.04	0.10	2.32	0.05	1.84	0.03
1000							8.42	1.21	5.42	0.42	3.85	0.18	3.20	0.12	2.45	0.06	1.93	0.03
1050							8.84	1.33	5.69	0.45	4.04	0.20	3.36	0.13	2.57	0.07	2.03	0.04
1100							9.26	1.45	5.96	0.50	4.24	0.22	3.51	0.14	2.69	0.07	2.13	0.04
1150							9.68	1.57	6.23	0.54	4.43	0.23	3.67	0.15	2.81	0.08	2.22	0.04
1200							10.10	1.70	6.50	0.58	4.62	0.25	3.83	0.16	2.94	0.08	2.32	0.05
1250							10.52	1.83	6.77	0.63	4.81	0.27	3.99	0.17	3.06	0.09	2.42	0.05
1300									7.04	0.68	5.01	0.29	4.15	0.19	3.18	0.10	2.51	0.05
1350									7.31	0.72	5.20	0.32	4.31	0.20	3.30	0.10	2.61	0.06
1400									7.58	0.78	5.39	0.34	4.47	0.21	3.43	0.11	2.70	0.06
1450									7.86	0.83	5.59	0.36	4.63	0.23	3.55	0.12	2.80	0.07
1500									8.13	0.88	5.78	0.38	4.79	0.24	3.67	0.13	2.90	0.07
1550									8.40	0.94	5.97	0.41	4.95	0.26	3.79	0.14	2.99	0.08
1600									8.67	0.99	6.16	0.43	5.11	0.27	3.91	0.14	3.09	0.08
1650									8.94	1.05	6.36	0.46	5.27	0.29	4.04	0.15	3.19	0.09
1700									9.21	1.11	6.55	0.48	5.43	0.31	4.16	0.16	3.28	0.09
1750									9.48	1.17	6.74	0.51	5.59	0.32	4.28	0.17	3.38	0.10
1800									9.75	1.23	6.93	0.54	5.75	0.34	4.40	0.18	3.48	0.10
1900									10.29	1.36	7.32	0.59	6.07	0.38	4.65	0.20	3.67	0.11
2000											7.70	0.65	6.39	0.42	4.89	0.22	3.86	0.12
2100											8.09	0.72	6.71	0.45	5.14	0.24	4.06	0.13
2200											8.47	0.78	7.03	0.50	5.38	0.26	4.25	0.15
2300											8.86	0.85	7.35	0.54	5.63	0.28	4.44	0.16
2400													7.67	0.58	5.87	0.30	4.64	0.17
2500													7.99	0.63	6.12	0.33	4.83	0.18
2600													8.31	0.68	6.36	0.35	5.02	0.20
2700													8.63	0.72	6.61	0.38	5.22	0.21
2800													8.95	0.77	6.85	0.40	5.41	0.23
2900															7.09	0.43	5.60	0.24
3000															7.34	0.46	5.80	0.26
3300															8.07	0.55	6.38	0.31
3600															8.81	0.64	6.96	0.36
3900																	7.53	0.42
4000																	7.73	0.44

See page 166 for friction loss formulas.

FRICITION LOSS CHARACTERISTICS

HDPE DR 13.5 128 PSI (IPS SIZE, OD CONTROLLED)

Size: 3" thru 18" Flow: 1 thru 4000GPM

ANSI/ASÆ S376.2 PE3408, ASTM D2239 C=150 PSI LOSS PER 100 FEET OF PIPE (PSI/100 FT)

size	3"		4"		6"		8"		10"		12"		14"		16"		18"	
Avg.ID	2.950		3.794		5.583		7.269		9.062		10.748		11.802		13.488		15.174	
Pipe OD	3.500		4.500		6.625		8.625		10.750		12.750		14.000		16.000		18.000	
Avg Wall	0.275		0.353		0.521		0.678		0.844		1.001		1.099		1.256		1.413	
Min Wall	0.259		0.333		0.491		0.639		0.796		0.944		1.037		1.185		1.333	
Flow GPM	Velocity FPS	PSI Loss	Velocity FPS	PSI Loss	Velocity FPS	PSI Loss	Velocity FPS	PSI Loss	Velocity FPS	PSI Loss	Velocity FPS	PSI Loss	Velocity FPS	PSI Loss	Velocity FPS	PSI Loss	Velocity FPS	PSI Loss
50	2.34	0.31	1.42	0.09	0.65	0.01												
60	2.81	0.43	1.70	0.13	0.79	0.02												
70	3.28	0.58	1.98	0.17	0.92	0.03												
80	3.75	0.74	2.27	0.22	1.05	0.03												
90	4.22	0.92	2.55	0.27	1.18	0.04												
100	4.69	1.11	2.83	0.33	1.31	0.05	0.77	0.01										
120	5.63	1.56	3.40	0.46	1.57	0.07	0.93	0.02										
140	6.56	2.08	3.97	0.61	1.83	0.09	1.08	0.03										
160	7.50	2.66	4.54	0.78	2.09	0.12	1.24	0.03										
180	8.44	3.31	5.10	0.97	2.36	0.15	1.39	0.04										
200			5.67	1.18	2.62	0.18	1.54	0.05	0.99	0.02	0.71	0.01						
220			6.24	1.41	2.88	0.22	1.70	0.06	1.09	0.02	0.78	0.01						
240			6.80	1.66	3.14	0.25	1.85	0.07	1.19	0.02	0.85	0.01						
260			7.37	1.92	3.40	0.29	2.01	0.08	1.29	0.03	0.92	0.01						
280			7.94	2.20	3.67	0.34	2.16	0.09	1.39	0.03	0.99	0.01						
300					3.93	0.38	2.32	0.11	1.49	0.04	1.06	0.02						
320					4.19	0.43	2.47	0.12	1.59	0.04	1.13	0.02						
340					4.45	0.48	2.63	0.13	1.69	0.05	1.20	0.02	1.00	0.01				
360					4.71	0.54	2.78	0.15	1.79	0.05	1.27	0.02	1.05	0.01				
380					4.97	0.59	2.93	0.16	1.89	0.06	1.34	0.02	1.11	0.02				
400					5.24	0.65	3.09	0.18	1.99	0.06	1.41	0.03	1.17	0.02				
450					5.89	0.81	3.47	0.22	2.24	0.08	1.59	0.03	1.32	0.02				
500					6.54	0.98	3.86	0.27	2.48	0.09	1.77	0.04	1.46	0.03	1.12	0.01		
550					7.20	1.17	4.25	0.33	2.73	0.11	1.94	0.05	1.61	0.03	1.23	0.02		
600					7.85	1.38	4.63	0.38	2.98	0.13	2.12	0.06	1.76	0.04	1.35	0.02		
650					8.51	1.60	5.02	0.44	3.23	0.15	2.30	0.07	1.90	0.04	1.46	0.02		
700							5.41	0.51	3.48	0.17	2.47	0.08	2.05	0.05	1.57	0.03	1.24	0.01
750							5.79	0.58	3.73	0.20	2.65	0.09	2.20	0.05	1.68	0.03	1.33	0.02
800							6.18	0.65	3.97	0.22	2.83	0.10	2.34	0.06	1.79	0.03	1.42	0.02
850							6.56	0.73	4.22	0.25	3.00	0.11	2.49	0.07	1.91	0.04	1.51	0.02
900							6.95	0.81	4.47	0.28	3.18	0.12	2.64	0.08	2.02	0.04	1.59	0.02
950							7.34	0.90	4.72	0.31	3.36	0.13	2.78	0.08	2.13	0.04	1.68	0.02
1000							7.72	0.98	4.97	0.34	3.53	0.15	2.93	0.09	2.24	0.05	1.77	0.03
1050							8.11	1.08	5.22	0.37	3.71	0.16	3.08	0.10	2.35	0.05	1.86	0.03
1100									5.47	0.40	3.89	0.18	3.22	0.11	2.47	0.06	1.95	0.03
1150									5.71	0.44	4.06	0.19	3.37	0.12	2.58	0.06	2.04	0.04
1200									5.96	0.47	4.24	0.21	3.52	0.13	2.69	0.07	2.13	0.04
1250									6.21	0.51	4.41	0.22	3.66	0.14	2.80	0.07	2.21	0.04
1300									6.46	0.55	4.59	0.24	3.81	0.15	2.92	0.08	2.30	0.04
1350									6.71	0.59	4.77	0.26	3.95	0.16	3.03	0.08	2.39	0.05
1400									6.96	0.63	4.94	0.27	4.10	0.17	3.14	0.09	2.48	0.05
1450									7.20	0.67	5.12	0.29	4.25	0.19	3.25	0.10	2.57	0.05
1500									7.45	0.71	5.30	0.31	4.39	0.20	3.36	0.10	2.66	0.06
1550									7.70	0.76	5.47	0.33	4.54	0.21	3.48	0.11	2.75	0.06
1600									7.95	0.80	5.65	0.35	4.69	0.22	3.59	0.12	2.84	0.07
1650									8.20	0.85	5.83	0.37	4.83	0.24	3.70	0.12	2.92	0.07
1700											6.00	0.39	4.98	0.25	3.81	0.13	3.01	0.07
1750											6.18	0.41	5.13	0.26	3.92	0.14	3.10	0.08
1800											6.36	0.44	5.27	0.28	4.04	0.14	3.19	0.08
1900											6.71	0.48	5.57	0.31	4.26	0.16	3.37	0.09
2000											7.06	0.53	5.86	0.34	4.49	0.18	3.54	0.10
2100											7.42	0.58	6.15	0.37	4.71	0.19	3.72	0.11
2200											7.77	0.63	6.44	0.40	4.93	0.21	3.90	0.12
2300											8.12	0.69	6.74	0.44	5.16	0.23	4.08	0.13
2400													7.03	0.47	5.38	0.25	4.25	0.14
2500													7.32	0.51	5.61	0.27	4.43	0.15
2600													7.62	0.55	5.83	0.29	4.61	0.16
2700													7.91	0.59	6.06	0.31	4.78	0.17
2800													8.20	0.63	6.28	0.33	4.96	0.18
2900															6.50	0.35	5.14	0.20
3000															6.73	0.37	5.32	0.21
3300															7.40	0.44	5.85	0.25
3600															8.07	0.52	6.38	0.29
3900																	6.91	0.34
4000																	7.09	0.36

Shaded area represents velocities over 5 fps.
Use with caution.

See page 166 for friction loss formulas.

FRICITION LOSS CHARACTERISTICS

C900 DR 18 CLASS 150 (C.I.O.D.)

Size: 4" thru 12" Flow: 25 thru 8500GPM
 AWWA C900 ASTM D1784 C=150 PSI LOSS PER 100 FEET OF PIPE (PSI/100 FT)

size	4"		6"		8"		10"		12"				
Avg.ID	4.234		6.088		7.984		9.792		11.646				
Pipe OD	4.800		6.900		9.050		11.100		13.200				
Avg Wall	0.283		0.406		0.533		0.654		0.777				
Min Wall	0.267		0.383		0.503		0.617		0.733				
Flow GPM	Velocity FPS	PSI Loss	Velocity FPS	PSI Loss	Velocity FPS	PSI Loss	Velocity FPS	PSI Loss	Velocity FPS	PSI Loss			
25	0.57	0.01	0.28	0.00	0.16	0.00	0.11	0.00	0.08	0.00			
50	1.14	0.05	0.55	0.01	0.32	0.00	0.21	0.00	0.15	0.00			
75	1.71	0.11	0.83	0.02	0.48	0.01	0.32	0.00	0.23	0.00			
100	2.28	0.19	1.10	0.03	0.64	0.01	0.43	0.00	0.30	0.00			
125	2.84	0.29	1.38	0.05	0.80	0.01	0.53	0.00	0.38	0.00			
150	3.41	0.41	1.65	0.07	0.96	0.02	0.64	0.01	0.45	0.00			
175	3.98	0.54	1.93	0.09	1.12	0.02	0.74	0.01	0.53	0.00			
200	4.55	0.69	2.20	0.12	1.28	0.03	0.85	0.01	0.60	0.01			
225	5.12	0.86	2.48	0.15	1.44	0.04	0.96	0.01	0.68	0.01			
250	5.69	1.05	2.75	0.18	1.60	0.05	1.06	0.02	0.75	0.01			
275	6.26	1.25	3.03	0.21	1.76	0.06	1.17	0.02	0.83	0.01			
300	6.83	1.47	3.30	0.25	1.92	0.07	1.28	0.02	0.90	0.01			
325	7.40	1.70	3.58	0.29	2.08	0.08	1.38	0.03	0.98	0.01			
350	7.97	1.95	3.85	0.33	2.24	0.09	1.49	0.03	1.05	0.01			
375	8.53	2.22	4.13	0.38	2.40	0.10	1.60	0.04	1.13	0.02			
400	9.10	2.50	4.40	0.43	2.56	0.11	1.70	0.04	1.20	0.02			
450			4.95	0.53	2.88	0.14	1.91	0.05	1.35	0.02			
500			5.50	0.65	3.20	0.17	2.13	0.06	1.50	0.03			
550			6.05	0.77	3.52	0.21	2.34	0.08	1.65	0.03			
600			6.60	0.91	3.84	0.24	2.55	0.09	1.80	0.04			
700			7.71	1.20	4.48	0.32	2.98	0.12	2.11	0.05			
800			8.81	1.54	5.12	0.41	3.40	0.15	2.41	0.07			
900			9.91	1.92	5.76	0.51	3.83	0.19	2.71	0.08			
1000					6.40	0.62	4.26	0.23	3.01	0.10			
1100					7.04	0.74	4.68	0.28	3.31	0.12			
1200					7.68	0.87	5.11	0.32	3.61	0.14			
1300					8.32	1.01	5.53	0.38	3.91	0.16			
1400					8.96	1.16	5.96	0.43	4.21	0.19			
1500					9.60	1.32	6.38	0.49	4.51	0.21			
1600					10.24	1.49	6.81	0.55	4.81	0.24			
1700							7.23	0.62	5.11	0.27			
1800							7.66	0.69	5.41	0.29			
1900							8.08	0.76	5.72	0.33			
2000							8.51	0.83	6.02	0.36			
2100							8.94	0.91	6.32	0.39			
2200							9.36	0.99	6.62	0.43			
2300									6.92	0.46			
2400									7.22	0.50			
2500									7.52	0.54			
2600									7.82	0.58			
2700									8.12	0.63			
2800													
2900													
3000													
3100													
3200													
3300													
3400													
3500													
3600													
3800			Shaded area represents velocities over 5 fps. Use with caution.										
3900													
4000													
4200													
4400													
4600													
4800													
5000													
5500													
6000													
6500													
7000													
7500													
8000													
8500													

See page 166 for friction loss formulas.

FRICITION LOSS CHARACTERISTICS

C900 DR 25 CLASS 100 (C.I.O.D.)

Size: 4" thru 12" Flow: 25 thru 8500GPM
 AWWA C900 ASTM D1784 C=150 PSI LOSS PER 100 FEET OF PIPE (PSI/100 FT)

size	4"		6"		8"		10"		12"	
Avg.ID	4.392		6.314		8.282		10.158		12.080	
Pipe OD	4.800		6.900		9.050		11.100		13.200	
Avg Wall	0.204		0.293		0.384		0.471		0.560	
Min Wall	0.192		0.276		0.362		0.444		0.528	
Flow GPM	Velocity FPS	PSI Loss	Velocity FPS	PSI Loss	Velocity FPS	PSI Loss	Velocity FPS	PSI Loss	Velocity FPS	PSI Loss
25	0.53	0.01	0.26	0.00	0.15	0.00	0.10	0.00	0.07	0.00
50	1.06	0.04	0.51	0.01	0.30	0.00	0.20	0.00	0.14	0.00
75	1.59	0.09	0.77	0.02	0.45	0.00	0.30	0.00	0.21	0.00
100	2.12	0.16	1.02	0.03	0.59	0.01	0.40	0.00	0.28	0.00
125	2.64	0.24	1.28	0.04	0.74	0.01	0.49	0.00	0.35	0.00
150	3.17	0.34	1.54	0.06	0.89	0.02	0.59	0.01	0.42	0.00
175	3.70	0.45	1.79	0.08	1.04	0.02	0.69	0.01	0.49	0.00
200	4.23	0.58	2.05	0.10	1.19	0.03	0.79	0.01	0.56	0.00
225	4.76	0.72	2.30	0.12	1.34	0.03	0.89	0.01	0.63	0.01
250	5.29	0.88	2.56	0.15	1.49	0.04	0.99	0.01	0.70	0.01
275	5.82	1.05	2.81	0.18	1.64	0.05	1.09	0.02	0.77	0.01
300	6.35	1.23	3.07	0.21	1.78	0.06	1.19	0.02	0.84	0.01
325	6.87	1.43	3.33	0.24	1.93	0.07	1.29	0.02	0.91	0.01
350	7.40	1.63	3.58	0.28	2.08	0.07	1.38	0.03	0.98	0.01
375			3.84	0.32	2.23	0.08	1.48	0.03	1.05	0.01
400			4.09	0.36	2.38	0.10	1.58	0.04	1.12	0.02
450			4.61	0.45	2.68	0.12	1.78	0.04	1.26	0.02
500			5.12	0.54	2.97	0.14	1.98	0.05	1.40	0.02
550			5.63	0.65	3.27	0.17	2.17	0.06	1.54	0.03
600			6.14	0.76	3.57	0.20	2.37	0.08	1.68	0.03
700			7.16	1.01	4.16	0.27	2.77	0.10	1.96	0.04
800			8.19	1.29	4.76	0.35	3.16	0.13	2.24	0.05
900			9.21	1.61	5.35	0.43	3.56	0.16	2.52	0.07
1000			10.23	1.95	5.95	0.52	3.95	0.19	2.80	0.08
1100					6.54	0.62	4.35	0.23	3.08	0.10
1200					7.14	0.73	4.74	0.27	3.36	0.12
1300					7.73	0.85	5.14	0.31	3.63	0.14
1400					8.33	0.97	5.54	0.36	3.91	0.16
1500					8.92	1.11	5.93	0.41	4.19	0.18
1600					9.52	1.25	6.33	0.46	4.47	0.20
1700							6.72	0.52	4.75	0.22
1800							7.12	0.57	5.03	0.25
1900							7.51	0.63	5.31	0.27
2000							7.91	0.70	5.59	0.30
2100							8.30	0.76	5.87	0.33
2200							8.70	0.83	6.15	0.36
2300									6.43	0.39
2400									6.71	0.42
2500									6.99	0.45
2600									7.27	0.49
2700									7.55	0.52
2800									7.83	0.56
2900									8.11	0.60
3000									8.39	0.64
3100									8.67	0.68
3200										
3300										
3400										
3500										
3600										
3800										
3900										
4000										
4200										
4400										
4600										
4800										
5000										
5500										
6000										
6500										
7000										
7500										
8000										
8500										

Shaded area represents velocities over 5 fps.
Use with caution.

See page 166 for friction loss formulas.

PRESSURE LOSS THROUGH WATER METERS

WATER METER PRESSURE LOSS (PSI)

FLOW GPM	NOMINAL SIZE						
	5/8"	3/4"	1"	1 1/2"	2"	3"	4"
1	0.2	0.1					
2	0.3	0.2					
3	0.4	0.3					
4	0.6	0.5	0.1				
5	0.9	0.6	0.2				
6	1.3	0.7	0.3				
7	1.8	0.8	0.4				
8	2.3	1.0	0.5				
9	3.0	1.3	0.6				
10	3.7	1.6	0.7				
11	4.4	1.9	0.8				
12	5.1	2.2	0.9				
13	6.1	2.6	1.0				
14	7.2	3.1	1.1				
15	8.3	3.6	1.2				
16	9.4	4.1	1.4	0.4			
17	10.7	4.6	1.6	0.5			
18	12.0	5.2	1.8	0.6			
19	13.4	5.8	2.0	0.7			
20	15.0	6.5	2.2	0.8			
22		7.9	2.8	1.0			
24		9.5	3.4	1.2			
26		11.2	4.0	1.4			
28		13.0	4.6	1.6			
30		15.0	5.3	1.8	0.7		
32			6.0	2.1	0.8		
34			6.9	2.4	0.9		
36			7.8	2.7	1.0		
38			8.7	3.0	1.2		
40			9.6	3.3	1.3		
42			10.6	3.6	1.4		
44			11.7	3.9	1.5		
46			12.8	4.2	1.6		
48			13.9	4.5	1.7		
50			15.0	4.9	1.9	0.7	
52				5.3	2.1		
54				5.7	2.2		
56				6.2	2.3		
58				6.7	2.5		
60				7.2	2.7	1.0	
65				8.3	3.2	1.1	
70				9.8	3.7	1.3	
75				11.3	4.3	1.5	
80				12.8	4.9	1.6	0.7
90				16.1	6.2	2.0	0.8
100				20.0	7.8	2.5	0.9
110					9.5	2.9	1.0
120					11.3	3.4	1.2
130					13.0	3.9	1.4
140					15.1	4.5	1.6
150					17.3	5.1	1.8
160					20.0	5.8	2.1
170						6.5	2.4
180						7.2	2.7
190						8.0	3.0
200						9.0	3.2
220						11.0	3.9
240						13.0	4.7
260						15.0	5.5
280						17.3	6.3
300						20.0	7.2
350							10.0
400							13.0
450							16.2
500							20.0

SLOPE, ANGLE & RATIO PRECIPITATION RATES

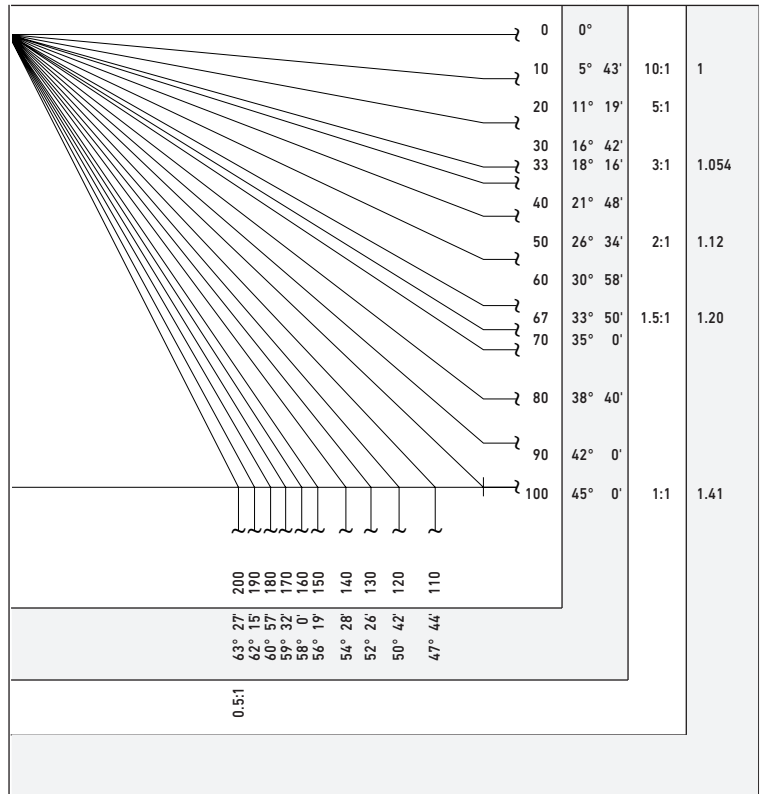

MAXIMUM PRECIPITATION RATES

Soil Texture	Maximum Precipitation Rates: Inches Per Hour							
	0 to 5% slope		5 to 8% slope		8 to 12% slope		12% + slope	
	Cover	Bare	Cover	Bare	Cover	Bare	Cover	Bare
Coarse sandy soils	2.00	2.00	2.00	1.50	1.50	1.0	1.0	0.50
Coarse sandy soils over compact subsoils	1.75	1.50	1.25	1.00	1.00	0.75	0.75	0.40
Uniform light sandy loams	1.75	1.00	1.25	0.80	1.00	0.60	0.75	0.40
Light sandy loams over compact subsoils	1.25	0.75	1.00	0.50	0.75	0.40	0.50	0.30
Uniform silt loams	1.00	0.50	0.80	0.40	0.60	0.30	0.40	0.20
Silt loams over compact subsoil	0.60	0.30	0.50	0.25	0.40	0.15	0.30	0.10
Heavy clay or clay loam	0.20	0.15	0.15	0.10	0.12	0.08	0.10	0.06

The maximum PR values listed are as suggested by the United States Department of Agriculture. The values are average and may vary with respect to actual soil condition and condition of ground cover.

WIRE SIZING

METHOD OF WIRE SIZING FOR ELECTRICAL COMPONENTS OF AN AUTOMATIC IRRIGATION SYSTEM

Data Needed

- Maximum current draw of the electrical unit (valve or controller) in amperes (I)
- Distance in feet (one way) to the electrical unit (F)
- The allowable voltage drop in the wire without affecting functions of the electrical unit (Vd)

Steps

1. Calculate the maximum allowable wire resistance per 1000 feet with the following formula:

$$R = \frac{500 \times Vd}{F \times I}$$

where R = allowable wire resistance per 1000 feet.

2. Select the wire size from Chart #2 which has a resistance less than that calculated in the above formula.

Example: A valve with a minimum operating voltage of 20 volts and inrush current of .30 amps is to be located 2680 ft. from a controller. The controller minimum output voltage is 24 V ac.

The allowable voltage drop (Vd) = 24 – 20 = 4 volts
 The distance to valve (F) = 2680 ft.
 The current draw (I) = .3 amps

$$R = \frac{500 \times 4}{2680 \times .3} = 2.49 \text{ ohm}/1000 \text{ ft.}$$

From Chart #2 we find that #14 AWG wire has slightly too much resistance. Therefore, choose #12 AWG copper wire.

The accompanying charts are useful for quick and easy selection of wire sizes for valves with standard and optional solenoids. Chart #3 is set up to provide maximum wire runs given a standard 24 V ac valve with a minimum operating voltage of 20 volts and a controller output of 24 V ac Chart #4 is a multiplier factor for determining maximum wire runs for other controller output voltages and optional solenoids.

Example: Determine maximum wire run to a valve with model 24 Vac-D solenoid and controller output voltage of 26 volts and #14 control and ground wire.

From Chart #3 we find a length of 2590 ft. with #14 ground and control wire. From Chart #4 the multiplier factor at 26 Vac controller output with a model 24 Vac-D solenoid is 4.33. Therefore, the maximum wire distance to the valve is: 4.33 x 2590 feet = 11,215 feet.

* This assumes control wire and ground wire are the same size.

MINIMUM OPERATING VOLTAGES AT VARIOUS STATIC PRESSURES (STANDARD 24 VAC SOLENOID)

CHART 1

Minimum Solenoid Operating Voltage Under Various Line Pressure

Line Pressure	Voltage (Internal Bleed Configurations)	Voltage (External Bleed Configurations)
200 psi	21.1	
175 psi	20.2	
150 psi	19.1	20.0
125 psi	18.2	19.1
100 psi	17.1	18.2
75 psi	16.1	17.3
50 psi	16.0	16.4

CHART 2

Copper Wire Resistance of Various Sizes

Sizes AWG	Resistance at 20°C Ohms per 1000 ft.
4	0.25
6	0.40
8	0.64
10	1.02
12	1.62
14	2.57
16	4.10
18	6.51

CHART 3

Maximum One-way Distance (ft.) Between Controller and Valve (standard 24 Vac solenoid) †

Ground Wire	Valve Wire Sizing						
	18	16	14	12	10	8	6
18	1020	1260	1470	1640	1770	1860	1930
16	1260	1630	2000	2330	2610	2810	2960
14	1470	2000	2590	3180	3710	4150	4480
12	1640	2330	3180	4120	5050	5900	6590
10	1770	2610	3710	5050	6540	8030	9380
8	1860	2810	4150	5900	8030	10400	12770
6	1930	2960	4480	6590	9380	12770	16540

† Solenoid Model: 24 Vac Pressure: 150 psi Voltage Drop: 4 V Min. Op. Voltage: 20 V Amperage (peak): 0.3A

MULTIPLIER FACTOR FOR VARIOUS CONTROLLER OUTPUT VOLTAGES AND OPTIONAL LOW-VOLTAGE SOLENOIDS

CHART 5

Controller Output Voltage	24-Volt Solenoids		
	24 Vac	24 Vac-D	24 Vdc
28	2.00	5.77	5.45
27	1.75	5.05	4.77
26	1.50	4.33	4.09
25	1.25	3.61	3.41
24	1.00	2.88	2.73
23	.75	2.16	2.05
22	.50	1.44	1.36

CHART 5

Controller Output Voltage	12-Volt Solenoids		
	12 Vac	12 Vac-D	12 Vdc
16	.58	2.50	1.96
15	.50	2.08	1.63
14	.41	1.67	1.30
13	.33	1.25	.98
12	.25	.83	.65
11	.17	.42	.33

TORO LIMITED WARRANTY FOR IRRIGATION PRODUCTS

The Toro Company and its affiliate, Toro Warranty Company, pursuant to an agreement between them, jointly warrants to the owner each new piece of irrigation product (featured in the current catalog at date of installation) against defects in material and workmanship for a period described herein, provided they are used for irrigation purposes under manufacturer's recommended specifications.

During the warranty period, we will repair or replace, at our option, any part found to be defective. Your remedy is limited solely to the replacement or repair of defective parts. This warranty does not apply (i) to Acts of God (e.g., lightning, flooding, etc.) unless specifically listed under the Extended Lightning Protection Warranty provided herein; or (ii) to products not manufactured by Toro when used in conjunction with Toro products; or (iii) where equipment is used or installation is performed in any manner contrary to Toro's specifications and instructions, or where equipment is altered or modified; or (iv) to natural infestations (e.g., insects, rodents, etc.).

Return the defective part to your irrigation contractor or installer, or your local distributor who may be listed in your telephone/web directory under "Irrigation Supplies" or "Sprinkler Systems", or contact:

The Toro Warranty Company
5825 Jasmine Street, Riverside,
California, 92504,
phone (877) 345-8676

For the location of your nearest Toro distributor, or outside the U.S., call (951) 688-9221.

Neither Toro nor Toro Warranty Company is liable for indirect, incidental or consequential damages in connection with the use of equipment, including but not limited to vegetation loss, the cost of substitute equipment or services required during periods of malfunction or resulting non-use, property damage or personal injury resulting from installer's actions, whether negligent or otherwise. Some states do not allow the exclusion of incidental or consequential damages, so this exclusion may not apply to you.

All implied warranties, including those of merchantability and fitness for use, are limited to the duration of this express warranty. Some states do not allow limitations on how long an implied warranty lasts, so this limitation may not apply to you.

This warranty gives you specific legal rights and you may have other rights, which vary from state to state.

STANDARD WARRANTY

Toro Irrigation Business products are covered by this warranty for a period of two years from the date of installation, except as otherwise noted.

EXTENDED THREE-YEAR WARRANTY

The following products are covered by this warranty for three years from date of installation: DDC™ WP Controller.

EXTENDED FIVE-YEAR WARRANTY

The following products are covered by this warranty for five years from date of installation:

Fixed Sprays: All 570Z Series Spray Bodies;

Rotors: T5, T7, TS90, 640 Series, TS120, TS170 and T-P2;

Valves: EZ-Flo® Plus, TPV, P-220 and 220 Brass Series;

Controllers: EVOLUTION®, TMC-424E, Custom Command™ and TDC Series, AC and DC Decoders

Sensors & Accessories: TWRS Wireless RainSensor™ Series (receiver and transmitter), Smart Connect®, EVO-WS, EVO-AR, EVO-HH, SMRT-T.

SENTINEL® SERIES PRODUCT WARRANTY

All Sentinel Centrals, with the exception of centrals covered by the Toro National Support Network (NSN®), and Sentinel hand-held remotes are covered by this warranty for a period of two years from date of installation. All Sentinel Series satellites are covered by this warranty for a period of five years from date of installation.

LANDSCAPE DRIP WARRANTY

Warranty period from date of delivery:

DL2000™ Series Dripline

- Emitters – 2 years
- Hose – 5 years (prorated)
- Rootguard – 7 years

Drip In® Series Dripline

- Emitters – 2 years
- Hose – 5 years (prorated)

Blue Stripe® Hose

- All – 7 years (prorated)

Fittings

- All – 1 year

Emission Devices

- All (except NGE) – 1 year
- NGE® Emitter and Drip Bubblers – 2 years

Filters and Components

- All – 1 year

Other Accessories

- All – 1 year

GROUNDING

The Toro Warranty for Irrigation Controllers is void if controller is not properly grounded per instruction manual. A good ground source is a mandatory component of overall surge protection for Toro Irrigation Control Systems. Grounding electrode(s) should be placed at each automatic controller or controller group locations. The resistance to the grounding electrode should not exceed 10 Ohms when measured with a Megger Earth Resistance Testing instrument or equivalent. It is the responsibility of the installer to connect all electronic irrigation equipment for which he is responsible to earth ground in accordance with Article 250 of the National Electrical Code (NEC). Even with optimum grounding, neither Toro nor Toro Warranty Company are liable for product failures due to acts of God (i.e., lightning, flooding, etc.), and these failures are not covered by warranty.



IRRITROL® LIMITED WARRANTY FOR IRRIGATION PRODUCTS

CONDITIONS AND PRODUCTS COVERED

Irritrol® warrants to the owner against defects in material and workmanship for the warranty period listed below. This warranty covers the cost of parts and labor only.

The following time periods apply from the original date of purchase:

PRODUCT	WARRANTY PERIOD
Irritrol Turf Products	5 years**
Rain Master® Controllers	5 years**
Rain Master Laguna Software.....	90 days
iCentral™ cards.....	90 days
All other Rain Master Products.....	2 years**

**During the first year of the warranty period, we will exchange any defective product for a replacement product. During years two through five of the warranty period, we will repair or replace, at our option, any part found to be defective.

INSTRUCTIONS FOR OBTAINING WARRANTY SERVICE

Return the defective product and proof of purchase (postage paid) to the place of purchase or to the Irritrol repair facility at:

5825 Jasmine Street, Riverside, California, 92504

FOR ADDITIONAL ASSISTANCE, CALL:

Irritrol Technical Services: 1-800-634-8873

Irritrol Controller Repair: 1-800-899-2058

Rain Master Control Systems: 1-800-777-1477

ITEMS AND CONDITIONS NOT COVERED

Irritrol is not liable for failure of products not manufactured by it even though such products may be sold or used in conjunction with Irritrol products.

This warranty does not apply to loss or damage to the product if the damage is caused by service performed by a party other than Irritrol, if the product is used or if installation is performed in any manner contrary to Irritrol's specifications and instructions, or due to any other abuse, alteration, modification, mishandling, or accident. You must pay transportation costs and costs to return the product to us.

GENERAL CONDITIONS

Our liability is limited solely to the replacement or repair of defective parts. There are no other express warranties.

IRRITROL IS NOT LIABLE FOR INDIRECT, INCIDENTAL, OR CONSEQUENTIAL DAMAGES IN CONNECTION WITH THE USE OF PRODUCT, INCLUDING BUT NOT LIMITED TO: VEGETATION LOSS, THE COST OF SUBSTITUTE PRODUCT OR SERVICES REQUIRED DURING PERIODS OF MALFUNCTION OR RESULTING NON-USE, OR PROPERTY DAMAGE OR PERSONAL INJURY RESULTING FROM INSTALLER'S NEGLIGENCE. ALL IMPLIED WARRANTIES, INCLUDING THOSE OF MERCHANTABILITY AND FITNESS FOR USE, ARE LIMITED TO THE DURATION OF THIS EXPRESS WARRANTY.

Some states do not allow the exclusion or limitation of incidental or consequential damages, so the above limitation or exclusion may not apply to you. Some states do not allow limitations on how long an implied warranty lasts, so the above limitation may not apply to you.

This warranty gives you specific legal rights and you may have other rights which vary from state to state.





Irritrol[®]

TORO.COM/IRRIGATION
877-345-8676

IRRITROL.COM
800-634-8873

© The Toro Company 2022. We reserve the right to improve our products and make changes in the specifications and designs without notice and without incurring obligation. Products depicted in this brochure are for demonstration purposes only. Actual products offered for sale may vary in design and features. PN: 22-1020-DB-NA