



University

Electrical Systems

**Principles, Circuits, Schematics,
Test Equipment, and Components**

This page is intentionally blank.

Table of Contents

Introduction..... 2

Electrical Principles 4

Basic Circuits..... 5

Schematics 8

Testing Tools 10

Circuit Testing..... 15

Components 19

Introduction

Electricity plays an important role in modern turf equipment



Electricity plays an important role in modern turf equipment. Modern 12 volt electrical systems are used almost exclusively in turf equipment.

The demands on the electrical system include: starting, lighting and ignition systems. Electrical circuits control the operation of the machines and monitor certain machine functions. They enhance the overall operation and also improve the operators safety, through various safety circuits. New methods to control the operation and the function of the machine are made possible because of electrical devices.

Microprocessor Controls



With the use of microprocessor based controls, the potential of electrical and electronic circuits and controls will greatly change the ease of operation and the reliability of current and future equipment.

These new advances in electrical systems will require a better understanding of electricity and complete electrical systems, to enable technicians to diagnose and repair these systems.

**Safety**

While the risk of electrical shock is relatively low when working on a 12 volt electrical system, care must be taking when working on equipment electrical systems.

Fumes from battery electrolyte are flammable.

Keep all sparks and fires away from the battery. When charging the battery, explosive fumes are produced more rapidly. Be sure the room or area where batteries are being recharged is well ventilated.

Battery acid is harmful on contact with the skin or

most materials. If acid contacts the skin, rinse the affected area with running water for 10 to 15 minutes. If acid contacts the eyes, force the eyelids open and flush the eyes with running water for 10 to 15 minutes. Then see a doctor at once.

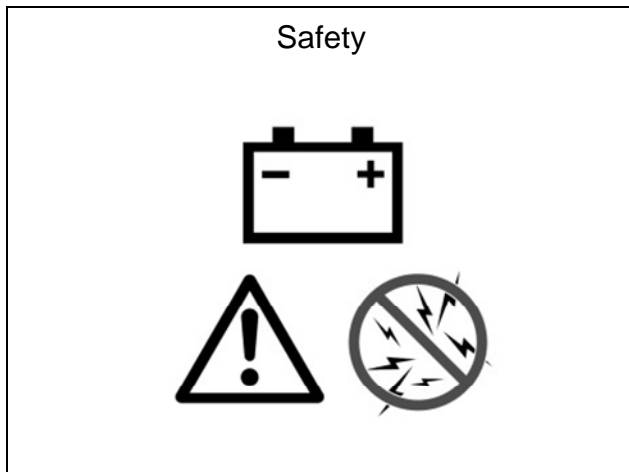

To avoid injury from sparks or short circuit, **Disconnect the negative battery ground cable** when working on any part of the electrical system.

Remove all Jewelry and watches when working on live circuits.

Injury can result from high temperature caused when jewelry, rings or watches come in contact with powered circuits and ground circuits.

When removing batteries always disconnect the negative battery cable first. When reconnecting the battery wait until last to connect the negative cable.

Do not lay tools or parts across the battery, the metal parts or tools can short across the battery posts and a fire or explosion can result.

Electrical Principles

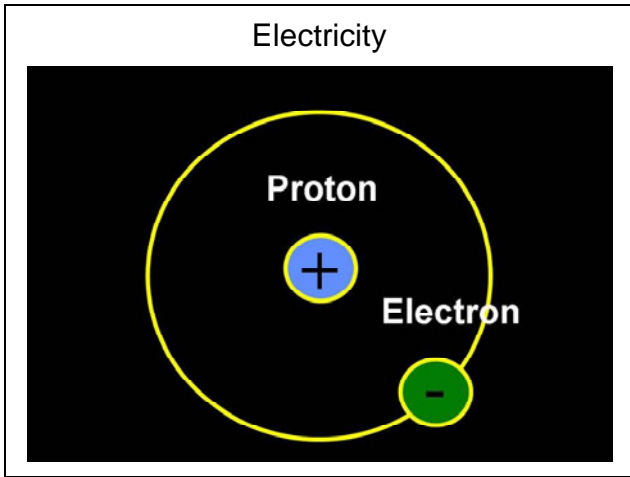

Electricity

Electricity is a form of energy created by the movement of electrons. Directing these electrons through a circuit, we can perform work. Electricity can produce light, heat, magnetism or mechanical work.

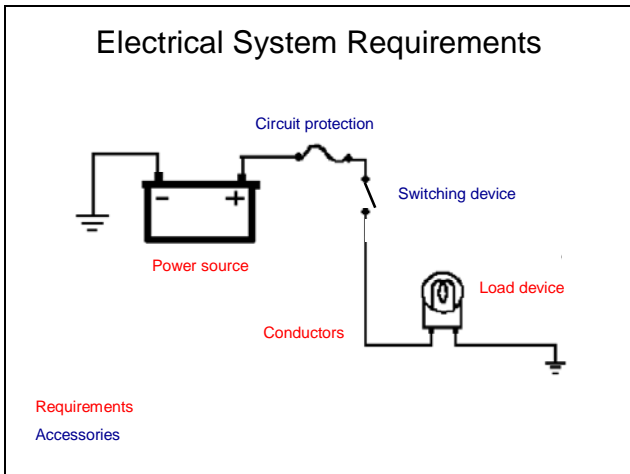

Basic System Requirements

Every electrical system requires 3 basic components and usually 2 accessory components.

- Power Source
- Load Device
- Conductors "Accessory Components"
- Switch
- Fuse

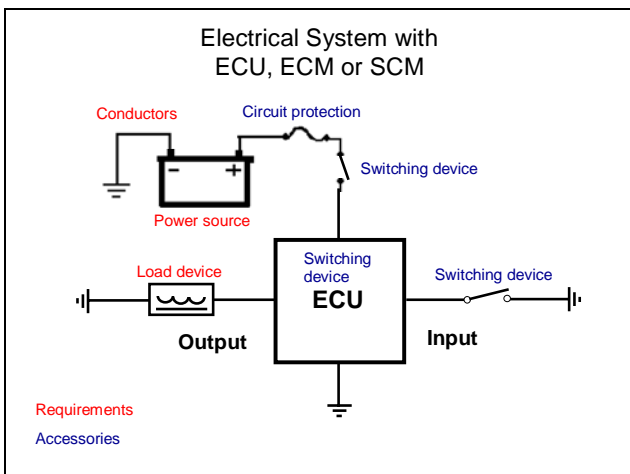

Here are the same basic requirements on a machine equipped with an Electronic Control Unit, Electronic Control Module or Standard Control Module. The ECU/ECM/SCU acts as a switching device, replacing multiple relays. The device looks at inputs (switches), and based on the condition of those inputs, turns on and off various outputs.

Basic Circuits

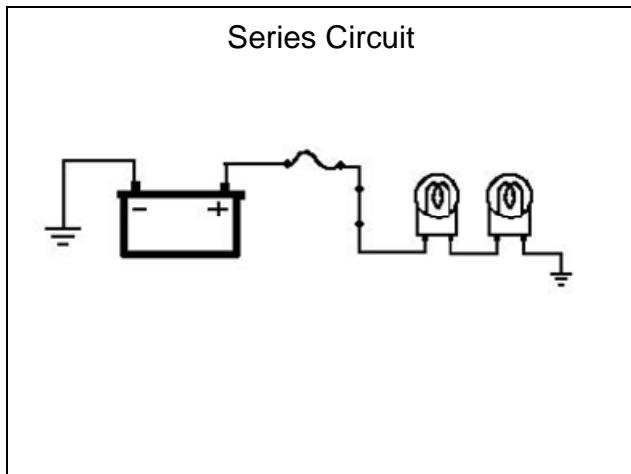

Series Circuit

A series circuit is a circuit that may include more than one load.

Characteristics of a series circuit:

- 1: The current is constant through out the circuit.
- 2: The current must pass through each component in the circuit.
- 3: The total resistance of the circuit controls the current in the circuit.
- 4: The total resistance of the circuit is the sum of all the resistance's in the circuit.
- 5: The sum of the voltage drops across the resistors will equal the applied voltage.

Resistance in a series circuit equals the sum of all resistance's (that is, $R = R_1 + R_2 + R_3 + \text{etc...}$)

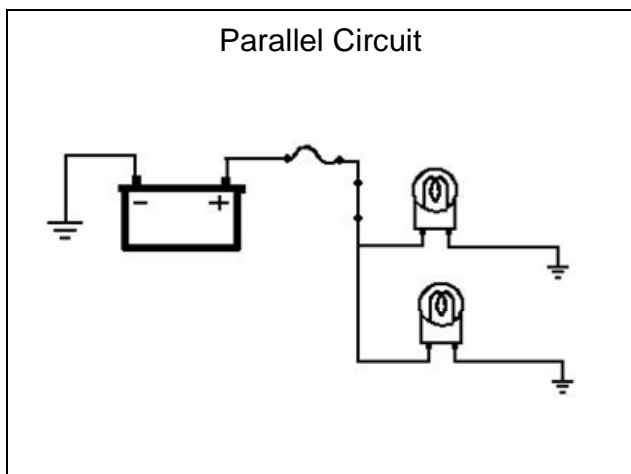

Parallel Circuits

A parallel circuit is a circuit that has two or more loads connected so that current can divide and flow through the load. Most electrical circuits are parallel.

Characteristics of a parallel circuit:

- 1: The current has many paths.
- 2: The resistance in each load will determine the current flow for that resistance.
- 3: The total resistance will always be less than the smallest resistance in the circuit.
- 4: The voltage drop across all loads will be battery voltage.

The formula for calculating resistance in a parallel circuit is:

$$R = \frac{R_1 \times R_2}{R_1 + R_2}$$

Element	Unit	Symbol	Test Device
Voltage (Pressure)	Volts	V	Voltmeter
Current (Flow)	Amperes	A	Ammeter
Resistance (Backpressure - resistance to flow)	Ohms	Ω	Ohm meter

Basic Electrical Elements

Current is the directed flow of electrons through the circuit.

Voltage is the electrical pressure that causes the electrons to flow.

Resistance is a restriction to current flow.

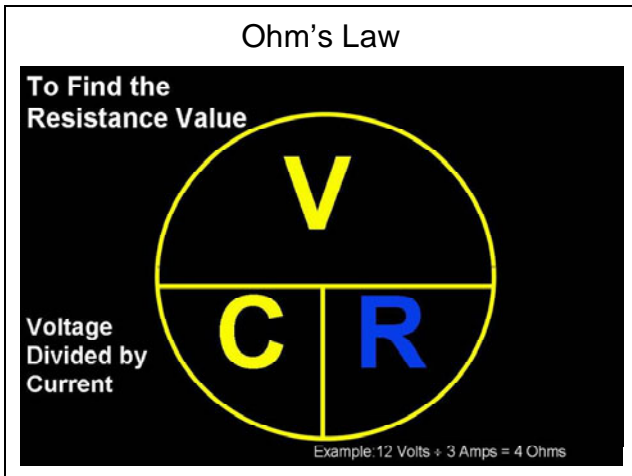

The three electrical elements have a direct effect on each other. The formula to calculate this effect is Ohms Law.

The illustration at the right is Ohms law. The letters represent the properties in the system.

V = Voltage,
C = Current,
R = Resistance.

(Hint: remember VCR.)

If you know any two of the values you can apply the proper mathematical formula and find the third.

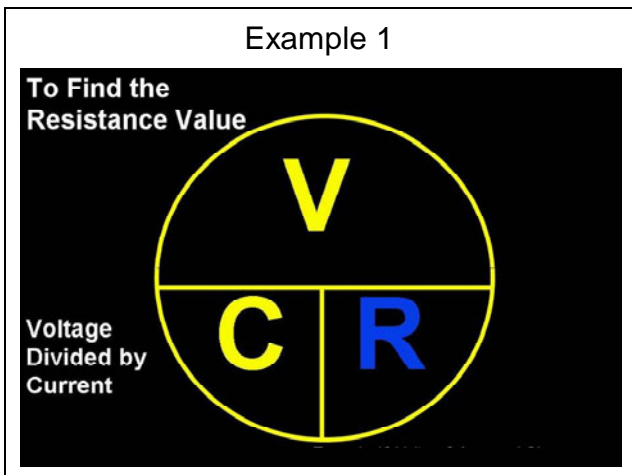

Lets apply Ohms Law to a circuit

A starter motor for a WORKMAN 3200 Gas draws 90 amps when the system is operating correctly. Since we know the voltage and the current, we find the resistance by taking the voltage and dividing it by the current. $12.5 \text{ volts} \div 90 \text{ amps} = 0.135 \text{ Ohms}$

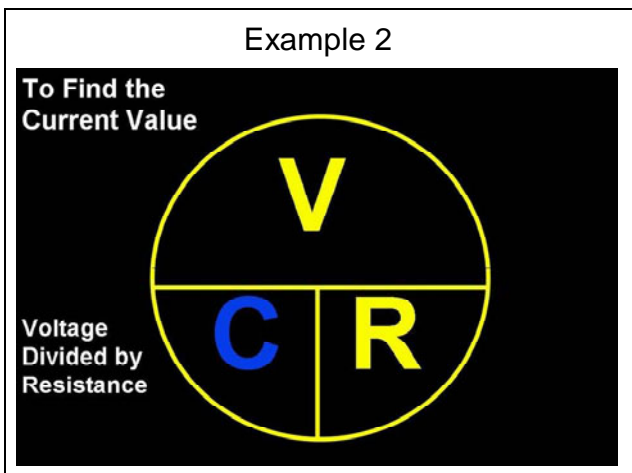

If we INCREASE our system resistance to 0.2A, what will happen to our current flow? $12.5 \text{ volts} / 0.2A = 62.5 \text{ amps}$. An increase in our system resistance will decrease the current flow in our circuit. This will result in what symptom?
(Answer = slow crank or no start.)

What happens if we DECREASE our starting system resistance to 0.04A? $12.5 \text{ volts} / 0.04A = 312.5 \text{ amps}$. This will result in what symptom?
(Answer = slow crank or no start.)

How can higher resistance cause the same symptoms as lower resistance? With higher resistance, the amount of current flowing to the starter is limited by the additional resistance in the circuit. In the case of lower resistance, the only way to lower resistance in a circuit is to provide a shorter or alternate path to ground. That means that a portion of the amperage flow is taking a different path to ground than originally intended. the result is actually a lower power output from the starter.

Electrical Schematics

Accurate diagrams of electrical circuits are essential to the technician who must repair it. If you don't understand how the system operates, it is very difficult to diagnose possible electrical problems.

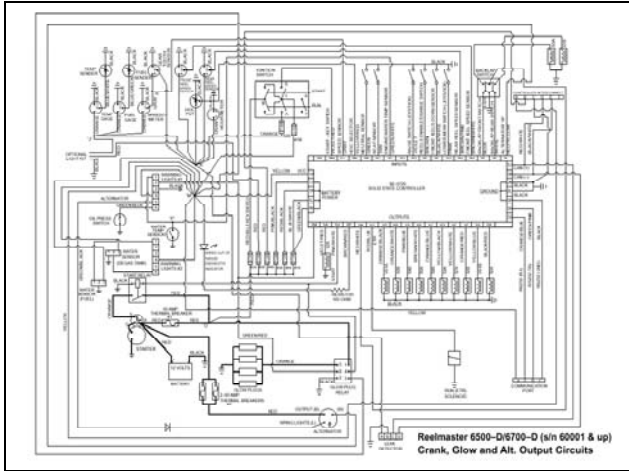

Let's start with something simple . . . don't worry, it's not that complicated.

The key to understanding complex schematics is to break them down into their individual circuits. If you are troubleshooting a no crank problem, you don't need to be looking at the cutting unit or lift circuits.

This schematic is from the Reelmaster 6500/6700-D Service Manual. As you can see, in the Service Manual, we provide a information on what circuits are energized in different modes of operation to make the schematic easier to understand.

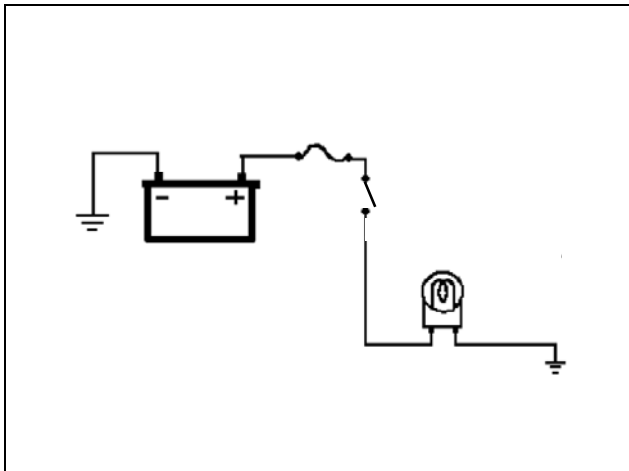

Schematic Circuit Diagrams, rather than wiring harness diagrams are usually preferred for troubleshooting, because of their ability to show current and potential system functions. A schematic diagram is made up of consistent geometric symbols for the components, and their controls and connections.

Let's identify some of the symbols we use in Toro electrical schematics.

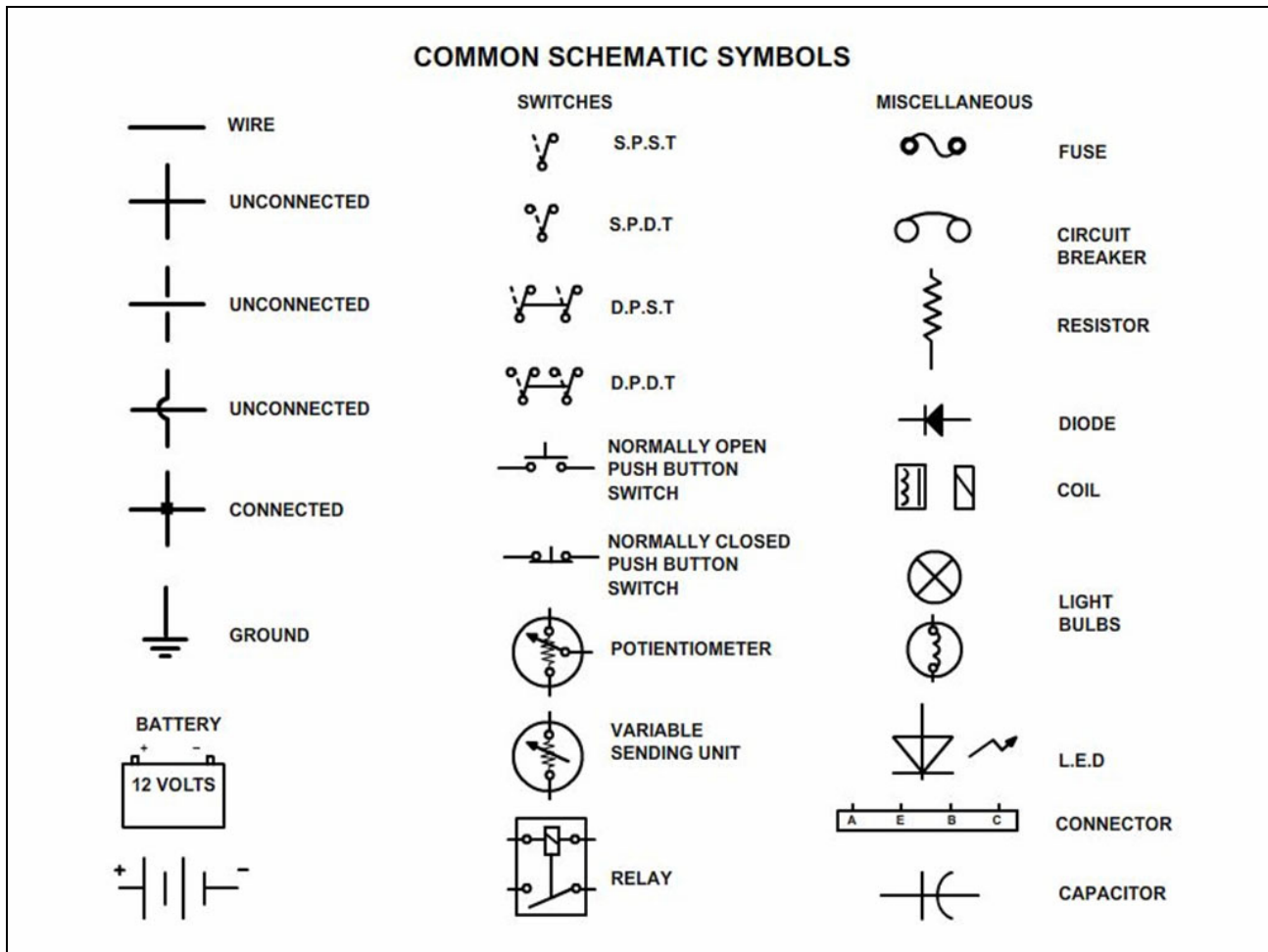

Electrical Testing Tools

Test Lights



Test lights

Features:

1. Used for checking for power in a circuit.
2. Can't give actual voltage readings.
3. Should not be used on electronic circuits

Digital Multimeter



Digital-Volt-Ohm meter (DVOM)

Features:

1. Voltage (Pressure) testing.
2. Amperage (Flow) testing.
3. Resistance (Restriction) testing.
4. Diode (Check valve) testing.

Many of these meters are auto-ranging.

Digital multimeters are high impedance to protect sensitive circuitry.

Diagnostic Display Tool



The diagnostic display tool is used to check inputs on machines equipped with an electronic control module (ECM) or electronic control unit (ECU). On some machines this tool can also be used to locate output faults.

Electrical System Problems

- Understand the system
- Talk to the operator
- Identify the problem
- Try to repeat the problem
- List possible causes
- Test the most likely cause
- Make repairs before doing more tests

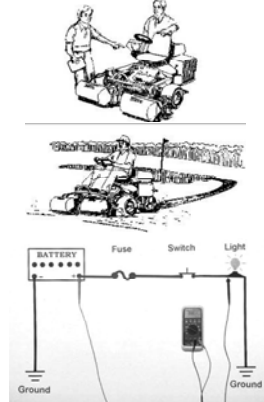

When troubleshooting an electrical problem:

1. Know the electrical system for the machine:
Study the schematics, Operators Manual and Service Manual.

Know how the system works and what voltage and resistance measurements you should find.

2. Talk to the operator:

How did the machine act just as it started to malfunction?

Was any “do-it-yourself” service performed or did anyone else attempt to repair the machine?

How was the machine used and when was maintenance last performed?

3. Operate the machine:

Operate the machine in conditions simulating when the malfunction occurred. Verify what the operator described.

Are the gauges and warning lights operating correctly.

Check for any unusual operation, sounds, smells, or smoke. When during the operating cycle does this occur.

4. Inspect the machine:

Check for bypassed safety interlock switches or other components.

Check the battery. Is it fully charged? Are the terminals corroded?

Look for corroded, loose or damaged wires and connections, including ground connections.

5. List possible causes:

Note what was reported by the operator and verified by you.

List what you found during your inspection.

Remember that there may be more than one cause leading to the failure or malfunction.

6. Determine which cause is most likely the problem:

Look at your list of most possible causes and determine which are the most likely. Use the troubleshooting charts in the Service Manual.

7. Test your findings

Operate the system with a volt-ohm multi-meter connected to the suspected malfunctioning circuit.

Use the diagnostic lamp's) and/or diagnostic display if the unit is equipped with an electronic control system (ECU/ECM/SCM). It may be necessary to

replace or adjust a component to verify your findings.

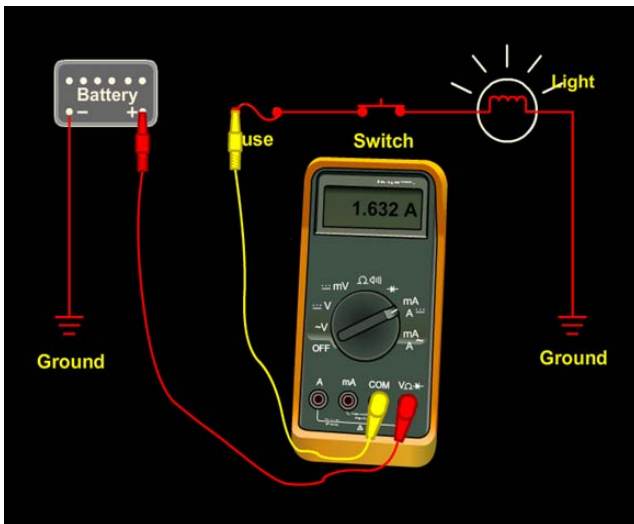

Multi-meter Uses

Measuring **Current** with an Ammeter

Set meter to Amps
 Open circuit and connect meter in series
 Close switch and activate circuit
 Read amperage on meter.

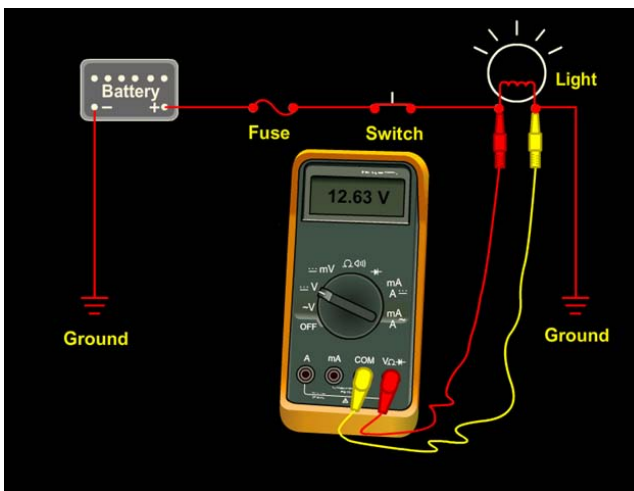

Measuring **Voltage** with a Voltmeter

Set meter to DC volts
 Connect meter across load
 Close switch and activate circuit
 Read voltage on meter.

Measuring Voltage



Measuring voltage across the terminals on a component (lamp).

Measuring Resistance



Measuring Resistance With an Ohmmeter

Isolate the load from the circuit.
 Connect meter across load.
 Read resistance on meter.

Clamp Meter (Ammeter)



High Amperage Circuit Testing

Generally, testing electric circuits over 10 amps will exceed most multimeter's capacity. A clamp meter can test high amperage circuits without having to disconnect any wires.

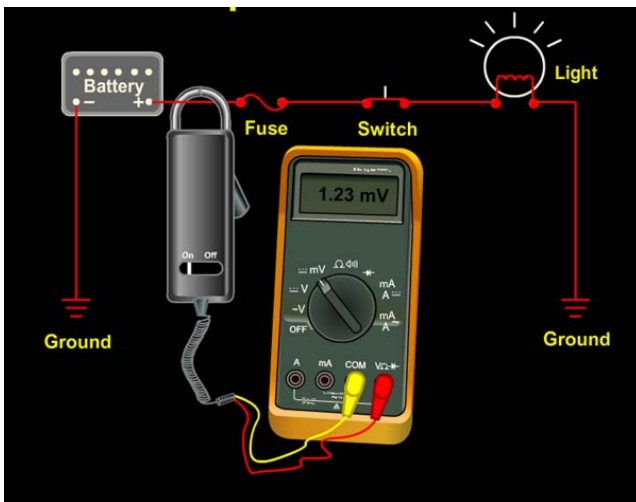

Measuring current with clamp on ammeter

Clamp meter around wire.
 Activate system.
 Read amperage on meter.

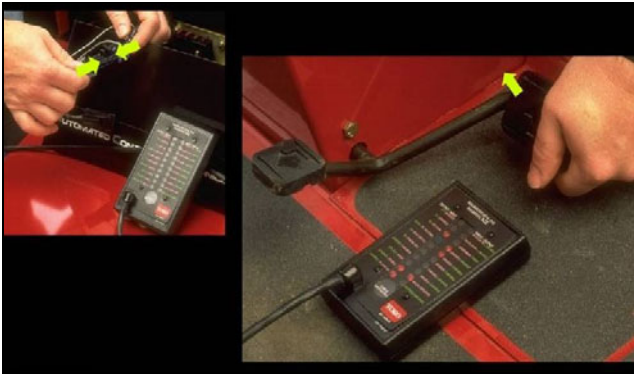

Checking inputs with the diagnostic display tool.

Connect the tool the loop-back connector at the ECU or ECM.

Turn the key on.

Check to see that each input activates the appropriate LED's on the tool (input switch opens and closes).

In this case we are checking the transmission neutral switch. The LED should be on when the traction pedal is in neutral and off when the traction pedal is moved to forward or reverse.

Basic Circuit Testing

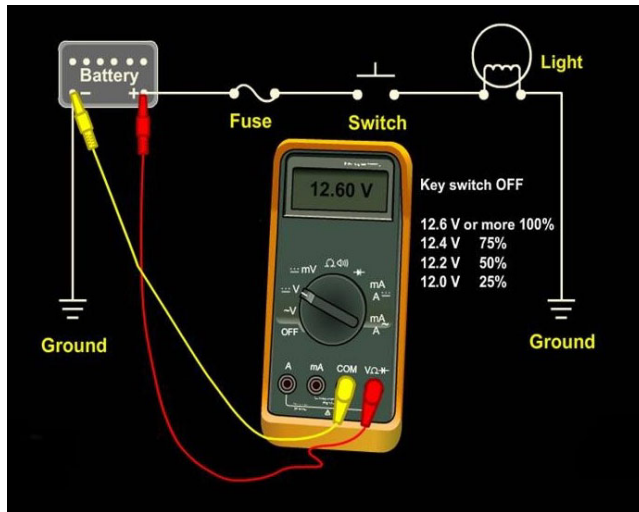

Basic Circuit Testing

Voltmeter testing

When testing for voltage we connect a voltmeter to the positive and negative post of the battery, we should read 12.6 volts. With the key switch off. With the engine running the meter should read 13.6 volts or more (at least 1 V more than battery voltage.)

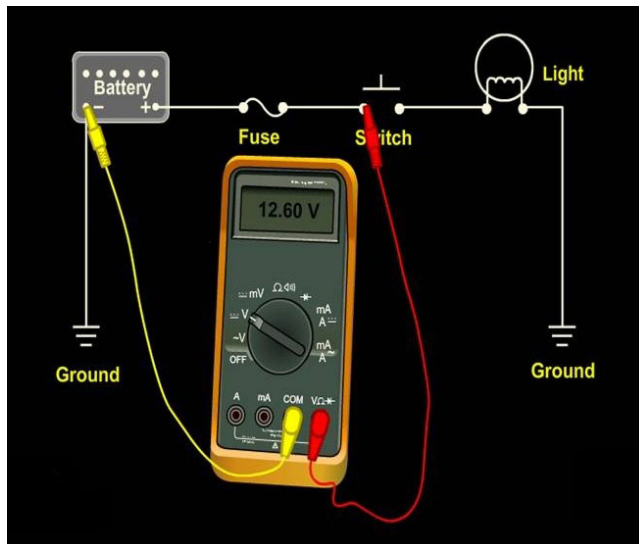

If we connect our voltmeter to the negative post of the battery and to any point up to the switch, we will still measure 12.6 volts. All we are measuring is the voltage available up to the switch.

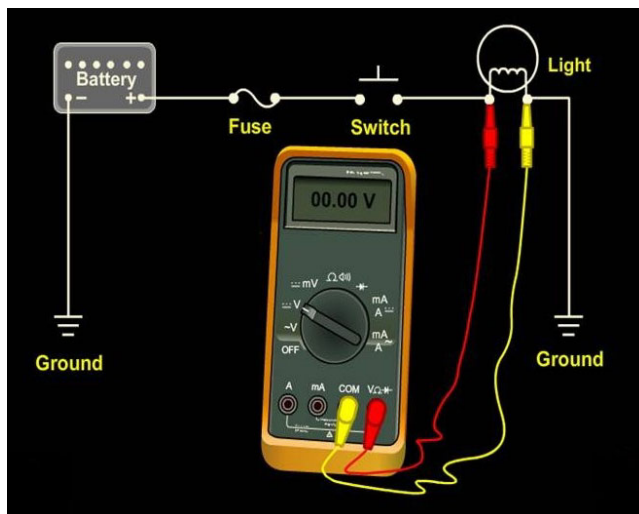

Connecting the voltmeter across the load with the switch open will show a voltage reading of 0.0 volts. Without the switch closed, (no current flowing in the circuit) there is no voltage difference across the load.

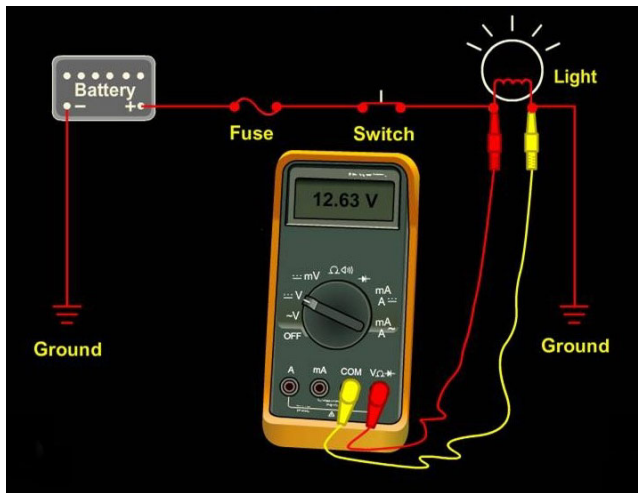

When we close the switch, current flows in the circuit. We will then read a voltage drop (pressure difference) across our load. There must be current flowing in the circuit to measure the voltage difference across the load.

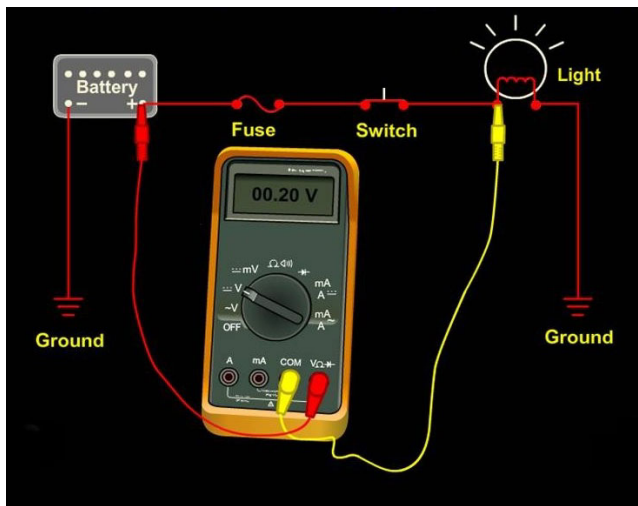

Understanding voltage drop testing and when to perform a voltage drop test.

When you encounter poor performance from an electrical component. A test of the circuit may indicate that the amperage flow is lower than required to operate the system. The area of excessive resistance must be located and repaired. Performing a voltage drop test will help locate the area of excessive resistance.

Testing for voltage drop

Connect the voltmeter red lead (+) to the power (or “most” positive) side of the component, circuit or connection to be tested.

Connect the voltmeter black lead (-) to the ground (or “least” positive) side of the component, circuit or connection to be tested.

Set the meter scale to exceed the expected test voltage. (Auto-range on digital voltmeters).

Turn “on” the circuit, (remember, current must be flowing through the circuit for resistance to be found) and read the voltage.

Voltage Drop Testing (Feed Side)



Here we are testing the voltage drop between the battery and starter solenoid.

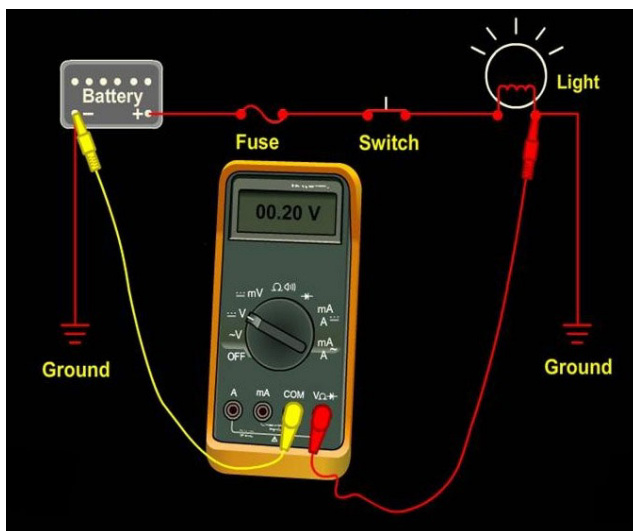

This illustrates a “ground side” voltage drop test. Remember, there must be a complete circuit for the system to work. A faulty or corroded ground side circuit can cause problems as well.

Voltage Drop Testing

High Amperage Circuit (> 20 A)	Low Amperage Circuit (< 20 A)
0.4 Volts feed side	0.2 Volts feed side
0.4 Volts ground side	0.2 Volts ground side

Voltage drop testing can isolate areas in a circuit where undesirable resistance is present. It is an important test for both low and high amperage circuits. See table for maximum voltage readings when testing circuits.

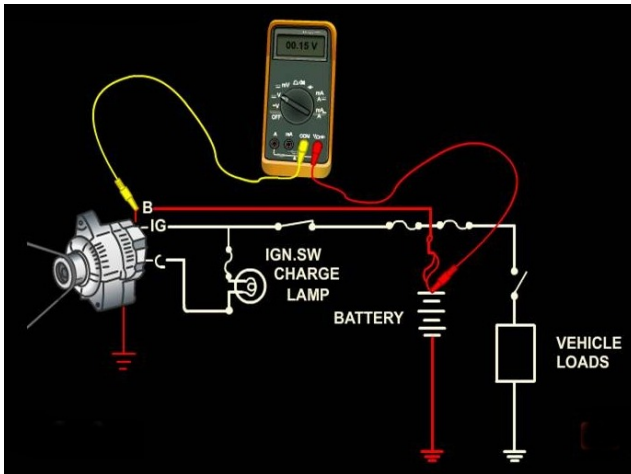
**Example:****Feed Side Voltage-Drop Test (engine must be running)**

Alternator output terminal (B+) to battery positive post

Can detect excessive resistance

Less than 0.2 V

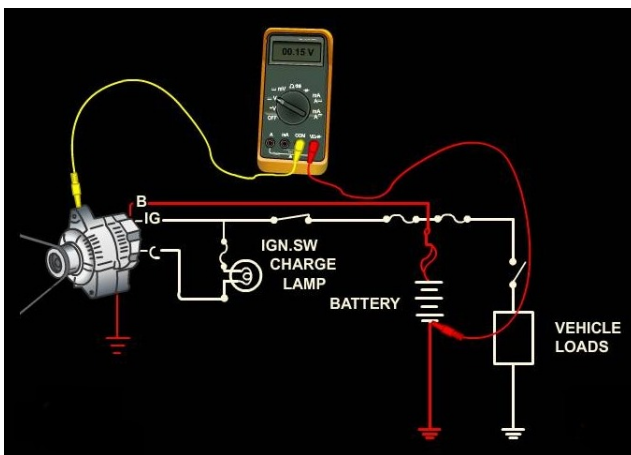
**Ground Side Voltage-Drop Test**

Alternator Case to battery negative post

Can detect excessive resistance

Less than 0.2 V

Diagnostic Tips:

Tools you need to effectively diagnose electrical performance issues:

- Knowledge & understanding
- An electrical performance problem
- DVOM
- Ammeter (current sensing device)

What to check:

- Is current flow higher or lower than expected?
- Check the supply
- Activate the circuit and do voltage drop tests
 - Check the feed side
 - Check the ground side
- If the above tests check out, then suspect the load device itself.

These test procedures are non-invasive. You do not need to open a circuit for testing. You can isolate out the high resistance problems with confidence!

Electrical Components

Let's look at components and the testing of the components.

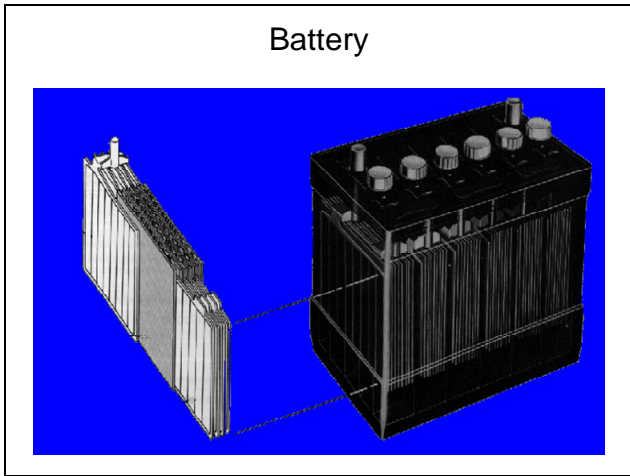

Battery

A battery is an electrochemical device that can store electrical energy.

Caution: Gas vapor from a battery is flammable. Keep all sparks and flames away from a battery or an explosion can occur.

Battery

TEST	TEST RESULTS	CONDITION	CORRECTIVE PROCEDURE
SPECIFIC GRAVITY TEST @ 80° F	GRAVITY BELOW 1.250 - 1.280	CHARGED	PERFORM LOAD TEST
	GRAVITY BELOW 1.240	DISCHARGED	RECHARGE PERFORM LOAD TEST
	MORE THAN 50 GRAVITY POINTS (0.050) VARIATION BETWEEN CELLS	(A) SHORTED CELL (B) ACID LOST (C) OLD BATTERY	REPLACE
LOAD test (15 seconds)	MINIMUM TERMINAL VOLTAGE **	(A) DISCHARGED (B) OLD BATTERY	(A) RECHARGE (B) REPLACE

There are two basic battery tests

Specific Gravity Test (use table)

The specific gravity or weight of the battery electrolyte indicates state of the battery charge. A battery hydrometer measures the specific gravity of the electrolyte. Hydrometers are calibrated to measure specific gravity correctly at an electrolyte temperature of 80°F. To determine the correct specific gravity reading when the temperature of the electrolyte is other than 80°F: **Add** to the hydrometer reading four gravity points (0.004) for each 10°F **above** 80°F. **Subtract** four gravity points (0.004) for each 10°F **below** 80°F.

Amperage load should equal one-half the cold cranking amperage of the battery

3 X Amp-Hr rating for 12-volt batteries

Switches

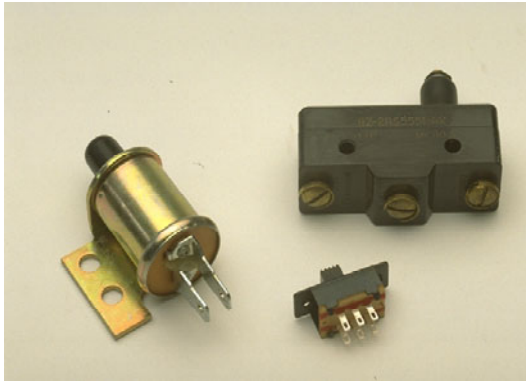

Common Switches

Description:

Manually operated switches that control current flow in the circuit.

Toggle switches
Push button

Commonly used for Neutral, light, horn and seat switches.

Key Switch

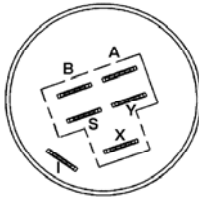

POSITION	CIRCUIT
OFF	NONE
RUN	B + I + A, X + Y
START	B + I + S

Key Switch

Used to control unit starting, running, and accessories.

Testing

Test Switches with an Ohmmeter. Look for continuity when closed, infinity when open.

When the switch is in the circuit, the switch is tested with a voltmeter.

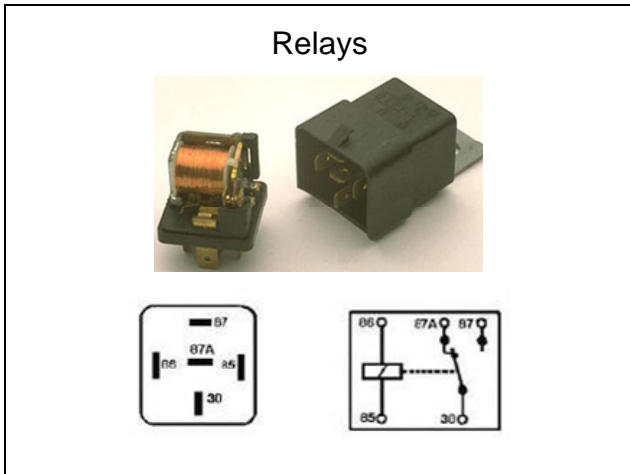

Electromagnetic Switches

Description:

Electrically operated switches that control current flow in the circuit.

Types:

- Relays
- Solenoids

Testing

Relays and solenoids are tested with an Ohmmeter.

Relay test:

Terminal 85 to 86 = 76A or 86A

Terminal 30 to 87A = Normally closed

Terminal 30 to 87 = Normally open (until power is applied to terminal 85 & 86)

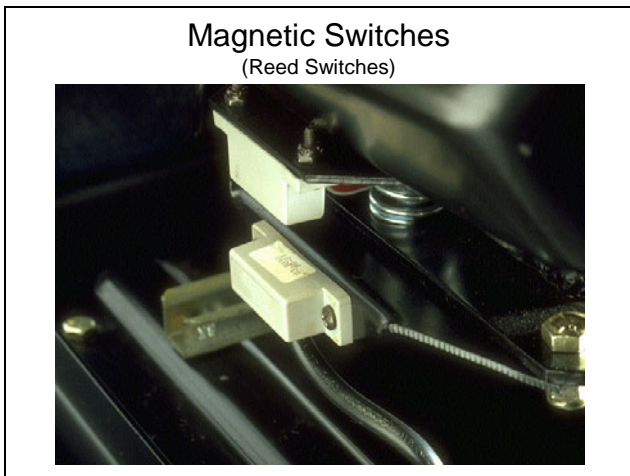

Magnetic Switches (Proximity or Reed Switches)

Description:

Magnetically operated switches that control current flow in the circuit.

Types:

- Seat switch.
- Cutting unit lift arm switch.

Testing

Magnetic reed switches are tested with an Ohmmeter and using a magnet to close the switch.

Magnet away from switch, meter reading 0. L. (open)

Magnet close to switch, Meter reading 0.2A (closed)

Sensors

Pressure switch



Temperature Senders



Pressure Switches

Description:

Pressure operated switches that control current flow for lights and gauges.

Types:

Engine oil pressure
Hydraulic oil pressure
Filter restriction senders

Testing

Pressure switches are tested with an Ohmmeter. Look for continuity when closed, infinity when open. They can be normally open and close at a certain pressure, or normally closed and open at a certain pressure.

Temperature Senders and Switches

Description:

Temperature controlled switches and senders.

Types:

Engine coolant temperature switch and sender
Hydraulic system temperature switch and sender

Temperature Senders



Testing Temperature Switches

Temperature switches are tested with an Ohmmeter. With the ohmmeter check if the switch is open or closed. Submerge the sensing bulb in hot water and watch for switch change. (Note: The switch actuation temperature is usually noted on the switch).

Temperature senders are tested with an Ohmmeter. Measure the resistance of the sender, then submerge the sensing bulb in hot water and watch for resistance change.

Speed Sensors

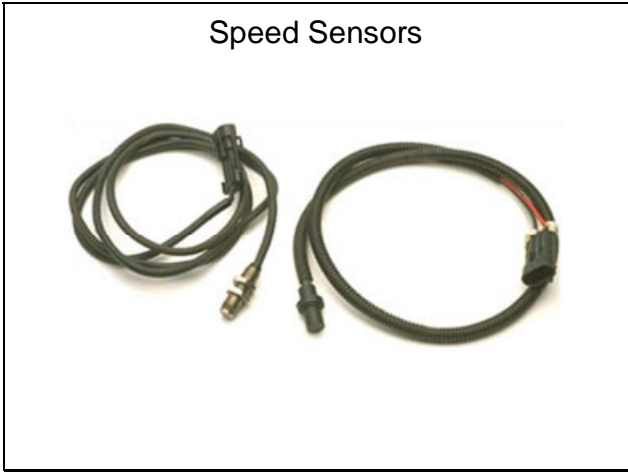

Speed Sensors

Description:

Switches that sense movement or speed. Can be operated by a magnet, or sense a moving shaft.

Types:

- Reel speed sensors
- Ground speed sensors

Testing

Sensors are tested with an Ohmmeter. Connect the ohmmeter and observe the resistance change when the shaft or gear is moved.

Potentiometers

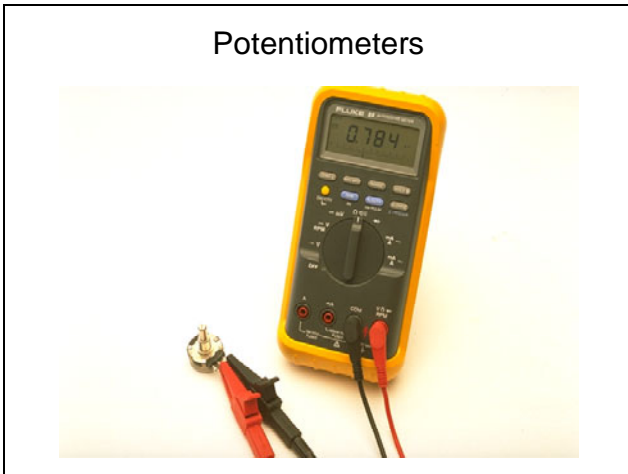

Potentiometers

Description:

Variable resistance switches.

Types:

- Height of cut (H.O.C.) / Reel Speed

Testing

Connecting the Ohmmeter to the two outside terminals will show the total potentiometer resistance. Connecting the Ohmmeter to the center and one outside terminal will show varying resistance when the potentiometer is turned.

Circuit Protection

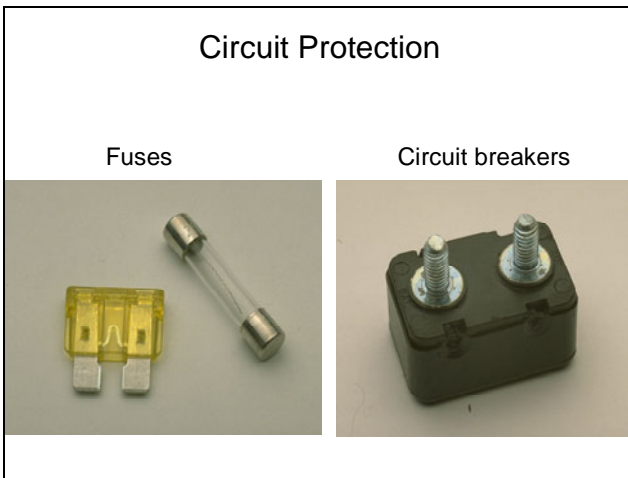

Circuit Protection

Description:

Device that interrupts current flow if current flow becomes excessive.

Types:

- Fuses
- Circuit Breakers

Testing

Fuses and circuit breakers can be checked with an Ohmmeter if disconnected from the circuit, or checked with a voltmeter while in the circuit.

Fusible Links



Fusible Links

Lighter gauge wire than main conductor
 Typically 4 wire sizes smaller
 Covered with special insulation
 Used to protect main circuits

Load Devices

Lights



Glow Plugs



Load Devices

Description:

Device that converts electrical energy to work.

Types:

Lights
 Glow Plugs
 Solenoids
 Motors

Lights can be tested with an Ohmmeter.

Glow Plugs



Glow Plugs

Glow plugs can be tested with an Ohmmeter and the resistance measured. They can also be removed and connected to a 12 volt battery. If the end glows red the plug is OK.

Another way to test glow plugs is to measure the amperage draw of the glow plug circuit. Normal amperage draw is about 10 amps per glow plug.

Solenoids

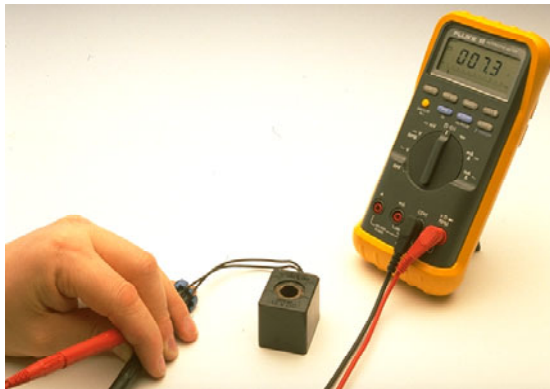

Solenoids

Solenoids are used to control hydraulic valves, fuel injection pumps and some small mechanical functions.

The solenoids can be checked with an ohmmeter or an ammeter. Solenoids can have different size ratings. See the Service Manuals for specifications. For example Reelmaster 5300/5200/5400 machines have 20 and 28 watt solenoids. 20 watt solenoids have a resistance of 7.2A and an amperage draw of 1.66 amps. The 28 watt solenoids have a resistance of 5.1A and a amperage draw of 2.35 amps.

Starter Motor

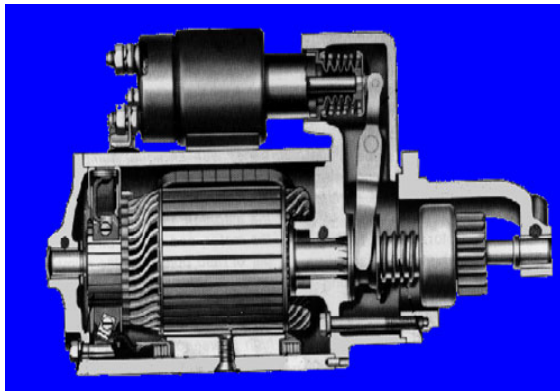

Starter Motors

Description:

Device that converts electrical energy into rotary mechanical energy.

Components:

Drive. Mechanical connection between the starter and the engine.

Armature. Main shaft of the starter that rotates when power is applied to the starter.

Field coil or stationary magnet. Produces the magnetic field to turn the starter.

Starter solenoid (if equipped). Sends the high amperage power to the starter

Testing

The starter can be tested for current draw using an ammeter.

The field coil is tested with an Ohmmeter checking for shorts and continuity.

The armature is tested with an Ohmmeter to check for shorts between the windings and the armature, and to check for continuity of the windings.

Typical starter draw at 65°F (18 C)	
Groundsmaster 223-D	215 A
Groundsmaster 224	110 A
Groundsmaster 325-D	210 A
Groundsmaster 345	75A
Groundsmaster 455-D	230 A
Greensmasters 3000	85A
Reelmaster 223-D/5100-D	215A
Reelmaster 5300-D	250A
Reelmaster 335-D/3500-D	230A
Reelmaster 450-D/4500-D	300A
Workman 3200	90A
Workman 3200-D	170A
Sand Pro 5000	125A
Multi-Pro 1100	80A
Hydroject 3000	110A

Alternators (Stator Type)

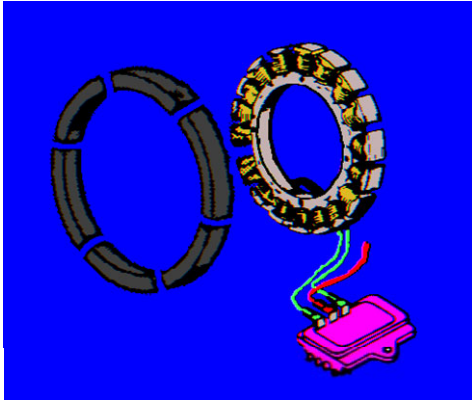

Alternators

Device that produces AC current, then converts this current to DC for equipment functions.

Types:

Stator type, located behind the engine flywheel. This type is found on most air cooled engines.

Problem	Test	Conclusion
No charge to battery	1. Insert an ammeter in between the battery lead and the B+ terminal. Connect a voltmeter from B+ lead to ground. Run the engine at high idle. If voltage is 13.8 volts or higher, and there is no amperage, place a minimum load of 5 amps on the battery to create a load on the system, observe the ammeter.	1. If the charge rate increases when load is applied the charging system is OK and the battery was fully charged. If the charge rate does not increase when a load is applied, test stator and rectifier-regulator. (Test 2 and 3)
	2. Remove the stator wire connector from the rectifier-regulator. With the engine running at high idle, measure AC voltage across the stator leads (lead ac & ac) with an AC voltmeter.	2. If the voltage is equal to the specification in the service manual or greater, the stator is OK. The rectifier-regulator is faulty. Replace the rectifier-regulator. If the voltage is less than specified voltage, the stator is probably faulty and should be replaced. Test the stator further using an ohmmeter (test 3).

Refer to the engine Service / Workshop Manual for specific information. Here is an example of a test procedure for a stator type alternator.

	3a. With the engine stopped, measure the resistance across the stator leads (ac & ac) using an ohmmeter.	3a. If the resistance is equal to the specifications, the stator is OK. If the resistance is 0 ohms, the stator is shorted. Replace stator. If the resistance is infinity ohms, the stator is open. Replace the stator.
	3b. With the engine stopped, measure the resistance from each stator lead to ground using an ohmmeter.	3b. If resistance is infinity ohms (no continuity), the stator is OK (not shorted to ground). If resistance or continuity is measured, the stator leads are shorted to ground. Replace the stator.
Battery Continuously charges at high rate	1. With engine running at high idle, measure voltage from B+ lead to ground using a DC voltmeter.	1. If voltage is 14.7 volts or less the charging system is OK. The battery is unable to hold a charge. Service the battery or replace as necessary. If voltage is more than 14.7 volts, the rectifier-regulator is faulty. Replace rectifier-regulator

Alternator Charging System

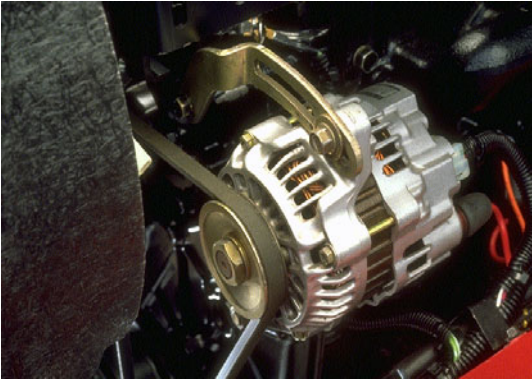

Alternator Assembly

Testing

Alternators can be tested on the machine, on a alternator test bench, or disassembled and the components tested.

Alternators

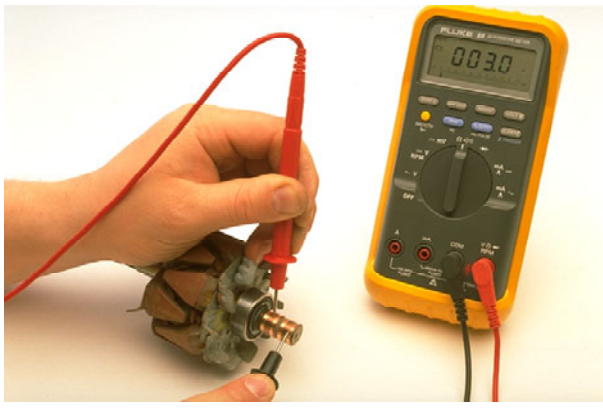

Rotor

The rotor windings should be checked for continuity, connect the ohmmeter leads to both slipper rings.

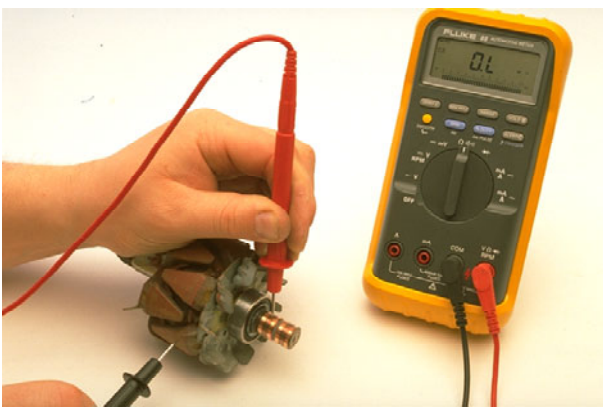

The rotor should be checked for shorts between the windings and the housing. Connect the ohmmeter leads to one slipper ring and the rotor housing.

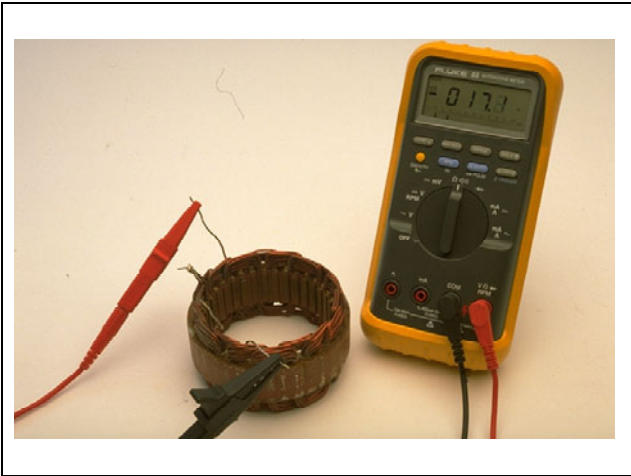

Stator

The stator should be checked for continuity, connect the ohmmeter to the stator windings.



The stator should be checked for shorts, connect the ohmmeter to the stator windings and the housing.

Diodes

DIODE CIRCUIT BOARD

PLUG-IN DIODE

Type	Red (+)	Black ()	Continuity
Circuit Board	H	A	YES
	A	H	NO
	G	B	YES
	B	G	NO
	F	C	YES
	C	F	NO
	E	D	YES
	D	E	NO
Plug-In	1/A	2/B	YES
	2/B	1/A	NO

DIODE CIRCUIT BOARD

Diodes

Description:

Electrical device that allows current to flow in one direction but not the other.

Testing

Diodes can be checked with an Ohmmeter. The meter should show continuity in one direction and open in the other direction. Diodes should be checked with a DVOM with a diode test function.

Example shown is from the Greensmaster 3150 Service Manual.

Ignition Systems

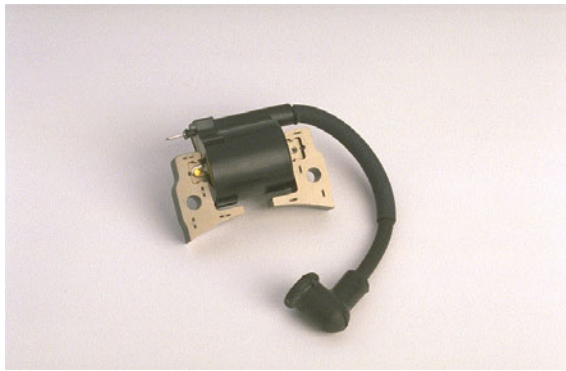

Ignition Systems

Lets look at various types of ignition systems used to operate most gasoline engines.

Ignition systems used in modern turf equipment have a solid state magneto. This type of system uses a solid state module instead of the breaker points. There is a triggering coil within the module, and when the magnets reach a certain point, the triggering coil causes the circuit board to stop the current flow in the primary coil and the high voltage discharge is produced in the secondary coil.

Engines equipped with magneto ignitions are stopped by grounding out the primary coil. This is done through a key switch or a kill switch.

Maintenance

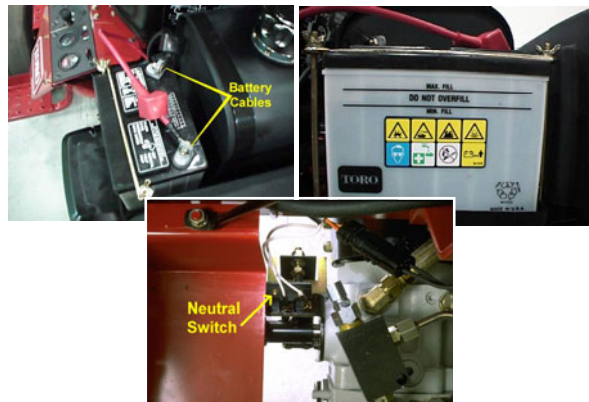

Maintenance

- Check for loose or corroded connections
- Check for damaged wires
- Be careful when washing the machine. Use compressed air, not water, to clean under the control panel
- Keep the battery clean and fully charged

