

The TORO logo is displayed in white, bold, sans-serif capital letters inside a red rounded square.

Outcross™ 9060

TURF UTILITY VEHICLE

FEATURES

Turf-friendliness – The Outcross 9060's unique electronically controlled four-wheel steer and four-wheel drive system provide turf friendliness and maneuverability. Each wheel turns and spins independently for gentle turning and superior traction. Outcross's balanced design removes the need for front counterweights, making it significantly more delicate on fine turf than an agricultural tractor.

Consistency – Set-up and save the parameters for each attachment – one time, upfront – to ensure the machine performs exactly to your specifications. Store settings for up to sixteen attachments for easy use and consistent performance, no matter the skill level of the operator in the seat.

Versatility – The Outcross 9060 will always be on the move. With 3-point, drawbar, cargo bed and loader capabilities, the opportunities to maximize this investment are near endless. The Outcross 9060 does the work of multiple machines in one compact package. Put your investment to work every day and receive consistency, efficiency, and reliability in return.

Control – Operation is simple and intuitive. The Outcross 9060 has a hydrostatic drive system, eliminating the need for an operator who is proficient with the complicated controls and shifting commonly associated with an agricultural tractor. Cruise control, shuttle shifting, a passenger seat, and one-action controls add to the ease-of-use and efficiency.

Do More.

The Outcross 9060 is an invaluable tool in the long-standing battle Turf Managers face to “do more with less.” This machine is a time-saving, easy-to-use, multi-purpose, turf-friendly workhorse that brings year-round flexibility, consistency and productivity to turf maintenance operations. Get ready to do more. The Outcross is the first machine of its kind to be purpose-built for the management of fine turf. Its balanced design, four-wheel steer, and four-wheel drive make it extremely gentle on turf. Keep busy year-round by utilizing Outcross's 3-point hitch, drawbar, or front loader. Mow grass, spread fertilizer, load sand, haul a pallet of sod, aerate, topdress, remove snow and ice, blow leaves, prune roots, spread seed, tow a trailer, sweep a path, chip wood, and much, much more. Intuitive automotive-style controls and one-time parameter setup keeps operations simple and efficient.

toro.com/outcross





Outcross 9060 Specifications

	OUTCROSS 9060 W/ CANOPY	OUTCROSS 9060 W/ CAB	OUTCROSS 9060 W/ LOADER ARMS	OUTCROSS 9060 W/ LOADER ARMS & CAB
ENGINE	Yanmar® 4-cylinder, direct injection, turbo-charged, liquid-cooled diesel. Power: 59 hp (44 kW) gross, @ 3000 rpm. Displacement: 127.6 cu. in. (2.1 L) EPA Tier IV Final Compliant.			
CAPACITIES	Fuel: 14 gallons (53 L) Engine oil with filter: 6.1 quarts (5.8 L)			
ELECTRICAL SYSTEM	12-volt system. Battery: 690 CCA. Alternator: 80 amp.			
TRACTION DRIVE	2-speed hydrostatic			
PTO	Rear independent mechanical up to 540 rpm. Power: 51 hp (38 kW)			
INSTRUMENTATION	InfoCenter™. Onboard LCD displays for attachment parameter setup and to show gauges, alerts/faults, service reminders, electrical system diagnostics. Indicates fuel level, coolant temp, intake temperature, low oil pressure, alternator, engine hours, engine rpm, hydraulic oil temperature, voltage.			
GROUND SPEED/ CLEARANCE	Forward: 14 mph (22.5 km/h) Reverse: 13 mph (20.9 km/h) Ground Clearance: 7" (18 cm)			
HYDRAULICS	Open center			
AUX / REMOTE	12 gpm @ 3000 psi. Standard: 1 hydraulic remote. Optional: second hydraulic remote.			
LENGTH	Front Bumper to 3-point Linkage: 161" (409 cm)		Mounting Plate to Counter Weight End: 202.5" (514 cm)	
WIDTH	With Bed – 77" (195 cm)			
HEIGHT	95" (241 cm)	98" (249 cm)	95" (241 cm)	98" (249 cm)
WEIGHT	5,160 lbs. (2,340 kg)	5,820 lbs (2,640 kg)	5,910 lbs (2,680 kg)**	6,570 lbs (2,980 kg)**
INSIDE TURNING RADIUS	57" (145 cm)			
OUTSIDE TURNING RADIUS	150" (381 cm)			
WHEELBASE	83" (211 cm)			
TIRES	Front: 29.5 x 12.5 (12-ply) Rear: 32 x 16 (12-ply)			
TRACK WIDTH	57.5" (146 cm)			
3-POINT HITCH	Category 2 lift capacity 24" (61 cm) behind lift point: 2,500 lbs. (1,134 kg)			
WARRANTY / CERTIFICATION	Two-year limited warranty. Refer to operators manual for further details. Certified to SAE J2194			
BED DIMENSIONS – (SEE DIAGRAM PAGE 3)				
	Standard Bed		Cargo Bed	
CAPACITY	1,000 lbs. (453.6 kg)		4,500 lbs. (2,041 kg)	
LENGTH	27" (68.6 cm)		52" (132 cm)	
WIDTH, HEIGHT & LOAD HEIGHT (INSIDE)	Width: 73" (185 cm)		Height: 16" (40.6 cm) Load Height: 35" (88.9 cm)	
VOLUME	0.77 cubic yards (0.59 cubic meters)		1.3 cubic yards (0.99 cubic meters)	
FRONT LOADER				
LIFT CAPACITY & LIFT HEIGHT (PIVOT PIN)	Lift capacity: 2,200 lbs. (998 kg) Lift height: 107" (272 cm)			
REACH AT MAX LIFT HEIGHT	33" (84 cm)			
MAXIMUM DUMP ANGLE	70.5 degrees			
REACH OF ATTACHMENT ON GROUND	98.6" (250 cm)			
MAXIMUM ROLLBACK ANGLE	34.8 degrees			
DIGGING DEPTH	7.5" (19 cm) – when bucket is level			
OVERALL HEIGHT	53.5" (136 cm) – in carry position			
SQUARE BUCKET WIDTH / STRUCK CAPACITY	73" (185 cm) / 0.45 cubic yards (0.34 cubic meters)			

*Specifications and design subject to change without notice. Products depicted in this literature are for demonstration purposes only. Actual products offered for sale may vary in design, required attachments and safety features. Consult your local Toro Distributor. Refer to Operator's Manual for further information and instructions.

**Without loader attachment and recommended 1,800 lbs. (816.5 kg) rear counter weight





Outcross[®] 9060 Dimensions^{*}

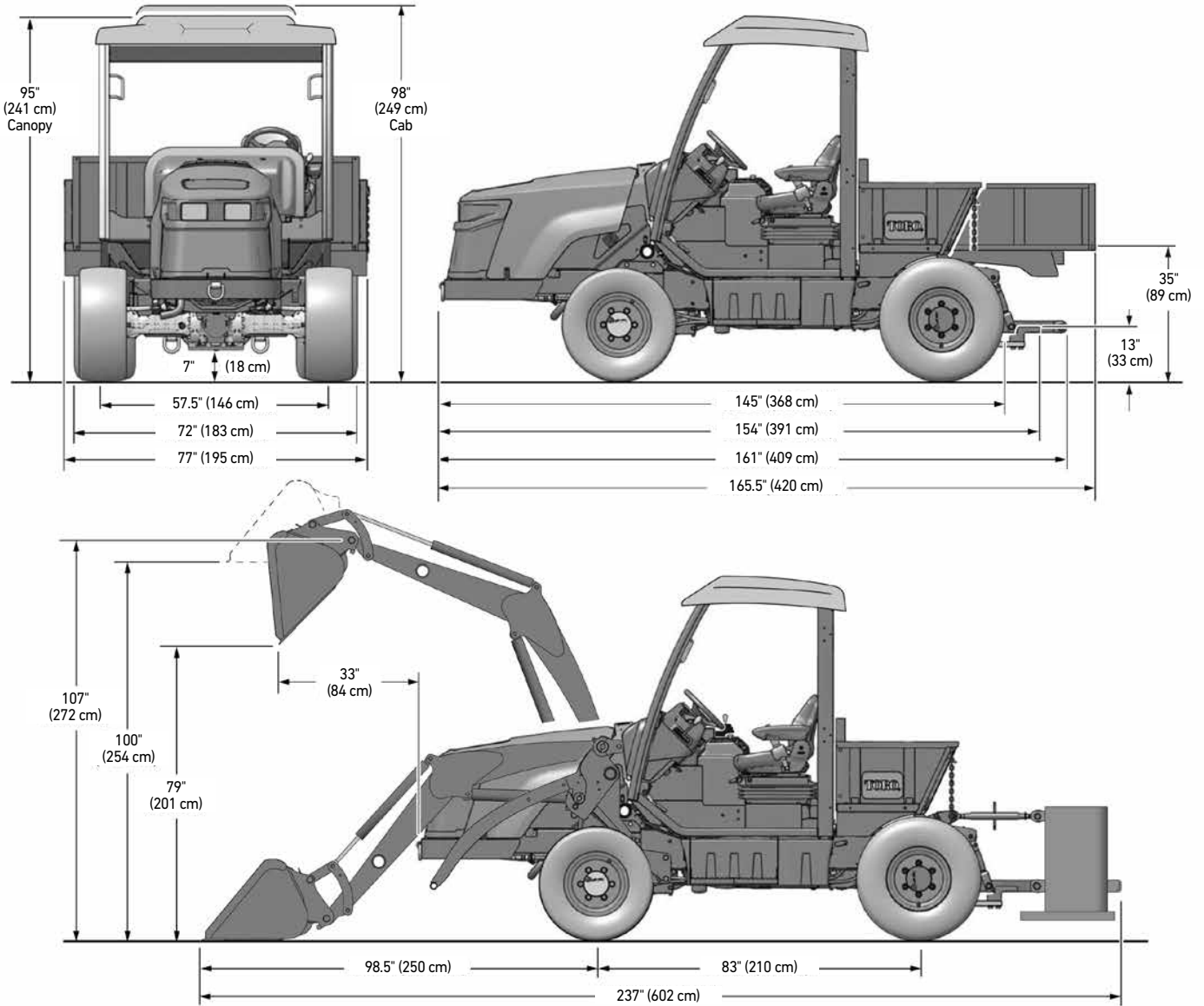

STANDARD BED

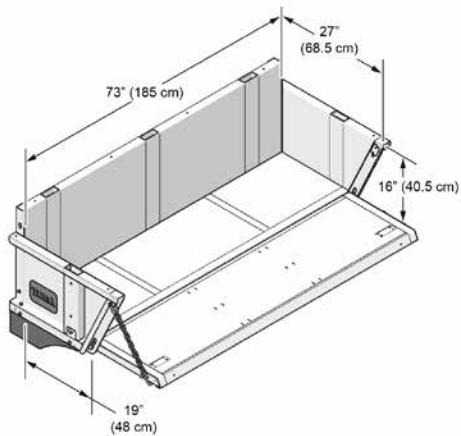

CARGO BED (Optional)

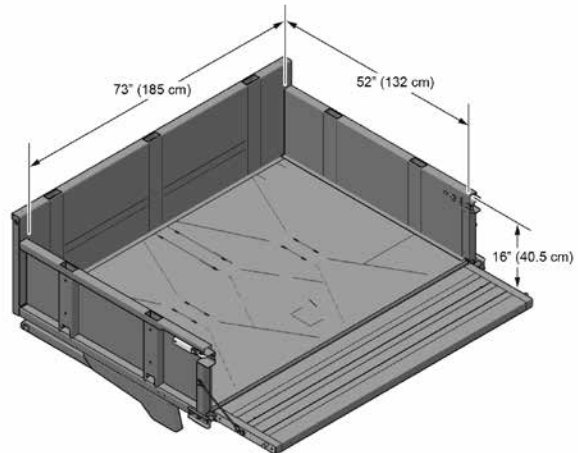

*Specifications and design subject to change without notice. Products depicted in this literature are for demonstration purposes only. Actual products offered for sale may vary in design, required attachments and safety features. Consult your local Toro Distributor. Refer to Operator's Manual for further information and instructions.

