

# Lawn Genie

Dual-Program Electro-Mechanical  
Controller

## Installation and Operation Guide

---

► For Models L70206P/L70209P

---

► Please read instructions completely before  
attempting to install or operate controller.

---

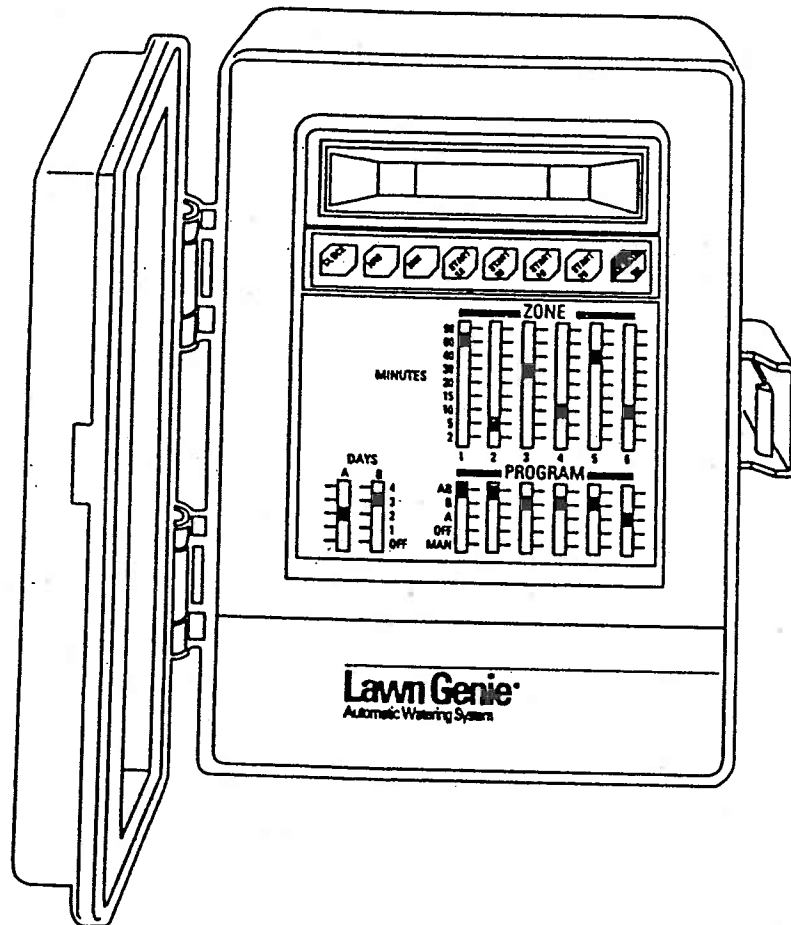

*This manual explains how to install your Lawn Genie sprinkler controller and program it for the watering schedule that's right for your garden. The following sections are arranged to match the most efficient installation sequence. Refer to them in the order presented for best results.*

**Introduction** ..... 3

**Features** ..... 5

**Installation**

  Installing the controller ..... 6

  Connecting the valves ..... 7

  Connecting the transformer and battery ..... 8

**Programming**

  Setting the current time ..... 9

  Selecting the right program ..... 10

  Setting the day schedules ..... 11

  Setting the start times ..... 12

  Setting the run times ..... 13

  Typical program for lawn & garden ..... 15

**Additional information**

  Installing a pump-start relay ..... 16

  Special functions ..... 17

  Trouble-shooting ..... 19

  Watering considerations ..... 20

**Warranty** ..... 21

Your Lawn Genie sprinkler controller is the heart of your automated watering system. It lets you supply different parts of your lawn and garden with precisely the water they require, exactly when they require it. All without any effort on your part once you've programmed your system.

The Lawn Genie L70206P and L70209P controllers give you four ways to control how you distribute water to various parts of your yard. Here's how they work:

**Zone control**

Lawns, shrubs, flower beds and other foliage all need different amounts of water. You can tailor the water delivered to different parts of your yard by assigning a

different run time to one or more sprinkler heads controlled by a single valve. Each valve and the sprinklers it controls are called a Zone. The L70206P lets you divide your yard into as many as six Zones; the L70209P allows as many as nine.

**Programming options**

Certain parts of your yard may need water every day. Other parts may need water only twice a week. Dual programming lets you divide your Zones into two different groups, and assign each group a different interval between watering days. For example, Program A may water Zones 1, 3, 4 and 5 every third day, and Program B may water Zones 2 and 6 daily. It's also

possible to assign a Zone to both A and B Programs at once. For details, see "Selecting the right Program" on page 10.

**Start times**

Each Program lets you specify up to two different times to start watering the Zones it controls. For example, you might have Program A water all its Zones twice a day starting at 6 AM and 4 PM, while Program B waters its Zones at 8 AM and 2 PM.

**Watering run times**

To deliver the correct amount of water to the foliage within each Zone, you can set each Zone to shut off after a specified period of time — from 2 to 99 minutes.

**Here's how the controller connects to your system**

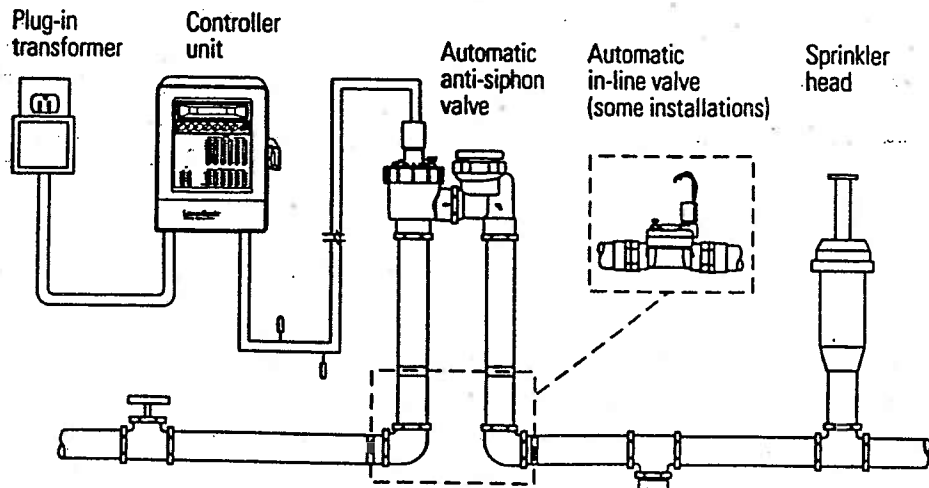

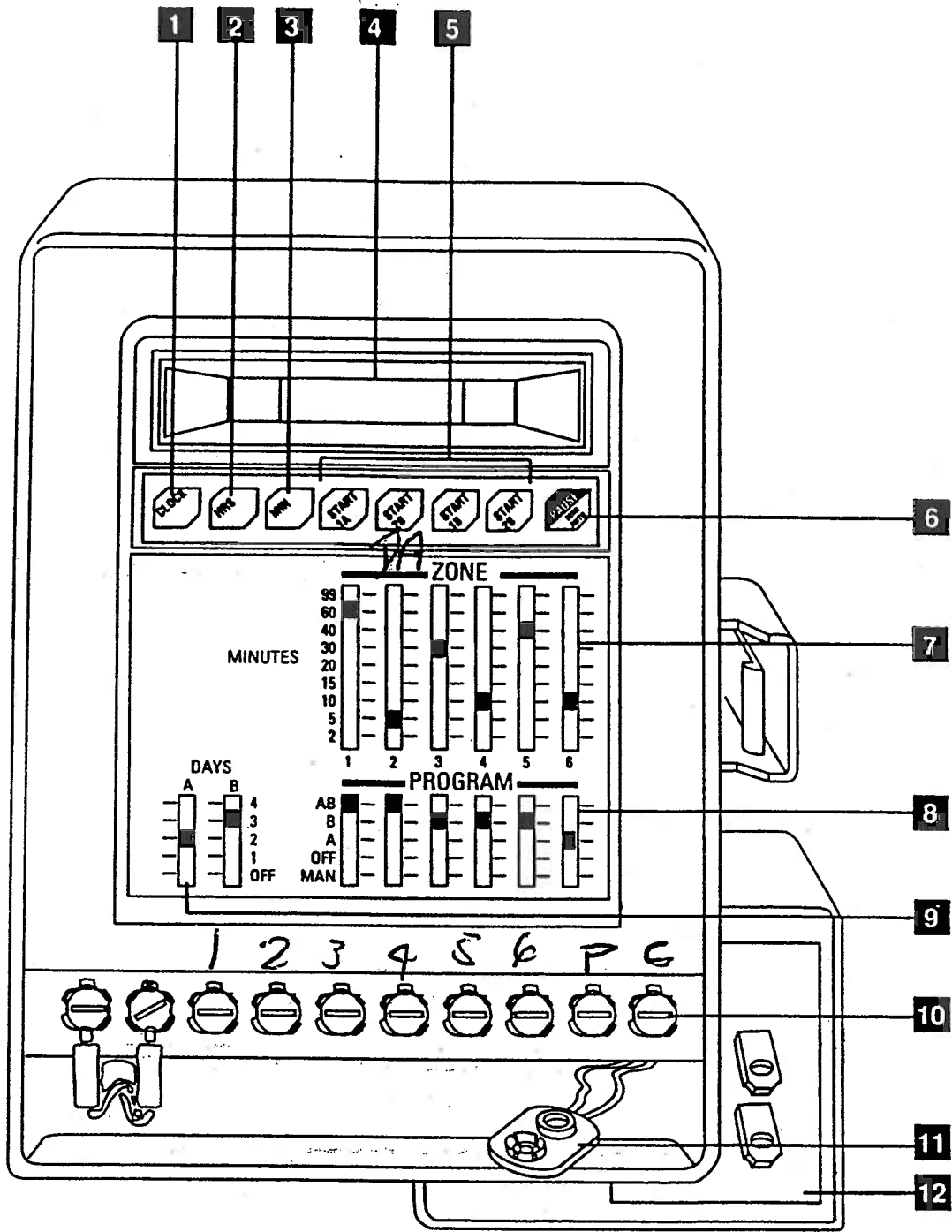

- 1 Clock key**  
For setting time of day.
- 2 Hours key**  
For setting current hour and hours of start times.
- 3 Minutes key**  
For setting current minute and minutes of start times.
- 4 Display**  
Shows current time of day, Zone being watered and watering run time; also indicates programming errors and short circuits.
- 5 Start keys**  
For setting up to four start times per day (2 on Program A and 2 on Program B).
- 6 Pause/Semi-Auto key**  
For temporarily interrupting a watering cycle in progress, or manually starting a watering cycle at other than the programmed time.
- 7 Zone-Minutes switches**  
For setting separate watering run times for each Zone — from 2 to 99 minutes.
- 8 Zone-Program switches**  
For separately assigning each Zone to Program A, B, or both. Also for manually watering a selected Zone or programming to OFF.
- 9 Program-Day switches**  
For assigning each Program a different interval between watering days.
- 10 Terminal screws**  
For connecting valve wires to controller.
- 11 Battery connector**  
For installing 9-volt battery for backup power in case of power failure.
- 12 Plug-in transformer**  
For converting 120-volt household current into safe, low-voltage power. (250-volt source on 50 Hz units.)

## Installing the controller

### Select the location

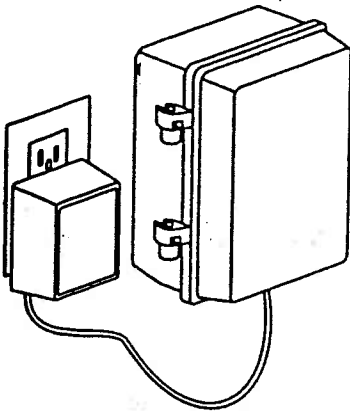

A. Choose an indoor location near a standard 120-volt dual electrical outlet. (250-volt outlet for 50 Hz international units.)



**CAUTION:** DO NOT place the controller where temperatures may exceed 130° Fahrenheit (55° Centigrade), on a circuit controlled by a switch, or on the same circuit as a high power user (refrigerator, air conditioner, garage door opener, etc.). Malfunctions may result.

B. If controller must be mounted a greater distance from the outlet, replace the power cord attached to the transformer with a similar electrical cord (available from hardware and electrical supply stores).

### Mount the controller

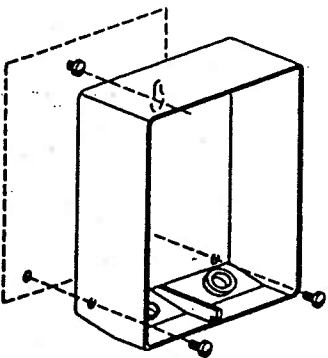

#### L70206P

A. Install a No. 8 screw at eye level in the wall, leaving 1/8" of screw head projecting.

B. Slip the keyhole opening on the back of the controller over the screw head.

C. Open the controller case and install two screws through the holes in the wiring compartment at the bottom of the controller.

#### L70209P

A. Mount the two hangers by attaching each to the upper back of the controller with a screw.

B. Remove the controller's lower panel by removing two screws, then pulling out and down.

C. Position controller at eye level on wall, then fasten using mounting hangers. Secure by installing screw through hole at center bottom of wiring cavity.

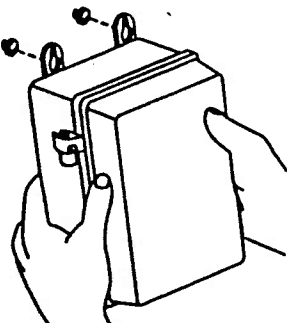

**NOTE:** To install either controller on a plaster or masonry wall, use plastic or lead anchors to secure screws.

## Connecting the valves

### Wire the valves

A. Run valve wiring underground wherever possible.

For line runs less than 800 feet long, use 18-gauge, plastic jacketed thermostat control wire; over 800 feet, use 14-gauge wire. Your dealer can provide this wire in 2, 3, 4, 5, 6, 7 and 8-wire color-coded strands.

B. Connect a single common wire to one of the wires from each valve.

C. Solder or join all splices with wire nuts; then seal with vinyl or waterproof cement to assure a water-resistant connection.

**IMPORTANT:** The power transformer is protected by an electronic circuit breaker. Do not connect a combination of valves requiring an inrush current of more than 1 amp at 24 VAC.

Wires to individual controller terminals

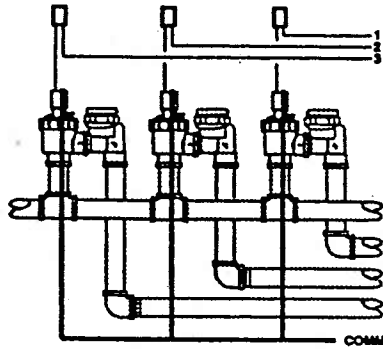

One wire from each valve connects to a single common wire running to controller.

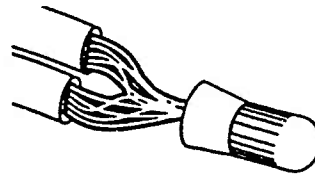

### Connect the valve wires to controller

A. Run all valve wires up through hole in bottom of controller.

B. Connect the wire from valve number 1 to the terminal screw marked 1 on the controller; the wire from valve number 2 to the terminal 2, and so on. This allows your controller to selectively water the Zone controlled by each valve.

 **NOTE:** On the L70206P, terminal designations are marked on the inside of the wiring cover.

C. Connect the common wire to the terminal marked COMM.

D. If using a water pump or master valve, refer to page 16 for installation details.

CONTROLLER

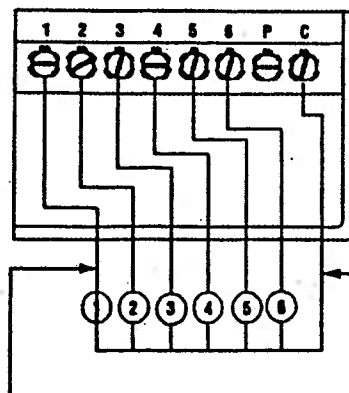

Individual wires connect valves to separate terminals

Single common wire connects all valves to COMM terminal

## Connecting the transformer and battery

### Connect the transformer

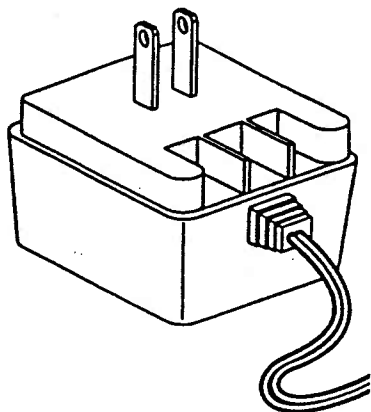

- A. Run the power cable from the transformer up through the smaller of the two openings in the bottom of the controller.
- B. Connect one lead to each terminal screw marked 24V. Make sure terminals at the end of the cable do not touch.
- C. Plug in the transformer.



**CAUTION:** Use with supplied transformer ONLY!

### Connect the battery

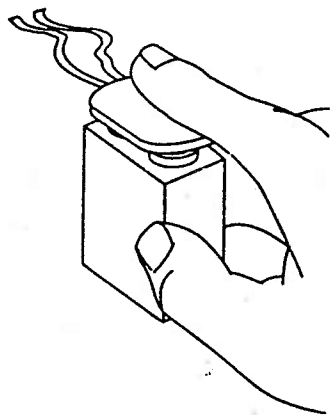

- A battery back-up system is built into your Lawn Genie controller to maintain your programmed watering schedule in memory in case of temporary power failure.
- A. Connect a 9-volt alkaline battery (not supplied) to the battery connector in the wiring compartment of the controller case.
  - B. Place the battery in the wiring compartment.
  - C. Replace the wiring compartment cover.
  - D. Replace the battery at least once a year. More often if frequent power failures occur.



**CAUTION:** Do not allow the battery connector to touch the controller's terminal strip (directly above the wiring compartment). Also, do not connect or disconnect valve wires while any Zones are in operation.



**NOTE:** Check local codes to ensure that wiring and installation meet all requirements.









## Setting the current time

In the controller's display, 12 P represents 12PM, or noon, and 12 A represents 12AM, or midnight. When the power is first turned on, the controller always displays a time of 4:00 P (4:00 PM).



**Set the current time:**

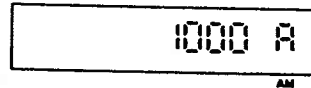

Setting the current time is easy. Here's how you'd do it if the time were now 10:03 AM.

- A. Press 
- B. Press  and hold key down until display shows current hour and A (AM) or P (PM).
- C. Press  and hold key down until display shows current minute. To advance time quickly, hold down  or  until desired time approaches. To advance time slowly, digit by digit, press  or  once for each hour or minute of advance.



 **NOTE:** You must begin setting time within **10 seconds** after pressing . Otherwise, you must press  once again.

## Selecting the right Program

### Divide up your yard

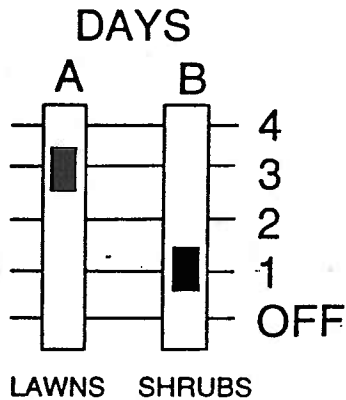

To accommodate the special watering needs of different parts of your yard, you can assign Zones to two separate watering Programs (A and B). Each Program activates the Zones assigned to it as a group with its own specific set of watering days and start times.

Decide how frequently each Zone should be watered. If, for example, Zones covering lawn areas need water every third day, and Zones covering shrubs and ground cover need water every day, you might assign all lawn Zones to Program A and all shrub/ground cover Zones to Program B.

### Program A

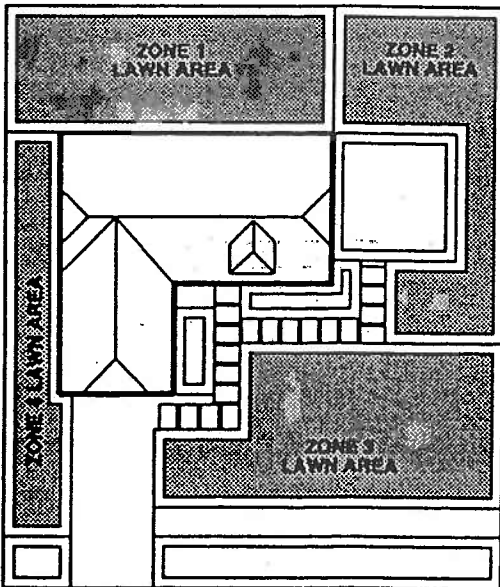

### Program B

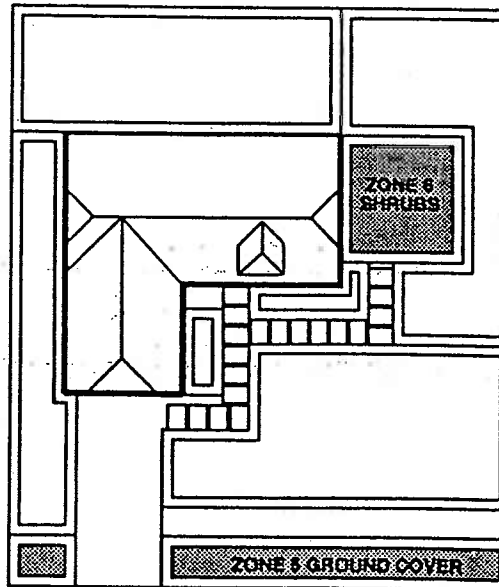

### Assign a Program to each Zone

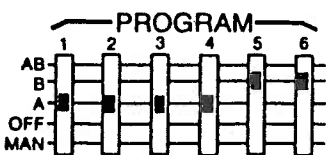

Now simply set the PROGRAM switch under each ZONE to desired A or B Program. Unused ZONES should be programmed in the OFF position. For newly seeded lawns or drip irrigation systems requiring multiple daily waterings, you can select a combination A/B setting for up to four start times per day. For use of the manual MAN setting, see page 17.

## Setting watering day schedules

### Select the interval between watering days for each program:

A. Set the DAYS switch to the desired watering frequencies for Programs A and B. **4** waters every fourth day, **3** every 3rd day, **2** every 2nd day, and **1** every day. Set switch to OFF if Program is not in use.



**NOTE:** The day AFTER you program your watering day schedule, becomes DAY 1 of that schedule. For example, if on Monday you set a watering schedule of every 3rd day, watering will take place on Thursday.

Zones programmed to water under one program will operate sequentially, skipping those Zones programmed to OFF. During watering, the Zone number will appear on the left of the display and its run time on the right. The display starts at one minute and counts up to the total run time before changing to the next Zone to be watered.





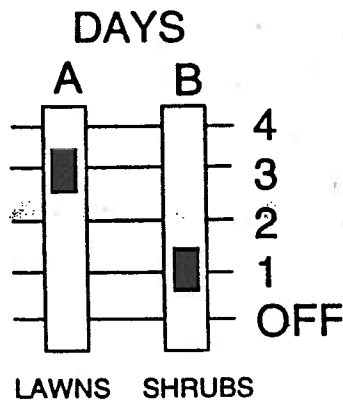

**NOTE:** The L70206P and the L70209P controllers have a preset factory program which will keep your system operating in the event of a power failure and an inactive battery. This preset program will start a watering cycle by day interval as programmed by the DAYS switch, and beginning 10 hours after the time that controller's clock was first supplied with power.



# Setting start times

## Setting the start times

Watering Cycle Start Times						
Start Times	Zone 1	Zone 2	Zone 3	Zone 4	Zone 5	Zone 6
1A 6:00A	•	•	•	•		
2A 9:00A					•	•
1B 8:00P	•	•	•	•		
2B OFF					•	•

Now that you've assigned each Zone to either Program A or B, you're ready to select the times of day that each Program's watering cycle will begin. You can set as many as two start times a day for each Program - watering all Zones under that program up to twice a day. You'll use the four keys under the display: , , and , . Each key will set a time when a watering cycle will start for those Zones set to the corresponding A or B Program.

No Good  
BAD EXAMPLE



**NOTE:** It is not necessary to use all start times available. Chart above is shown as an example of 3-start times only.

Here's how you'd set Program A to start watering at 7:30 PM.

200 A

700 P





730 P

A. Press the  key. (The display will show 200A).

B. Press the  key and hold until display shows the desired hour and **A** (AM) or **P** (PM).

C. Press the  key and hold until display shows the desired minute.



**NOTE:** Once you've pressed a  key, you must press  or  within **10 seconds**. Otherwise you must press  once again before making changes. To simplify programming, write down your watering schedule first, using the reference chart on the back cover of this manual.

D. Repeat procedure for all remaining start times.



**NOTE:** Enter start times in any order. Start times are activated in chronological order, regardless of programming sequence. For example, START 1A may actually be the last watering time of the day.

## Setting run times

E. If any start time is not needed, be sure to set it to the OFF position. Hold the  key down until OFF appears in the display. This occurs just after **1100P**.

OFF

 **NOTE:** Any Zone whose Program switch is in the A/B position will water at every start time programmed (up to 4).

Since all Zones on a Program water in sequence, beginning with the lowest numbered Zone, make sure all Program start times are far enough apart to prevent watering cycles from overlapping. If overlap occurs, the controller will automatically delay the next start time to allow completion of the current watering cycle. A watering cycle that runs past midnight will cancel any overlapping start times before midnight.

## Setting the watering run time—how long to water

Your controller gives you a wide range of run times to provide precisely the right amount of water to each Zone. Settings may vary from 2 to 99 minutes.

To program the watering run time for each Zone, simply move the corresponding MINUTES switch to the appropriate setting (2–99 minutes). Make sure you position switches only **on** the minute marks, and not between them.

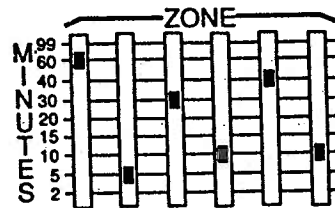

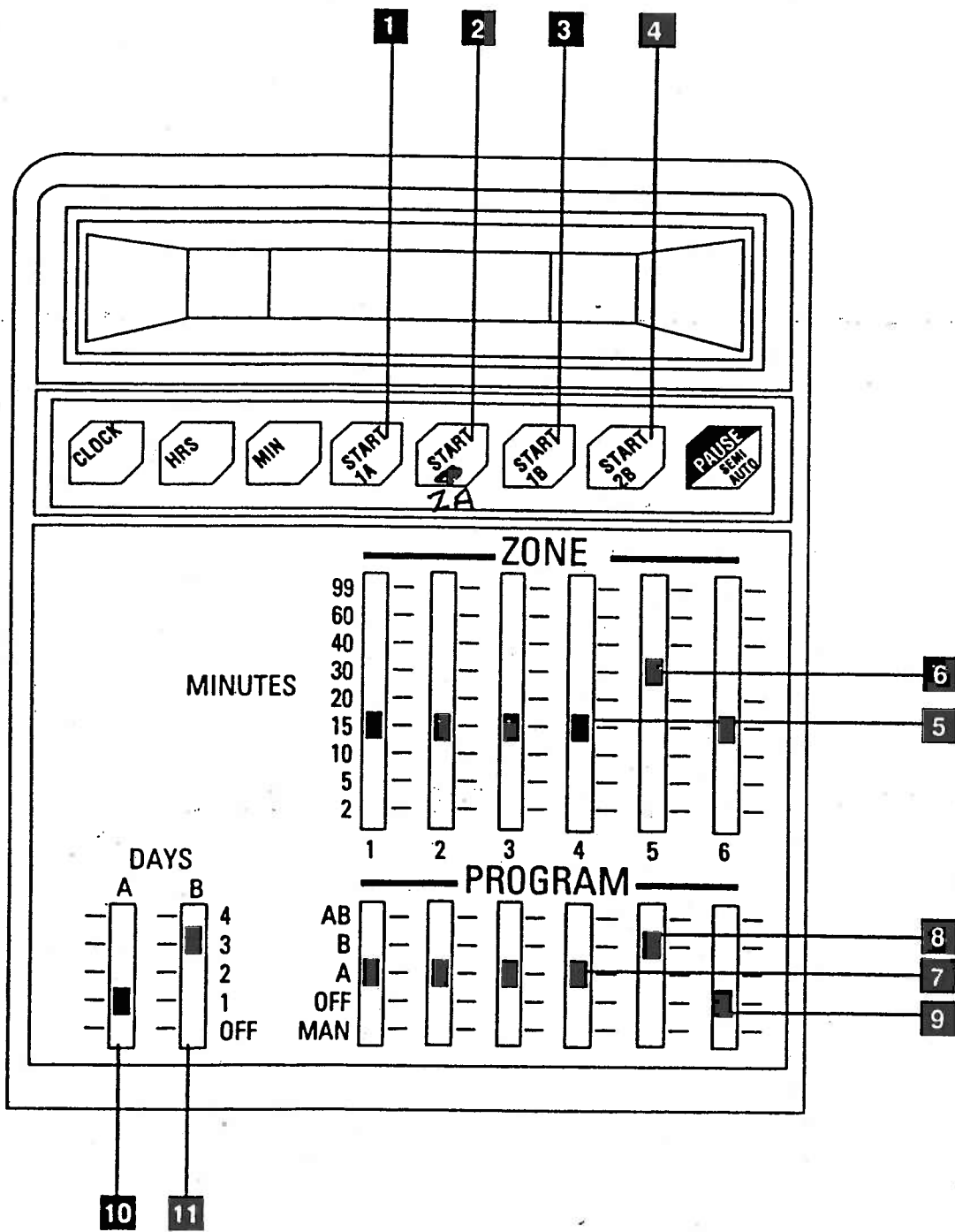

## Typical program for lawn and garden

Here's how you might use your Lawn Genie controller to program a watering schedule for a typical lawn and garden. Please refer to instructions on the preceding pages for details on specific keystroke procedures.

### Set start times (up to two per day) for each Program:

---

- 1** Push to set 6:00 AM start time for Program A. Watering cycle will start at 6:00 AM in Zone 1 and progress sequentially through Zones 2, 3 and 4.
- 2** Push to set second start time for Program A. Watering cycle will start at 2:00 PM in Zone 1 and progress sequentially through Zones 2, 3 and 4.
- 3** Push to set 10:00 AM start time for Program B. Watering will start in Zone 5 only at 10:00 AM.
- 4** Set Start 2B to OFF. Zone 5 will have only **one** watering per day.

### Set run times for each Zone:

- 5** Set Zones 1-4 to water lawn areas for 15 minutes
- 6** Set Zone 5 to water shrubbery for 30 minutes

### Assign Zones to Program A, B, or OFF.

- 7** Assign Zones 1-4 to Program A
- 8** Assign Zone 5 to Program B
- 9** Set Zone 6 to OFF

### Set watering day schedule:

- 10** Set Program A to water every day
- 11** Set Program B to water every third day

## Installing a pump-start relay

To connect your controller to a well pump or master valve:

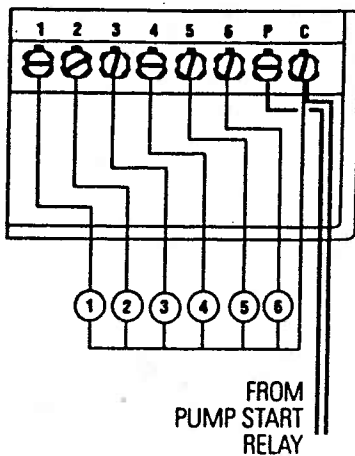

If your water doesn't come from the pipes of a standard public water supply, you may be using an electrically operated master valve, or pump to draw directly from a well, pond, or similar source. In these cases, you'll need to make the following wiring connections so your sprinkler controller can activate the valve or pump.

- Bring two wires up through the same hole in the controller cabinet used for the valve wiring.
- Connect one wire to the terminal marked PUMP.
- Connect the second wire to the terminal marked COMM.
- For master valve installations, connect both wires to a master valve rated at 24 VAC and a current no greater than 9 VA.
- For pump start relay installations, connect the two wires to an auxiliary relay with a coil rated at 24 VAC and a current no greater than 9 VA. Then wire the relay's contact to supply voltage to the pump's contactor. A qualified electrician can make these connections for you. A Lawn Genie L30000W Pump Starter can control a pump up to 2 HP at 240 volts.



**NOTE:** The controller's pump output will turn on whenever a Zone is watering manually or automatically.





## Special functions

### Manual watering

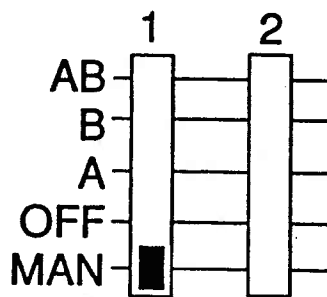

To water a single Zone at a time, move the PROGRAM switch for the Zone you wish to water to MAN. If more than one Zone's Program switch is placed in the MAN position, only the lowest-numbered Zone will water, when that switch is moved off MAN, the next highest-numbered Zone will begin watering.

The MAN setting overrides any automatic or semi-automatic watering cycle, including any cycle in progress.







 **NOTE:** The manual setting will water continuously until the switch is moved. **DO NOT LEAVE SWITCH IN THIS POSITION!**

### Semi-automatic watering

To start a complete watering cycle at times other than those you've programmed, press the  key. All Zones not set to OFF will water. To stop a semi-automatic cycle, press the  key, and within 10 seconds press the  key. Watering will stop, and the display will show OFF for 10 seconds before returning to the clock mode.

### Interrupting the watering cycle

To freeze an automatic or semi-automatic watering cycle at that point in the Zone's run time, press . The display will alternately flash PAUSE and the Zone's number and run time. To resume the watering cycle, press  again, and the Zone's count will continue.

 **NOTE:** If  is activated and forgotten, the controller will automatically reset itself at midnight and begin watering at the first start time of the new day.

## Special functions

### Turning off the system



---

To prevent automatic watering (for example if rain is expected), move the DAY A and DAY B switches to OFF when no cycle is in progress. You may still water manually in this mode.

### Electronic circuit breaker operation

---

If the controller detects a short circuit, it will automatically turn off power to the shorted Zone's automatic valve. The display will alternately flash **FUS** and the shorted Zone's number and run time. The controller will continue to automatically water all other Zones under the programmed watering cycles, while the display continues flashing the Zone number with the short circuit.

To return the controller and display to normal operating mode after repairing the short, press  or any  key.

## Trouble-shooting

***Malfunctions aren't common, but when they occur, they're often due to one of these frequently overlooked causes.***

<b>Problem</b>	<b>Possible Cause</b>
<i>One or more valves do not water</i>	<ol style="list-style-type: none"><li>1. Faulty solenoid</li><li>2. Poor wire connection</li><li>3. Possible break in wire</li><li>4. Valve flow stem screwed down too far</li></ol>
<i>FUS and a Zone number are alternately flashing on display and no watering will occur</i>	<ol style="list-style-type: none"><li>1. Faulty solenoid</li><li>2. Poor or shorted wire connection</li><li>3. Slide switches for one or more unconnected Zones are in MAN position, not OFF.</li></ol>
<i>Clock won't keep correct time</i>	<ol style="list-style-type: none"><li>1. Controller on circuit controlled by a switch</li><li>2. Controller on same circuit as high power user (refrigerator, air conditioner, garage door opener, etc.)</li></ol>
<i>Zones turn on when they're NOT programmed to start</i>	<ol style="list-style-type: none"><li>1. Total combined run times have overlapped with another start time</li></ol>
<i>Clock has correct time and Zones appear to be functioning properly, but no valve will turn on</i>	<ol style="list-style-type: none"><li>1. One or more Zone switches are in the OFF position</li><li>2. The common wire is not connected</li><li>3. Valve flow stem is screwed down too far</li></ol>
<i>One Zone won't shut off electrically</i>	<ol style="list-style-type: none"><li>1. Zone switch is in MAN position</li><li>2. Faulty valve</li><li>3. Particles of dirt or debris are stuck in valve</li><li>4. Accidental programming of multiple start times</li></ol>

***WARNING: Do not link two or more controllers using a common transformer or common wire.***

**For additional assistance call our Customer Service Hot-line (800) 231-5117.**

## 2-Year Limited Warranty

### LIMITED WARRANTY

Lawn Genie warrants to the purchaser of its products for a period of two (2) years from the date of original purchase that any defective product proved to be caused by faulty workmanship or faulty materials, when installed per instructions and used in a normal manner, will be repaired or replaced at Lawn Genie's option at no charge, providing the product is received at the Lawn Genie factory, or authorized factory service center, with all transportation charges prepaid within two years of the date of original purchase. This warranty does not apply to damages or malfunctions resulting from accidents, misuse or neglect. Lawn Genie will not pay labor or other costs of removal or reinstallation of any so-called defective products.

NO IMPLIED WARRANTIES (INCLUDING BUT NOT LIMITED TO) FITNESS FOR A PARTICULAR PURPOSE, WHERE APPLICABLE, AND MERCHANTABILITY SHALL EXTEND BEYOND THE PERIOD OF THE EXPRESS WARRANTY DESCRIBED ABOVE. IN NO EVENT SHALL LAWN GENIE BE RESPONSIBLE FOR INCIDENTAL OR CONSEQUENTIAL DAMAGES TO PROPERTY WHICH MAY ARISE FROM OR RELATE TO THE PURCHASE OF ANY LAWN GENIE PRODUCT.

Some states do not allow limitations on how long an implied warranty lasts or the exclusion or limitation of incidental or consequential damages, so one or both of the above limitations may not apply to you.

This warranty gives you specific legal rights, and you may also have other rights which vary from state to state.

To exercise your warranty, send unit, with photocopy of dated receipt, postage prepaid to\*:

 **Lawn Genie**

27631 La Paz Rd.

Laguna Niguel, CA 92656

800-231-5117