

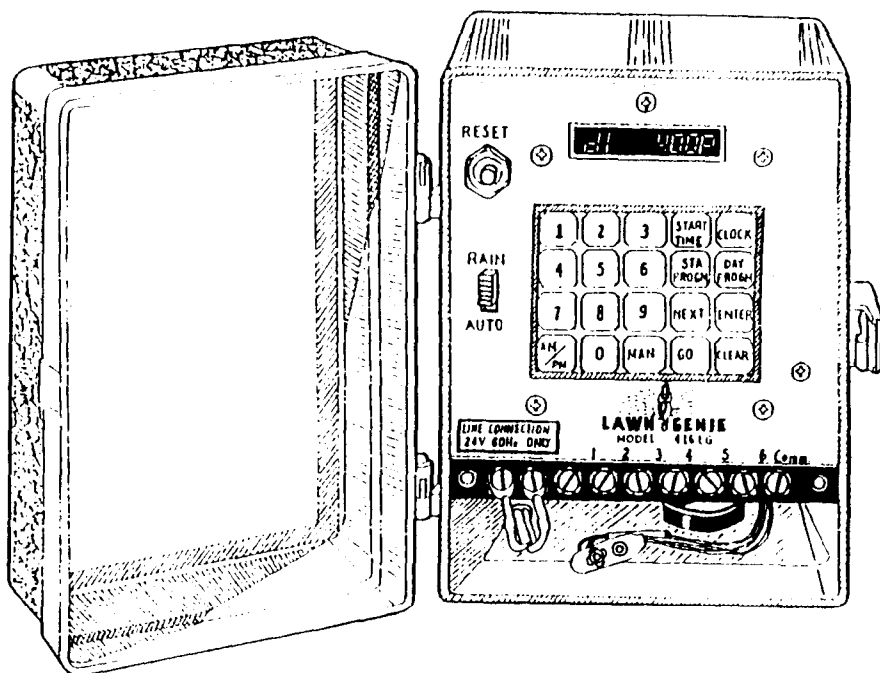

SOLID STATE 6 STATION LAWN SPRINKLER CONTROL

6STATION LAWN SPRINKLER CONTROL



INSTALLATION AND OPERATING GUIDE
MODEL 416LG

DESCRIPTION

The 416LG is a solid slate 6 station lawn sprinkler control featuring a dual program that permits watering lawns and shrubs according to different schedules. Watering may be programmed from every 14 days to as many as three times a day. The watering time can be set from 1 minute to 99 minutes for each circuit.

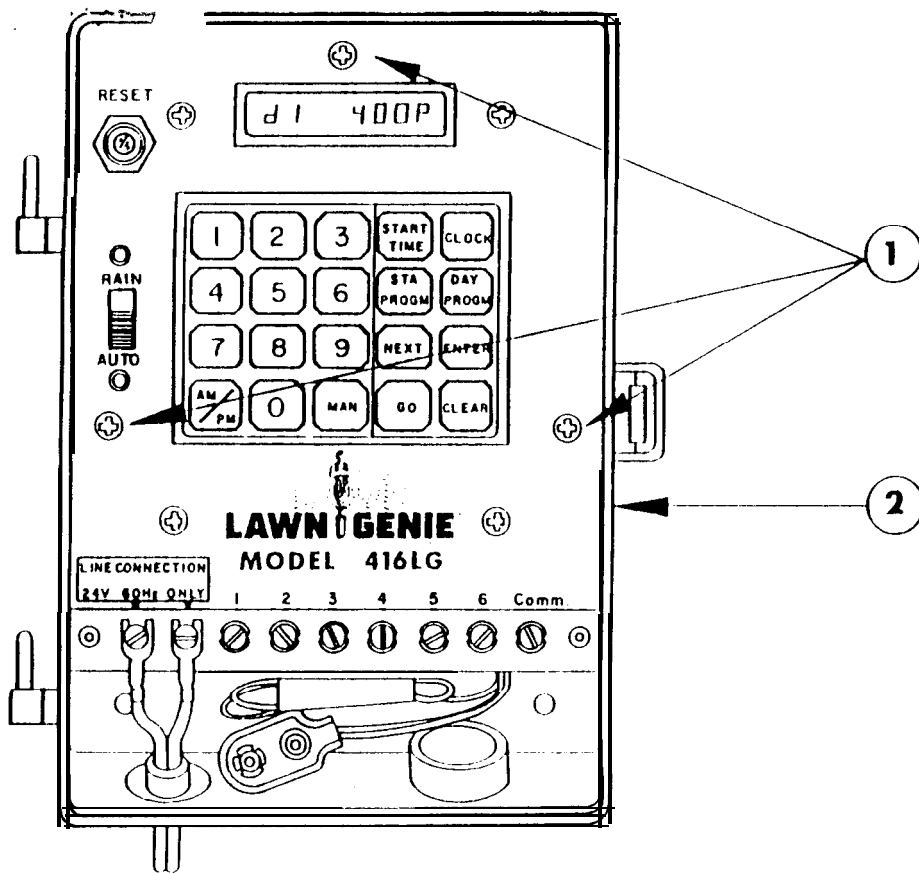

INSTALLATION INSTRUCTIONS

- Step 1. Select location for controller in a protected area near a 110 Volt duplex receptacle. Longer distances (up to several hundred feet) between the controller and the 110 Volt duplex receptacle are permissible by replacing the supplied power cord with similar 18 gauge cord available at hardware and electrical supply houses. **NOTE:** Avoid using a receptacle that is on a switched circuit.
- Step 2. Install one No. 8 screw at eye level at selected location, leaving head of screw extended 1/8". Hang controller on screw by inserting head of screw into keyhole opening on back of control box. **NOTE:** Installing on plaster or masonry walls should be done with plastic or lead shields to secure screws. Open control box, straighten into desired position and install two screws through holes in wiring compartment.
- Step 3. Wiring to the valves can be placed underground alongside the pipes. Run one common wire to each location to serve all the valves at that location. Use 18 gauge solid wire plastic jacketed thermostat control wire for runs not over 800 feet and 18 gauge over 800 feet. Be sure all splices are soldered or joined with wire nuts and sealed with vinyl cement or other suitable water-proofing cement. This wire is available from your dealer in 2,3,4,5,6,7 and 8 color coded wires. **IMPORTANT:** The power transformer is protected by a circuit breaker. Do not connect a valve or combination of valves requiring more than 1 AMP. at 24 VAC.

NOTE: DO NOT CONNECT THE PUMP START LEAD DIRECTLY TO THE COMMON TERMINAL. IF A PUMP STARTER RELAY IS NOT USED LEAVE THE LEAD DISCONNECTED.

CAUTION: PLACE THE RAIN SWITCH IN THE RAIN POSITION BEFORE CONNECTING VALVE WIRES TO THE CONTROL. DO NOT CONNECT OR DISCONNECT VALVE WIRES FROM AN ACTIVE (HOT) CIRCUIT.

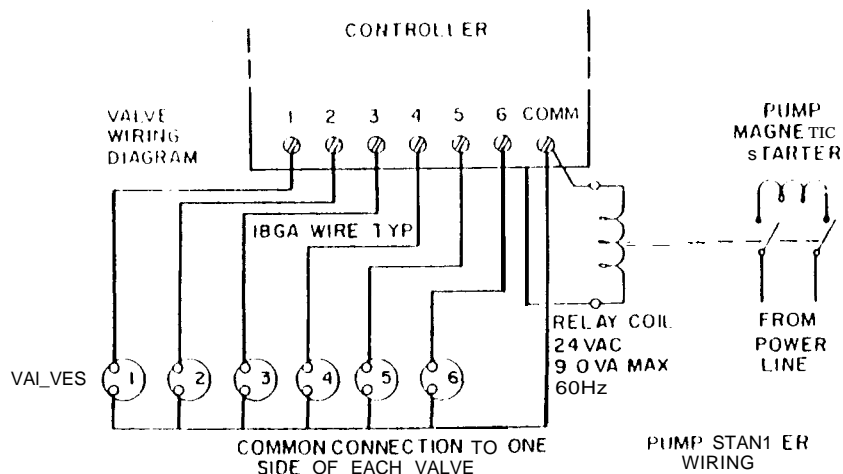

Step 4. Bring valve wires up through insulated bushing at right side of box. Connect the wire from valve #1 to the terminal on control chassis marked 1. connect valve #2 to terminal 2. etc. Connect the common wires to the terminal on chassis marked Comm.

Step 5. Connect power leads to "plug-in" transformer. one lead to each terminal. being certain that terminals on cord are not touching. Remove center screw from cover plate of wall outlet, plug transformer into bottom socket of duplex outlet, replace screw through transformer bracket, thus securing transformer and cover plate in position.

NOTE: It is possible to develop an electrical transient when connecting power to the control. This may cause the time display to read other than d1 400A. To remedy this situation unplug the transformer then reinsert it into the wall receptacle.

Step 6. Connect a 9 volt alkaline transistor battery (not supplied) to the battery connector and place in the wiring compartment. NOTE: Use a Mallory MN1604, Eveready 522 or equivalent battery.

CAUTION: DO NOT ALLOW THE BATTERY CONNECTOR TO CONTACT THE CONTROLLER'S TERMINAL STRIP.

TO REMOVE CONTROL CHASSIS: Remove screws (1) that retain controller chassis (2) in control box.

NOTE: Due to varying regulations, check your local codes.

PROGRAMMING INSTRUCTIONS

The sequence for programming the 416LG solid state control are as follows:

1. Read the programming instructions.
2. Fill out the program card.
3. Program the control.

NOTE: PRESS KEYS WITH FINGERS ONLY

Step 1.

SET DAY AND TIME

SEVEN DAY NUMBER CHART							
DAY	SUN	MON	TUE	WED	THUR	FRI	SAT
NO.	1	2	3	4	5	6	7

DISPLAY EXAMPLE



Upon power-up the display will automatically show a day number (1 means Sunday) and time of 4:00 P.M. You are to set the clock to the present day and time. Change the day number by repeatedly pressing the **[NEXT]** key until the selected day number appears on the display. Set the time by pressing the required numbered keys and **[AM/PM]**, if needed. NOTE: Noon is 12:00 P.M. and midnight is 12:00 A.M.

- A. Press **[CLOCK]** The clock is now stopped and ready to be changed.
- B. Press **[NEXT]** repeatedly, to change the day number.
- C. Press **[1][0][0]** three or four numbered keys for time of day.
- D. Press **[AM/PM]** to change the displayed A or P.
- E. Press **[GO]** The clock starts.

NOTE: If you press a wrong key press **[CLEAR]** then set the time again. If you may have set an invalid time, such as 1300, upon pressing **[GO]** the display will go blank except for an "E," indicating an error. Press **[CLEAR]** and repeat Steps C and E above.

Step 2:

PROGRAM WATERING CYCLE START TIMES

DISPLAY EXAMPLE

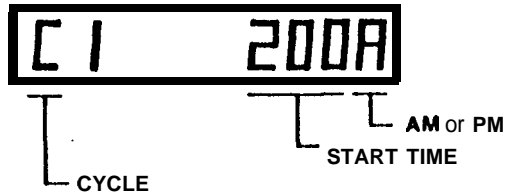

Upon power-up cycle No. 1 will preset with a time of 2:00 A.M. You can enter into memory up to three start times using the **NEXT** key to change cycle numbers and numbered keys to program the start times. Start times programmed will repeat once every 24 hours. At each cycle start time Stations 1 through 6, programmed to water in Step 3, will water sequentially. NOTE: There must be a minimum of one minute between the end of the last station's watering and the next start time. If an overlap does occur the next start time will be bypassed.

EXAMPLE: Cycle start time C1: 200A
 Watering time 10 minutes/station
 For 6 stations : 60 minutes.
 Next possible Cycle start time C2: 301A

- Press **START TIME** Cycle No. 1 is now displayed
- Press **1:00:00** three or four numbered keys for time of day.
- Press **AM/PM** to change the displayed A or P.
- Press **ENTER**. Cycle No. 1 is now entered into memory.
- Press **NEXT** to display Cycle No. 2.
- Repeat Steps B, C and D for the second start time.
- Press **NEXT** to display Cycle No. 3.
- Repeat Steps B, C and D for the third start time.
- Press **GO** to return the display back to the clock.

IF ONLY ONE START TIME IS DESIRED. PERFORM STEPS A, B, C, D AND I ONLY.

NOTE: If you press a wrong key press **CLEAR** then re-enter the correct time. If you should program an invalid time, such as 13:00, upon pressing **ENTER** the display will go blank except for an "E", indicating an error. Press **CLEAR** and repeat Steps B and D.

Step 3:

PROGRAM STATION PROGRAM NUMBERS AND WATERING RUN TIME

STATION KEY NO.	WATERING PROGRAM	PROGRAM CHART
0		NO WATERING
1		PROGRAM 1 (Lawn)
2		PROGRAM 2 (Shrubs)

DISPLAV EXAMPLE

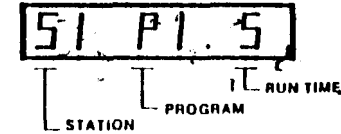

The Dual Program capability of the control can be achieved as follows: Divide the valve stations to satisfy your watering needs. **Example:** Stations 1 through 4 Program 1 (lawn), and Stations 5 and 6 Program 2 (shrubs). These groups of stations may be watered independently of each other or together by using an appropriate program number in Step 4.

Upon power-up all six stations will be preset with Program 1 and a 5 minute watering run time. You are to enter a program number and a watering run time for each station. The first numbered key pressed will be the program number **while the next one or two numbered keys pressed will be the run time** in minutes. (1 to 99 minutes.) NOTE: No matter what the watering run time a "0" program number will prevent watering. A "0" only, can not be entered for a **watering run time**.

- Press **STA PROG** Station No. 1 is now displayed.
- Press **1** one numbered key for the selected program number
- Press **1:00** one or two numbered keys for the desired **watering run time** for Station No. 1.
- Press **ENTER** Station No. 1 is now entered into memory.
- Press **NEXT** Station No. 2 is now displayed
- Repeat Steps B, C and D for Station No. 2
- Press **NEXT** for Station No. 3
- Repeat Steps B, C, D and E for a total of six stations.
- Press **GO** to return the display back to the clock.

NOTE: If you press a wrong key press **CLEAR** then re-enter the correct program number and watering run time. If you should program an invalid program number, such as 3, upon pressing **ENTER** the display will go blank except for an "E" indicating an error. Press clear and repeat Steps B, C and D.

Step 4:

PROGRAM DAY WATERING PROGRAM NUMBERS

DAY WATERING PROGRAM CHART	
KEY NO.	PROGRAM
0	NO WATERING
1	PROGRAM 1 (Lawn)
2	PROGRAM 2 (Shrub,)
3	PROGRAM 1 AND 2 (Both)

FOURTEEN DAY NUMBER CHART							
DAY	SUN	MON	TUE	WED	THUR	FRI	SAT
1st Wk	1	2	3	4	5	6	7
2nd Wk	8	9	10	11	12	13	14

DISPLAY EXAMPLE

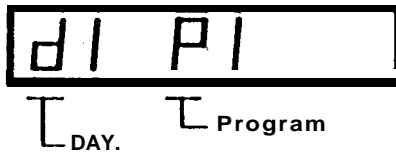

Upon power-up all fourteen days will be preset with Program 1 (Lawn). You are to enter a program number, which corresponds to the group of stations you wish to water on that day, for each of the fourteen days by pressing a numbered key.

- A. Press **DAY PROGM**. Day No. 1 is now displayed.
- B. Press one numbered key for the selected program number.
- C. Press **ENTER**. Day No. 1 is now entered into memory.
- D. Press **NEXT**. Day No. 2 is now displayed.
- E. Repeat Steps B and C for Day No. 2.
- F. Press **NEXT**. Day No. 3 is now displayed.
- G. Repeat Steps B, C and D for a total of fourteen days.
- H. Press **GO** to return the display back to the clock.

NOTE: If you press a wrong key press **CLEAR** then re-enter the correct program number. If you should program an invalid program number, such as 4. upon pressing **ENTER** the display will go blank except for an "E" indicating an error Press **CLEAR** and repeat Steps B and C above.

ANY PROGRAM CAN BE REVIEWED AS FOLLOWS:

Press **START TIME**, **STA PROGM** or **DAY PROGM**.

Press **NEXT** repeatedly to display programs.

Press **GO** to return to the clock

USE OF THE PROGRAM CARD:

The **program card** can be an aid to programming and a record for future use. This could be useful in the event of a power outage and a battery failure. The controller would power-up with a preset program and your program card would be your only record of your programming. The program card **has boxes which are to be filled in with** the numbers you want programmed. Read the programming instructions before marking the card.

1. When you enter the card data into the controller's memory mark the card with the day number and time.
2. Determine the start times you wish in a day and mark the card with these times.
3. Determine what program number you want for each of the six stations and mark the card. Mark a "0" for any station not to water or any station without valve wires.
4. Determine the watering run time for each of the six stations and mark the card.
5. Determine the day program number for each of fourteen days and mark the card.

Following the program instructions enter the above data into the controller's memory.

OPERATING INSTRUCTIONS:

1. **DISPLAY:** The day number and time of day will be displayed except when a watering cycle is in progress or while programming. When on battery operation the display will be blank.
2. **KEY BOARD:** Use to program the controller's memory, recall for viewing data stored in the memory, and to start a manual operation.

NOTE: PRESS KEYS WITH FINGERS ONLY.

3. **RAIN SWITCH:** For programmed watering, move switch to the auto position. For shutdown of system (rain) move switch to the rain position.

CAUTION: If a watering cycle is indicated in progress press the **[CLEAR]** key before moving the rain switch, otherwise the memory may be lost.

4. **CIRCUIT BREAKER:** A tripped circuit breaker indicates an electrical problem in the wiring to the valves or in the valve. To reset the circuit breaker, push the reset button.

NOTE: An Electronic Short Protection circuit prevents an external short circuit from damaging the solid state components. If, during a watering cycle, a station detects a short circuit the control will immediately go into a clear mode and return the display to the clock. The circuit breaker may or may not trip.

5. **BATTERY,-MEMORY BACK-UP:** In the event of a power outage the battery will maintain the programmed memory and a reasonably accurate time of day for a continuous period of 48 to 72 hours. If there are only brief power outages the battery should last for a year and should be replaced annually. Replace only with a 9 volt alkaline battery, such as Mallory MN1604 or Eveready 522.

NOTE: Without battery back-up (no battery or dead battery) the control will revert to the preset conditions mentioned in Steps 1 through 4 upon power-up. The control will function as follows: ten hours, after return of power, Stations 1 through 6 will water sequentially for 5 minutes per station. The control will repeat this cycle once every 24 hours thereafter until reprogrammed.

MANUAL OPERATION:

MANUAL MODE 1: All stations programmed to water on the displayed day will water consecutively. Press **[MAN]** then **[GO]**.

MANUAL MODE 2: One selected station will water for its programmed watering run time. Press **[MAN]**, **[NEXT]** repeatedly, until the selected station number appears on the display, then **[GO]**.

MANUAL MODE 3: One selected station will water for an extended watering run time. (maximum of 99 minutes.) Press **[MAN]**, **[NEXT]**, repeatedly, to select the station number, **[] []** one or two numbered keys for the new manual watering run time, then **[GO]** (The automatic run time will not be changed by this operation.)

NOTE: A Station with a "0" program number can not be manually watered.

Use the **[CLEAR]** key to stop any mode of watering before its time to stop. The display will return to the clock.

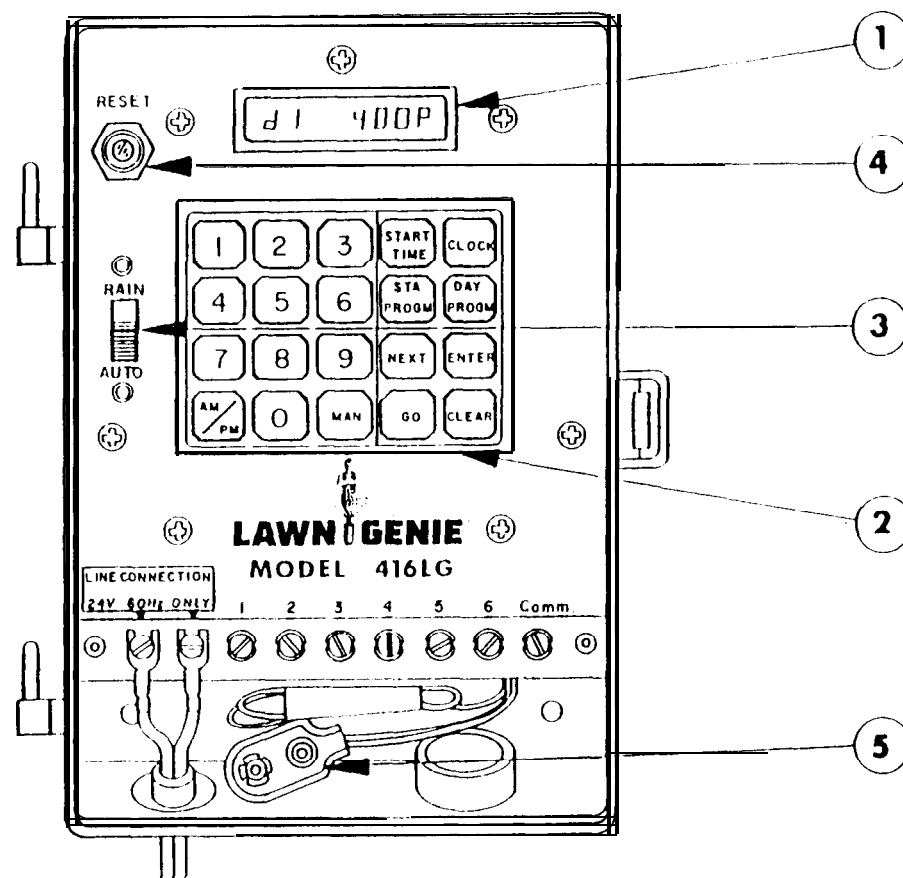

LIMITED WARRANTY

Richdel warrants to the purchaser of its products for a period of one (1) year from the date of original purchase that any defective product proved to be caused by faulty workmanship or faulty material, when installed per instructions and used in a normal manner, will be repaired or replaced at Richdel's option at no charge, providing the product is received at the Richdel factory, or authorized service center, with all transportation charges prepaid within one year of the date of original purchase. This warranty does not apply to damages or malfunctions resulting from accidents, misuse or neglect. Richdel will not pay labor or other costs of removal or reinstallation of any so-called defective products.

NO IMPLIED WARRANTIES (INCLUDING BUT NOT LIMITED TO FITNESS FOR A PARTICULAR PURPOSE, WHERE APPLICABLE, AND MERCHANTABILITY) SHALL EXTEND BEYOND THE PERIOD OF THE EXPRESS WARRANTY DESCRIBED ABOVE. IN NO EVENT SHALL RICHDEL BE RESPONSIBLE FOR INCIDENTAL OR CONSEQUENTIAL DAMAGES TO PROPERTY WHICH MAY ARISE FROM OR RELATE TO THE PURCHASE OF ANY RICHDEL PRODUCT.

Some states do not allow limitations on how long an implied warranty lasts or the exclusion or limitation of incidental or consequential damages, so one or both of the above limitations may not apply to you.

This warranty gives you specific legal rights, and you may have other rights which vary from state to state.

To exercise your warranty, send unit, with photocopy of dated receipt, postage prepaid to:



For further information call TOLL FREE: (800) 231-5117