

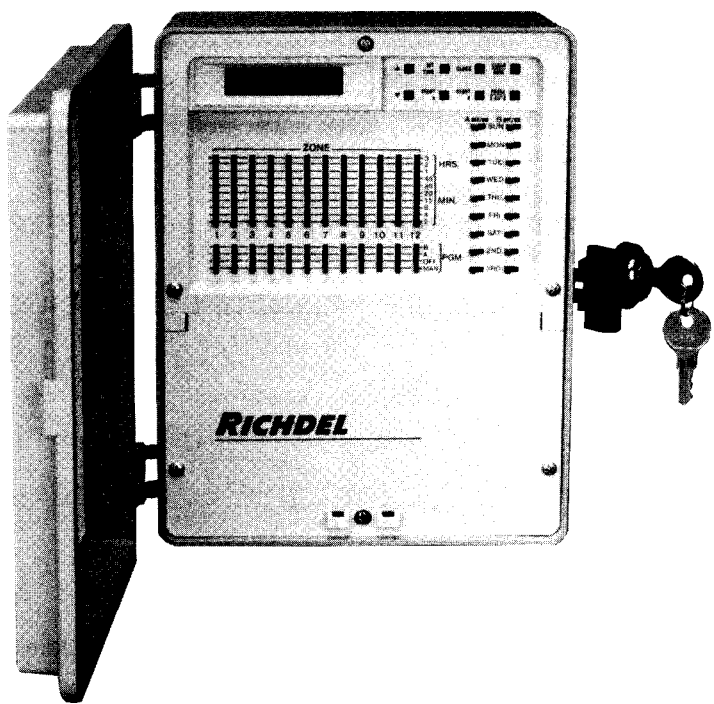

500 SERIES HYBRID IRRIGATION CONTROLLER



INSTALLATION AND OPERATING GUIDE
FOR ALL 508 and 512 MODELS

FEATURES

- * **ZONE CONTROL:** Turns sprinkler valves on and off automatically in sequence.
- * **DUAL PROGRAMMING:** Allows you to water your lawn and landscape on separate schedules.
- * **SELF-PROMPTING DISPLAY:** Makes it easy to set and review watering schedules – guides you every step of the way.
- * **EASY AT-A-GLANCE SETTINGS:** Makes it simple to set watering lengths and days.
- * **MULTIPLE START TIMES:** Lets you water up to four times per day – ideal for new lawns.
- * **EXTENDED WATERING PERIODS:** Allows you to water up to 3 hours a day per zone – ideal for drip irrigation.
- * **PAUSE:** Makes it easy to interrupt watering cycles for yard activities.
- * **MANUAL OPERATING MODE:** Lets you water manually when an automatic watering cycle is not in progress.
- ▣ **ELECTRONIC CIRCUIT BREAKER:** Prevents controller shutdown in case of short circuit in a valve; diagnostic feature displays malfunctioning valve number for easy repair.
- * **PUMP START:** Automatically turns water pump or master valve on and off. (Requires a pump start relay, Model SR-1)

TO USE YOUR NEW CONTROLLER MOST EFFECTIVELY, PLEASE READ THIS MANUAL CAREFULLY BEFORE USE AND REFER TO THE MANUAL IF ANY DIFFICULTIES ARISE.

NOTE: For areas which are vulnerable to lightning strikes, or transient electrical surges caused by unstable power supply, consult your local supplier or contractor for additional protection devices which may be required. (SA120 for 60HZ or SA250 for 50HZ).

CONTENTS

ILLUSTRATION OF THE CONTROLLER PARTS	PAGE 4
INSTALLING YOUR NEW CONTROLLER	PAGE 6
STEP 1: SELECT THE LOCATION	
STEP 2: MOUNT THE CONTROLLER	
STEP 3: WIRE THE VALVES	
STEP 4: CONNECT THE VALVE WIRES TO THE CONTROLLER	
STEP 5: CONNECT THE TRANSFORMER	
STEP 6: CONNECT THE BATTERY	
PROGRAMMING THE CONTROLLER..	PAGE 8
STEP 1: SET THE CLOCK TO CURRENT TIME AND DAY	
STEP 2: SELECT THE RIGHT PROGRAM	
STEP 3: SET THE TIMES OF DAY YOU WANT TO WATER	
STEP 4: SET HOW LONG YOU WANT TO WATER EACH ZONE	
STEP 5: SET THE DAYS YOU WANT TO WATER	
SAMPLE PROGRAM	
CONNECTING THE PUMP START RELAY OR THE MASTER VALVE	PAGE 11
SPECIAL FUNCTIONS	PAGE 12
MANUAL WATERING	
SEMI-AUTOMATIC WATERING	
INTERRUPTING THE WATERING CYCLE	
TURNING OFF THE SYSTEM	
ELECTRONIC CIRCUIT BREAKER	
VOLTAGE SPECIFICATIONS	PAGE 13
TROUBLE-SHOOTING GUIDE	PAGE 14
ZONE LEGEND	PAGE 15

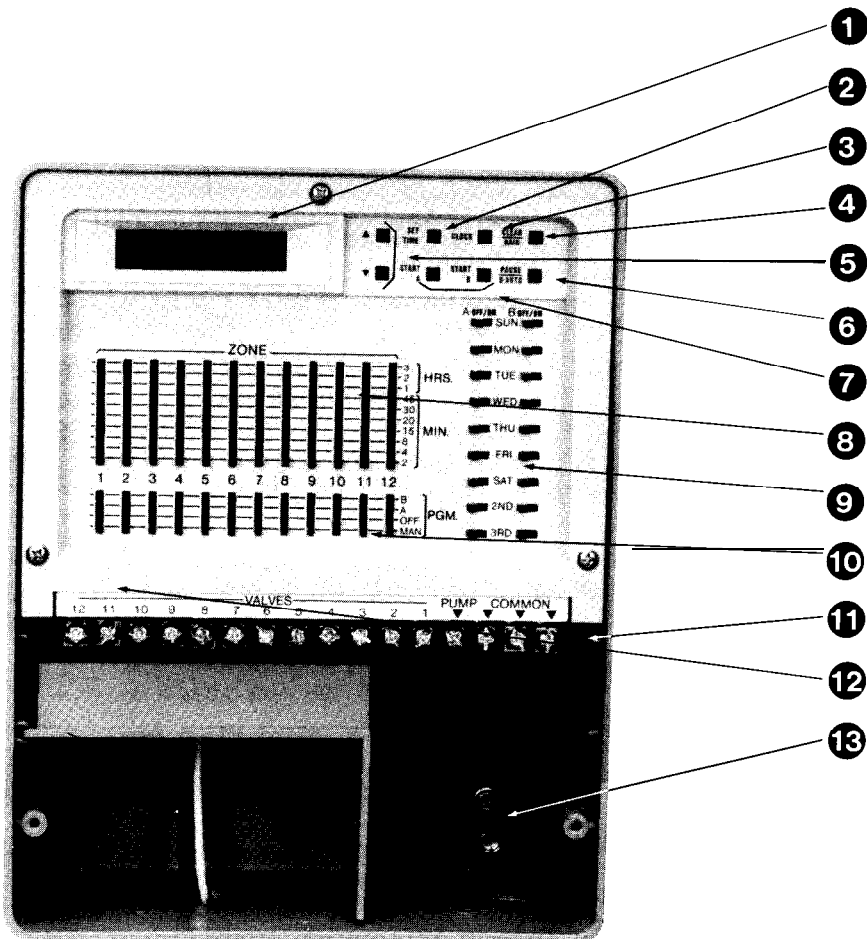

- 1** CONTROLLER DISPLAY
Shows time of day, day of week, zone being watered, watering run time. Also indicates programming errors and short circuits.
- 2** SET TIME KEY
Allows clock and start times to be set with ▲ and ▼ keys.
- 3** CLOCK KEY
Allows you to set the time of day.
- 4** CLEAR/RAIN KEY
Terminates automatic watering in progress or allows you to prevent automatic watering from starting.
- 5** ▲, ▼ KEYS
Increase or decrease time. Used in conjunction with the clock key and start time key.
- 6** PAUSE/SEMI-AUTO KEY
Temporarily interrupts a watering cycle in progress or allows you to start a semi-automatic watering cycle.
- 7** START KEYS
Enable you to set up to four start times per day per program. (4 on program A and 4 on program B).
- 8** ZONE-MINUTES/HOURS SWITCHES
Allow you to choose a separate watering time for each zone – from 2 minutes to 3 hours.
- 9** PROGRAM-DAY SWITCHES
Let you set up different day intervals for each program.
- 10** ZONE-PROGRAM SWITCHES
Let you set a different program for each zone. (A or B).
- 11** TERMINAL SCREWS
Connect transformer, valve wires, and pump relay to the controller.
- 12** INTERNAL TRANSFORMER
Enables controller to connect to a 120 volt source. (250 volts on 50HZ units).
- 13** BATTERY CONNECTOR
Connects to a 9 volt battery for emergency program back-up.

INSTALLING YOUR NEW CONTROLLER

Install your new controller by following these six steps:

STEP 1: SELECT THE LOCATION

- A. Select a protected location near a 120 volt power source.

CAUTION: The controller should not be placed where it is exposed to a temperature exceeding 55° Centigrade (130° Fahrenheit), on a circuit controlled by a switch, or on the same circuit as a high power user; (refrigerator, air conditioner, etc.). Malfunctions may result.

STEP 2: MOUNT THE CONTROLLER

- A. Mount the hanger kit (2 hangers and 2 screws) to the top/back of the controller.
- B. Remove the screws from the lower panel. Pull it out and then down to remove.
- C. Mount the controller on a wall or other solid area to approximate eye level using the mounting hangers. To secure the controller, use the screw hole located at the center bottom of the wiring cavity.

STEP 3: WIRE THE VALVES

- A. Use water tight connectors at all valve connections.

IMPORTANT: The power transformer is protected by an electronic circuit breaker. Do not connect a combination of valves requiring an inrush current of more than 1 AMP at 24 VAC. (Two valves maximum).

STEP 4: CONNECT THE VALVE WIRES TO THE CONTROLLER

- A. Bring valve wires up through the 1 1/4" conduit hole on the bottom of the controller.
- B. Connect the wire from valve number 1 to the terminal screw on the controller marked "1", valve number 2 to terminal marked "2", and so forth.
- C. Connect the common wire to any of the three terminals marked "COMMON".
- D. If using a water pump or master valve, refer to page 11 for instructions and diagrams.
- E. Do not use wire larger than 14GA U.F. when connecting to the terminal strip.

STEP 5: CONNECT THE TRANSFORMER - OUTDOOR MODELS

- A. Run the 120VAC power wire into the wiring cavity using the 7/8" conduit hole in the bottom of the controller. Connect the white wire as the common, the black wire as the power wire, and the green wire as earth ground with standard wire nuts.

STEP 6: CONNECT THE TRANSFORMER - INDOOR MODELS

- A. Connect the power leads from the timer to the plug-in transformer.
- B. Attach one lead to each terminal screw on transformer. Be sure terminals on cord do not touch.
- C. Plug in transformer.

CAUTION: Use with supplied transformer ONLY!

STEP 7: CONNECT THE BATTERY

- Battery will keep program in memory during temporary power failures.
- A. Connect a 9 volt alkaline battery-(not supplied) to the battery connector in the wiring compartment of the controller.
- B. Place battery in the wiring compartment.
- C. Reinstall the cover Panel and replace the screws.
- D. Replace battery at least once a year. More often if frequent power failures occur.

CAUTION: DO NOT ALLOW THE BATTERY CONNECTOR TO TOUCH THE CONTROLLER'S TERMINAL STRIP (DIRECTLY ABOVE THE WIRING COMPARTMENT). ALSO, DO NOT CONNECT OR DISCONNECT VALVE WIRES WHILE ZONES ARE IN OPERATION.

NOTE: Check local codes to be sure wiring and installation will meet all requirements.

250 VOLT INSTALLATIONS

FOR 50HZ INTERNATIONAL UNITS ONLY

STEP 1: SELECT THE LOCATION

- A. Select a protected location near a 250 volt power source.

STEP 5: CONNECT THE TRANSFORMER

- A. Run the 250VAC power wires into the wiring cavity using the 7/8" conduit hole in the bottom of the controller. Connect the white wire as the common, the black wire as the power wire, and the green wire as the earth ground with standard wire nuts.

FOLLOW ALL OTHER INSTRUCTIONS AS DIRECTED.

PROGRAMMING YOUR NEW CONTROLLER

Before programming, read all instructions thoroughly.

STEP 1: SET CLOCK TO CURRENT TIME AND DAY

The controller's clock features a 12-hour format – 12 PM represents noon; 12 AM represents midnight. The AM or PM setting changes at 12:00 so that 1159 AM progresses to 12:00 PM.



When the power is first turned on, the controller automatically displays "SUN" and a time of "4:00 PM". To change the time and day, follow these steps:

A. To **set the** correct hour:

Press the key, then the key. The hour digit and PM will flash. Press the or key until the appropriate hour (AM or PM) is in the display.

B. To **set the** correct minute:

Press the key again. The minute digits will flash. Press the or key until the appropriate minute is in the display.

C. To set the correct day of the week:

Press the key again. The current day of the week will begin to flash ("SUN" is the default). Press the or key until the appropriate day of the week is in the display.

Press the key.

Once you have pressed a function key (,), you have 15 seconds to make a controller entry or the display will automatically return to the original setting.

STEP 2: SELECT THE RIGHT PROGRAM

The controller has several options that allow SIMPLE, FLEXIBLE programming never before offered. The newest of these is the dual program option which provides the ability to water individual areas of any yard separately. These programs are displayed on the face of the controller by the letters "A" and "B".

A simple example of how these programs might be used would be to use program "A" to water all the grass areas of the yard and use program "B" to water all the shrub or ground cover areas of the yard.

NOTE: Any of the zones can be set to water in any combination within the "A" or "B" programs.

Move the "PROGRAM" switch under each zone to the desired watering day program – "PROGRAM A", "B", "OFF", or "MAN" (for manual watering).

STEP 3: SET THE TIMES OF DAY YOU WANT TO WATER

Now that the program selections have been made, the times that each program should start need to be set. This is done by using the "START" keys located to the right of the display. Note that there are 2 keys to choose from: , and . There are 4 start times for each program (A and B).

The key marked with the letter "A" will start all the zones where the program switch is located on the letter "A" and the same is true for the zones where the switch is located on "B". To program the start times for "A" zones, follow these steps:

A. To **set the first start time for "A" zones:**

Press the key. The left side of the display will show a "1" then "A" flashing repeatedly and "2:00 AM" will show at the right.



Press the key. The digit "2" and "AM" will begin to flash.

Press the or key until the appropriate hour is displayed. (Be sure the AM or PM is correct).

Press the key again. The minute digits "00" will begin to flash.

Press the or key until the appropriate minutes are displayed.

B. To **set a second start time for "A" zones:**

Press the key again.

Repeat the previous procedure for all other start times.

Press the key.

C. To **set the start times for "B" zones:**

Press the key.

Repeat the previous procedure used for programming the start times in "A" zones.

If any of the 4 start times are not needed be sure to set them to the "OFF" position. This is done by holding the or key until the word "OFF" is shown in the display, this occurs just after "1100 PM".

Once you have pressed a key, you must press the key within 15 seconds. Otherwise, you must press the key again to make the changes.

CONNECT PUMP START RELAY OR MASTER VALVE



Leave enough time between start times to allow all zones to be watered. If a start time produces a watering cycle that runs into the next start time, the controller will automatically move the next start time ahead to allow completion of the current watering cycle. If a start time produces a watering cycle that runs past midnight, any other start times programmed to start before midnight will be cancelled.

Start times can be entered in any order. Watering cycles progress by the time of day, not by start numbers. Foreexample, START 1A may actually be the last watering time of the day.

STEP 4: SET HOW LONG YOU WANT TO WATER EACH ZONE

Each zone can be set with a run time from 2 minutes to 3 hours.

A. To set the run times:

Move the switch under each zone to the desired watering time. (Place the switches on the minute/hour marks, not **between** the marks).

STEP 5: SET THE DAYS YOU WANT TO WATER

A. To set the watering days for each program, follow these steps:

Move the switch under "A" to the desired watering day(s) – "SUN" through "SAT" or every "2ND" or "3RD" day.

Repeat the above procedure for program "B".



Zones programmed to water on a certain day will be watered sequentially, skipping those zones programmed to "OFF". During watering, the zone number will appear on the left of the display, and the zone's run time will appear on the right. The display starts at one minute and counts up to the total run time before changing to the next zone to be watered.

PROGRAM A (Lawn)				PROGRAM B (Shrubs)			
START TIME "1A": 600 AM				START TIME "1B": 1030 PM			
START TIME "2A": 700 PM				START TIME "2B": - OFF -			
ZONE RUN TIMES		ZONE RUN TIME		ZONE RUN TIME		ZONE RUN TIME	
NO.	RUN TIME	NO.	RUN TIME	NO.	RUN TIME	NO.	RUN TIME
1	10	7	5	7	5		
2	15	8	1 hr.	8	1 hr.		
3	30	9	45	9	45		
4	20	10	OFF	10	OFF		
5	20	11	10	11	10		
8	30	12	3 hr	12	3 hr		
WATERING DAYS				WATERING DAYS			
SUN	ON OFF	SAT	ON OFF	SUN	ON OFF	SAT	ON OFF
MON	X		X	MON			
TUE	X			TUE		2ND	X
WED	X		3RD	WED		3RD	
THU	H X U		OFF	THU		O	F
FRI	X			FRI			

- Bring two wires up through the same hole used for the valve wiring.
- Connect one wire to the terminal marked "PUMP".
- Connect the second wire to a terminal marked "COMMON".
- If a master valve is required, the two wires should then be connected to a master valve, rated at 24VAC and a current no greater than 9 VA.
- If a pump start relay is required, connect the two wires to an auxillary relay with a coil rated at 24 VAC and a current no greater than 9 VA. The relay's contact would then be wired so it would supply voltage to the pump's contactor. A qualified electrician can make these connections for you. A Richdel 435 Pump Relay **can** be connected to the two wires and will directly control a pump up to 2 HP at 240 volts.

CAUTION: To prevent controller malfunctions, the controller must be placed (5) five feet from the relay and (12) twelve feet from the pump. The pump should be on a separate power circuit.

NOTE: The controller's pump output will be turned on whenever a zone is watering manually, automatically, etc.

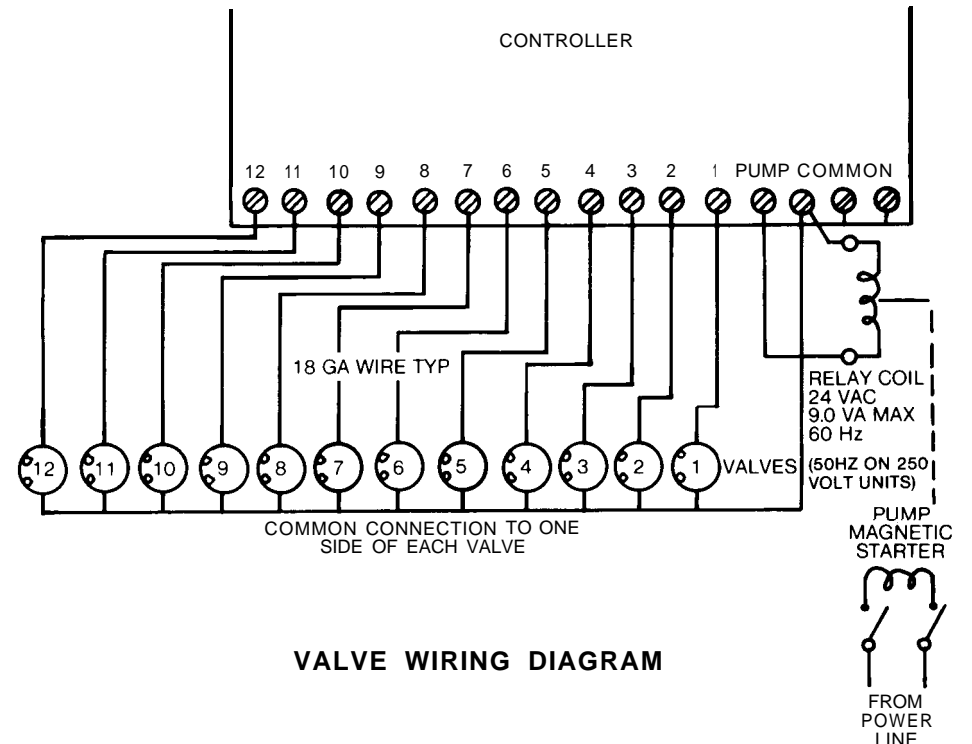

VALVE WIRING DIAGRAM

SPECIAL FUNCTIONS

MANUAL WATERING

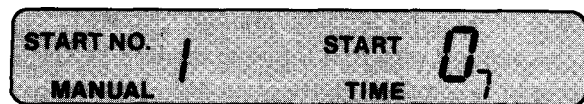



To water your yard manually move the “PROGRAM” switch to “MAN” for the zone you wish to water. The controller will allow only one zone at a time to be watered manually. If more than one program switch is placed in the “MAN” position, only the lowest number zone will water. When the switch is moved off the “MAN” position, the next lowest zone set on “MAN” will start to water.



The “MAN” setting will override any automatic or semi-automatic watering cycle, including any cycle in progress.

NOTE: When manual setting is used, water will stay on until the switch is moved. DO NOT LEAVE IN THIS POSITION !

SEMI-AUTOMATIC WATERING



If no watering is in progress, press the  key to start a semi-automatic watering cycle of all zones not set to “OFF”. To stop a semi-automatic cycle, press the  key. The watering in progress will stop, and the display will return to the time of day.

INTERRUPTING THE WATERING CYCLE

When an automatic or semi-automatic watering cycle is in progress, press  to freeze the cycle at that point of the zone’s run time. The display will alternately flash “PAUSE” and the zone’s number and run time. To resume the watering cycle, press  again, and the zone’s count will continue.

NOTE: If “PAUSE” is turned on and forgotten, the program will automatically reset itself at midnight. The controller will begin with the first start time for the new day.

TURNING OFF THE SYSTEM

When watering is not in progress, you can prevent automatic watering from starting by pressing the  key. A flashing “RAIN” message will appear on the display. To resume the automatic watering cycle, press the  key again.



If a watering cycle is in progress, zones will not resume watering until the next start time. Manual watering is still possible when the controller is in the “RAIN” mode.

ELECTRONIC CIRCUIT BREAKER

If the controller detects a short circuit, the shorted valve/zone will automatically be turned off. The display will then alternately flash “FUS” and the shorted zone number and run time. The controller will continue to automatically water the other zones and the following watering cycles with the display continuing to flash on the zone number with the short circuit.

After repairing the short, press the  key to return the controller and display back to its current operating mode.

VOLTAGE SPECIFICATIONS

DOMESTIC

Input
120 Volts AC
60 Hertz
18 Watts

output
24 Volts AC
1 AMP

INTERNATIONAL

Input
250 Volts AC
50 Hertz
18 Watts

output
24 Volts AC
1 AMP

TROUBLE-SHOOTING GUIDE

PROBLEM	POSSIBLE CAUSE
One or more valves do not water.	<ol style="list-style-type: none"> 1. Faulty solenoid. 2. Poor wire connection. 3. Possible break in wire. 4. Valve flow stem is screwed down too far.
Display is stuck on a zone and "FUS" is flashing in the display.	<ol style="list-style-type: none"> 1. Faulty solenoid. 2. Poor or shorted wire connection.
Continuous loss of program.	<ol style="list-style-type: none"> 1. No battery. 2. Weak or bad battery. 3. Controller on a circuit controlled by a switch. 4. Controller is on the same circuit as a high power user, (refrigerator, air conditioner, water pump etc.).
Zones turn on when they are NOT programmed to start.	<ol style="list-style-type: none"> 1. Start times and the total combined zone run times have overlapped.
The clock has the correct time and the zones appear to be functioning properly, but none of the valves are on.	<ol style="list-style-type: none"> 1. The controller is in "RAIN" mode. 2. The common wire is not hooked up. 3. Valve flow stem is screwed down too far.
One zone is stuck on and won't shut off electrically.	<ol style="list-style-type: none"> 1. Zone switch is in "MAN" position. 2. Faulty valve. 3. Particles of dirt or debris are stuck in the valve.

WARNING: DO NOT LINK TWO OR MORE CONTROLLERS VIA A COMMON TRANSFORMER OR COMMON WIRE.

ZONE LEGEND

ZONE	TIME	LOCATION
1		
2		
3		
4		
5		
6		
7		
8		
9		
10		
11		
12		

NOTES: