

Richdel®

HYBRID IRRIGATION CONTROLLER

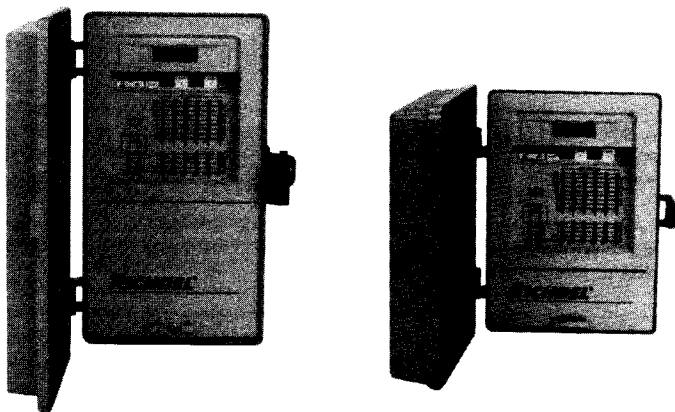

**INSTALLATION AND OPERATING GUIDE
MODELS 476PR & 476PRI**

FEATURES

- * **SIX STATION CONTROL:** Turns up to six sprinkler valves on and off automatically in sequence.
- * **DUAL PROGRAMMING:** Allows you to water your lawn and landscape on separate schedules.
- * **EASY AT-A-GLANCE SETTINGS:** Makes it simple to set watering lengths and days.
- * **MULTIPLE START TIMES:** Lets you water up to eight times per day — ideal for new lawns.
- * **EXTENDED WATERING PERIODS:** Allows you to water up to 60 minutes a day per station.
- * **ELECTRONIC CIRCUIT BREAKER:** Prevents controller shutdown in case of short circuit in a valve; diagnostic feature displays malfunctioning valve number for easy repair.
- * **PUMP START:** Automatically turns water pump or master valve on and off. (Requires a pump start relay, Model SR-1).
- * **MANUAL START MODE:** Lets you initiate a “Manual Cycle” with an “Advance” option to step through stations for ease of system testing.
- * **WATER DAYS SELECTIONS:** Lets you set 7-day specific programming or day interval options or everyday, every-other day, or every third day watering.

TO USE YOUR NEW CONTROLLER MOST EFFECTIVELY, PLEASE READ THIS MANUAL CAREFULLY BEFORE USE AND REFER TO THE MANUAL IF ANY DIFFICULTIES ARISE.

NOTE: For areas which are vulnerable to lightning strikes, or transient electrical surges caused by unstable power supply, consult your local supplier or contractor for additional protection devices which may be required. (SA120 for 60HZ or SA250 for 50HZ).

CONTENTS

ILLUSTRATION OF THE CONTROLLER PARTS	PAGES 4 & 6
INSTALLING YOUR 476PR OUTDOOR CONTROLLER	PAGE 8
STEP 1: SELECT THE LOCATION	
STEP 2: MOUNT THE CONTROLLER	
STEP 3: WIRE THE VALVES	
STEP 4: CONNECT THE VALVE WIRES TO THE CONTROLLER	
STEP 5: CONNECT THE TRANSFORMER	
STEP 6: CONNECT THE BATTERY	
INSTALLING YOUR 476PRI INDOOR CONTROLLER	PAGE 10
STEP 1: SELECT THE LOCATION	
STEP 2: MOUNT THE CONTROLLER	
STEP 3: WIRE THE VALVES	
STEP 4: CONNECT THE VALVE WIRES TO THE CONTROLLER	
STEP 5: CONNECT THE TRANSFORMER	
STEP 6: CONNECT THE BATTERY	
PROGRAMMING THE CONTROLLER	PAGE 12
STEP 1: SET THE CLOCK TO CURRENT TIME AND DAY	
STEP 2: SELECT THE RIGHT PROGRAM	
STEP 3: SET THE TIMES OF DAY YOU WANT TO WATER	
STEP 4: SET HOW LONG YOU WANT TO WATER EACH STATION	
STEP 5: SET THE DAYS YOU WANT TO WATER	
SAMPLE PROGRAM	
SPECIAL FUNCTIONS	PAGE 16
MANUAL WATERING	
MANUAL CYCLE, ADVANCE	
TURNING OFF THE SYSTEM	
ELECTRONIC CIRCUIT BREAKER	
VOLTAGE SPECIFICATIONS	PAGE 16
CONNECTING THE PUMP START RELAY OR THE MASTER VALVE	PAGE 17
TROUBLE-SHOOTING GUIDE	PAGE 18
STATION LEGEND	PAGE 19

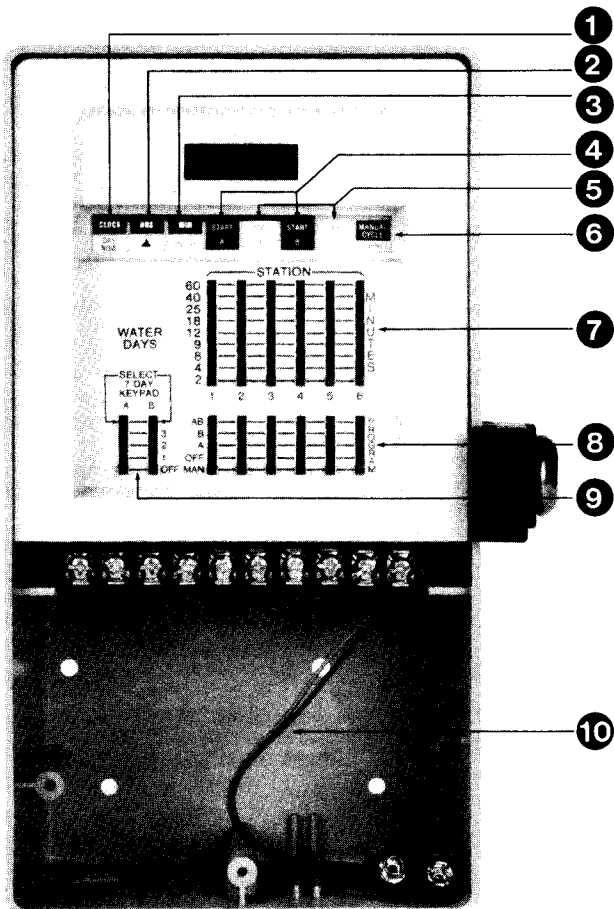

- 1 CLOCK, DAY NOW KEY**
A dual function key that selects the time of day or the day of the week for setting.
- 2 HOURS, ▲ KEY**
A dual function key that allows you to set the correct hour for time of day and start times or set the correct day of the week.
- 3 MINUTES, ON/OFF KEY**
A dual function key that allows you to set the correct minutes for the time of day and start times or provide "ON/OFF" control of the day selected by "DAYS A", "DAYS B" keys.
- 4 START KEYS**
Selects program start times (4 on program A, 4 on program B).
- 5 DAYS KEYS**
In the 7-day select mode, enables you to program specific days of the week to be "ON" and "OFF" per program.
- 6 MANUAL CYCLE, ADVANCE**
A dual function key that allows you to initiate a semi-automatic watering cycle and advance sequentially through the cycle to the next station.
- 7 STATION/MINUTES SWITCHES**
Allows you to select a separate watering time for each station from 2 - 60 minutes.
- 8 STATIONS/PROGRAM SWITCHES**
Allows you to select a different program or both programs for each station. (A, B or AB).
- 9 WATER DAYS SWITCHES**
Allows you to select day interval options of "1", (everyday), "2", (every other day), or "3", (every third day), "Select 7-day keypad", (for 7 Day specific programming) or "OFF" to prevent watering.
- 10 BATTERY CONNECTOR**
Connects to a 9V battery for program retention in the event of a power failure.

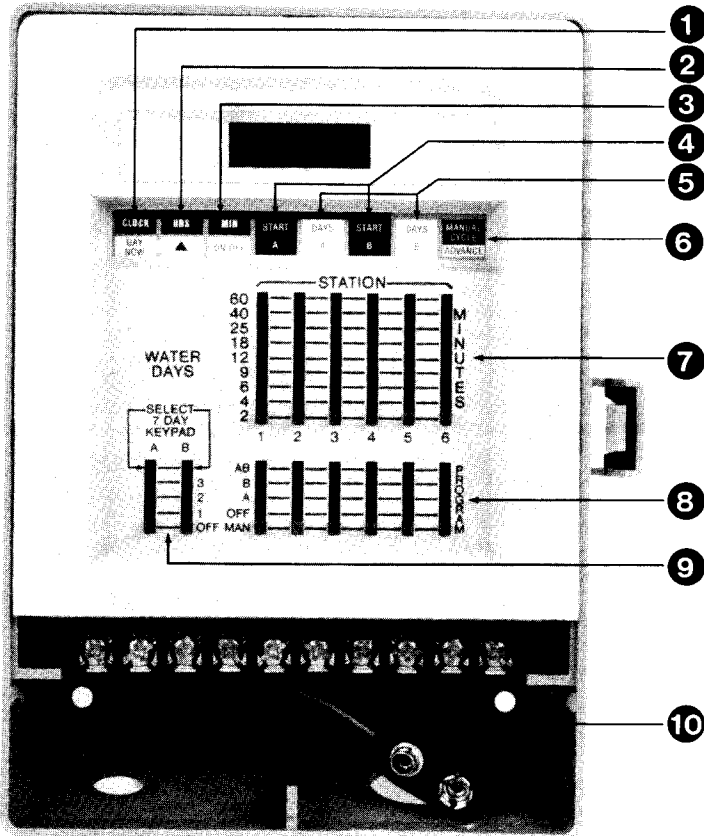

- 1 CLOCK, DAY NOW KEY**
A dual function key that selects the time of day or the day of the week for setting.
- 2 HOURS, ▲ KEY**
A dual function key that allows you to set the correct hour for time of day and start times or set the correct day of the week.
- 3 MINUTES, ON/OFF KEY**
A dual function key that allows you to set the correct minutes for the time of day and start times or provide "ON/OFF" control of the day selected by "DAYS A", "DAYS B" keys.
- 4 START KEYS**
Selects program start times (4 on program A, 4 on program B).
- 5 DAYS KEYS**
In the 7-day select mode, enables you to program specific days of the week to be "ON" and "OFF" per program.
- 6 MANUAL CYCLE, ADVANCE**
A dual function key that allows you to initiate a semi-automatic watering cycle and advance sequentially through the cycle to the next station.
- 7 STATION/MINUTES SWITCHES**
Allows you to select a separate watering time for each station from 2 - 60 minutes.
- 8 STATIONS/PROGRAM SWITCHES**
Allows you to select a different program or both programs for each station. (A, B or AB).
- 9 WATER DAYS SWITCHES**
Allows you to select day interval options of "1", (everyday), "2", (every other day), or "3", (every third day), "Select 7-day keypad", (for 7 day specific programming) or "Off" to prevent watering.
- 10 BATTERY CONNECTOR**
Connects to a 9V battery for program retention in the event of a power failure.
- 11 PLUG-IN TRANSFORMER**
Enables controller to run from a conventional 120V wall outlet (not shown).

INSTALLING YOUR NEW 476PR

INSTALLATION OF YOUR 476PR OUTDOOR MOUNT CONTROLLER

Before proceeding, please ascertain the model number of your controller and follow the installation instructions listed for that controller only.

Install your new controller by following these six steps:

STEP 1: SELECT THE LOCATION

- A. Select a protected location near a conventional 120 volt source.
CAUTION: The controller should not be placed where it is exposed to a temperature exceeding 55° Centigrade (130° Fahrenheit) or on a circuit controlled by a switch. Malfunctions may result.

STEP 2: MOUNT THE CONTROLLER

- A. Mount the hanger kit (1 hanger and 1 screw) to the top/back of the controller.
B. Remove the screw from the lower panel, pull the panel out and then down to remove.
C. Remove the high voltage wiring cover.
D. Mount the controller on a wall or other solid area to approximate eye level using the mounting hanger. To secure controller, use the screw hole located at the center bottom of the wiring cavity.

STEP 3: WIRE THE VALVES

- A. Use water tight connectors at all valve connections.
IMPORTANT: The power transformer is protected by an electronic circuit breaker. Do not connect a combination of valves requiring an inrush current of more than 1 AMP at 24 VAC. (Two valves maximum).

STEP 4: CONNECT THE VALVE WIRES TO THE CONTROLLER

- A. Bring valve wires up through the conduit hole on the bottom right of the controller.
B. Connect the wire from valve number 1 to the terminal screw on the controller marked "1", valve number 2 to terminal marked "2", and so forth.
NOTE: The terminal designation is marked on the inside of the wiring cover.
C. Connect the common wire to the terminal marked "COM".
D. If using a water pump or master valve, refer to page 17 for instructions and diagrams.
E. Use 18GA U.F. wire for runs under 800 ft. and 16GA U.F. wire for runs over 800 ft.

STEP 5: CONNECT THE TRANSFORMER

- A. Run the 120 VAC power wires into the wiring cavity using the 7/8" conduit hole in the bottom left of the controller. Connect the white wire as the common, the black wire as the power wire, and the green wire as earth ground with standard wire nuts.
B. Replace the high voltage wiring cover and screw.

STEP 6: CONNECT THE BATTERY

- Battery will keep program in memory during temporary power failures.
A. Connect a 9 volt alkaline battery (not supplied) to the battery connector in the wiring compartment of the controller.
B. Place battery in the wiring compartment.
C. Replace lower panel and screw.
D. Replace battery at least once a year. More often if frequent power failures occur.

CAUTION: DO NOT ALLOW THE BATTERY CONNECTOR TO TOUCH THE CONTROLLER'S TERMINAL STRIP (DIRECTLY ABOVE THE WIRING COMPARTMENT). ALSO, DO NOT CONNECT OR DISCONNECT VALVE WIRES WHILE STATIONS ARE IN OPERATION.

NOTE: Check local codes to be sure wiring and installation will meet all requirements.

250 VOLT INSTALLATIONS FOR 50HZ INTERNATIONAL UNITS ONLY

STEP 1: SELECT THE LOCATION

- A. Select a protected location near a conventional 250 volt source.

STEP 2: CONNECT THE TRANSFORMER

- A. Run the 250 VAC power wires into the wiring cavity using the 7/8" conduit hole in the bottom left of the controller. Connect the brown wire as common, the blue as the power wire, and the green wire as earth ground with standard wire nuts.

FOLLOW ALL OTHER INSTRUCTIONS AS DIRECTED.

INSTALLING YOUR NEW TIMER

INSTALLATION OF YOUR 476PRI INDOOR MOUNT CONTROLLER

Before proceeding, please ascertain the model number of your controller and follow the installation instructions for that controller only.

Install your new timer by following these six steps:

STEP 1: SELECT THE LOCATION

- A. Select an indoor location near a conventional 120 volt dual electrical outlet.

CAUTION: The timer should not be placed where it is exposed to a temperature exceeding 55° Centigrade (130° Fahrenheit) or on a circuit controlled by a switch. Malfunctions may result.

- B. If the timer is a distance from the outlet, replace the supplied cord with a similar electrical cord (available at hardware and electrical supply stores).

STEP 2: MOUNT THE TIMER

- A. Screw in a No. 8 screw at eye level, leaving the screw head extended 1/8".

- B. Slip the keyhole opening on the back of the timer over the screw head.

- C. Open the timer and install two screws through the holes in the wiring compartment at the bottom of the timer.

NOTE: To install the timer on a plaster or masonry wall, use plastic or lead shields to secure screws.

STEP 3: WIRE THE VALVES

- A. Place valve wiring underground where possible. (Under 800 feet, use 18 guage, plastic jacketed, thermostat control wire; over 800 feet, use 14 guage wire. This wire is available from your dealer in 2, 3, 4, 5, 6, 7, and 8 color coded wires).

- B. Run one common wire to all valves.

- C. Solder all splices, or join them with wire nuts and seal with vinyl cement or other waterproof cement.

IMPORTANT: The power transformer is protected by an electronic circuit breaker. Do not connect a combination of valves requiring an inrush current of more than 1 AMP at 24 VAC. (Two valves maximum).

STEP 4: CONNECT THE VALVE WIRES TO THE CONTROLLER

- A. Bring valve wires up through the hole on the bottom of the timer.
B. Connect the wire from valve number 1 to the terminal screw on the timer marked "1", valve number 2 to terminal "2", and so forth.

NOTE: The terminal designation is marked on the inside of the wiring cover.

- C. Connect the **common wire** to the terminal marked "**COMM**".

STEP 5: CONNECT THE TRANSFORMER

- A. Connect the power leads from the timer to the plug-in transformer.

- B. Attach one lead to each terminal screw on transformer. Be sure terminals on cord do not touch.

- C. Plug in transformer.

CAUTION: Use with supplied transformer ONLY!

STEP 6: CONNECT THE BATTERY

Battery will keep program in memory during temporary power failure.

- A. Connect a 9 volt alkaline battery (not supplied) to the battery connector in the wiring compartment of the timer box.

- B. Place the battery in the wiring compartment.

- C. Replace wiring compartment cover.

- D. Replace battery at least once a year. More often if frequent power failures occur.

CAUTION: DO NOT ALLOW THE BATTERY CONNECTOR TO TOUCH THE TIMER'S TERMINAL STRIP (DIRECTLY ABOVE THE WIRING COMPARTMENT). ALSO, DO NOT CONNECT OR DISCONNECT VALVE WIRES WHILE ANY STATIONS ARE IN OPERATION.

NOTE: Check local codes to be sure wiring and installation will meet all requirements.

PROGRAMMING YOUR NEW CONTROLLER



Before programming, read all instructions thoroughly.





STEP 1: SET THE CLOCK TO CURRENT TIME AND DAY





The controller's clock features a 12-hour format — 12 PM represents noon; 12 AM represents midnight. The AM or PM setting changes at 12:00 so that 11:59 AM progresses to 12:00 PM.

When the power is first turned on, the controller automatically displays a time of "400P" (4:00 PM).



To set the correct time:

- Press the  key.
- Press the  key and hold it down until the current hour and A (AM) or P (PM) rolls up on the display or repeatedly press the key to advance the numbers digit-by-digit.
- Press the  key repeatedly, or hold it down until the current minute rolls up on the display.

Press the  and  keys one press at a time for single digit changes. Hold the  and  keys down for fast changes.

Once you have pressed the  key, you must press the  or  key within 10 seconds. Otherwise, you must press the  key again to make the changes.

To set the correct day:

- Press the  key twice. (Display will show day-of-week).
- Press the  key repeatedly until the correct day code number appears in the display.

The correct day will be displayed as a number, please refer to the chart below for the correct day.

DAY CHART

Sun	Mon	Tue	Wed	Thu	Fri	Sat
1	2	3	4	5	6	7

STEP 2: SELECT THE RIGHT PROGRAM

The 476PR controller has several options that allow SIMPLE, FLEXIBLE programming never before offered. The newest of these is the multiple programs option which provides the ability to water individual areas of any yard separately. These programs are displayed on the face of the controller by the letters "A", "B" & "AB".

A simple example of how these programs might be used would be to use program "A" to water all the grass areas of the yard every other day. Use program "B" to water all the shrub or ground cover areas of the yard daily. The "AB" program would normally only be used when new grass is being established and more than 4 start times per day are needed.





NOTE: Any of the 6 stations can be set to water in any combination within the "A", "B" or "AB" programs. Page 15 shows a sample program.





Move the "PROGRAM" switch under each station to the desired watering day program — "PROGRAM A", "B", "AB", "OFF" or "MAN" (for manual watering).

STEP 3: SET THE TIMES OF DAY YOU WANT TO WATER

Now that the program selections have been made, the times that each program should start need to be set. This is done by using the "START" keys located to the right of the display. Note that there are 2 keys to choose from: "AM" and "PM". There are 4 start times for all "A" stations and 4 start times for all "B" stations.

The key marked with the letter "A" will start all the stations where the program switch is located on the letter "A" and the same is true for the stations where the switch is located on "B". To program the start times for "A" stations, follow these steps:

- Press the  key. (The display will show "200A").
- Press the  key and hold it until the desired hour and "A" (AM) or "P" (PM) is displayed.
- Press the  key and hold it until the desired minute is displayed.
- Repeat this procedure for all the remaining start times.
- If any of the 4 start times are not needed be sure to set it to the "OFF" position. This is done by holding the  key until the word "OFF" is shown in the display. This occurs just after "1100P".

NOTE: If a program switch is placed in "AB" position that station would start at every start time programmed. (Up to 8). Once you have pressed a  key, you must press the  or  key within 20 seconds. Otherwise, you must press the  key again to make the changes.

Leave enough time between start times to allow all stations to be watered. If a start time produces a watering cycle that runs into the next start time, the controller will automatically move the next start time ahead to allow completion of the current watering cycle. If a start time produces a watering cycle that runs past midnight, any other start times programmed to start before midnight will be cancelled. Start times can be entered in any order. Watering cycles progress by the time of day, not by start numbers.

STEP 4: SET HOW LONG YOU WANT TO WATER EACH STATION

Each station can be set with a run time from 2 minutes to 60 minutes.

- To set the run times:
Move the switch under each "STATION" to the desired watering time. (Place the switches on the minute/hour marks, not **between** the marks).



STEP 5: SET THE DAYS YOU WANT TO WATER

- A. To set the watering days for each program, follow these steps:
Move the switch under "A" to the desired watering day(s) — "3" (every 3rd day), "2" (every 2nd day), "1" (every day), or "OFF".
- B. If desired, repeat the above procedure for program "B".
Stations programmed to water on a certain day will be watered sequentially, skipping those stations programmed to "OFF". During watering, the station number will appear on the left of the display, and the station's run time will appear on the right. The display starts at one minute and counts up to the total run time before changing to the next station to be watered.

TO SET A 7-DAY SPECIFIC CALENDAR

- A. Please refer to the "Day Chart" for day number information.

DAY CHART

Sun	Mon	Tue	Wed	Thu	Fri	Sat
1	2	3	4	5	6	7

- B. Move the switch under "Water Days A" to the "Select 7-Day keypad" position.
- C. Press the **ON** key, (display will show "1 ON" (day 1 on).
- D. Press the **OFF** key to program "OFF", or press again to program "ON".
- E. Press the **ON** key again to advance to the next day (ie "2 ON, 2 OFF")
- F. Repeat procedure for all 7 days.
- G. If using program "B", repeat procedure for "Water Days B", "Days B".

SAMPLE PROGRAM

PROGRAM A (Lawn)		PROGRAM B (Shrubs)	
START TIME "1A":	600 AM	START TIME "1B":	1030 PM
START TIME "2A":	700 PM	START TIME "2B":	— OFF —
Station #	Run Time (2-60 Min)	Station #	Run Time (2-60 Min)
1	10	1	
2	15	2	
3	30	3	
4	20	4	
5		5	5
6		6	60
WATERING DAYS (Choose 1 only)		WATERING DAYS (Choose 1 only)	
Select 7-day keypad	_____	Select 7-day keypad	_____
Every 3rd day	_____	Every 3rd day	_____
Every 2nd day	_____ x _____	Every 2nd day	_____
Every day	_____	Every day	_____ x _____
OFF		OFF	

MANUAL WATERING

To water your yard manually move the “PROGRAM” switch to “MAN” for the station you wish to water. The controller will allow only one station at a time to be watered manually. If more than one program switch is placed in the “MAN” position, only the lowest number station will water. When the switch is moved off the “MAN” position, the next lowest station set on “MAN” will start to water.

The “MAN” setting will override any automatic or semi-automatic watering cycle, including any cycle in progress.

NOTE: When manual setting is used, water will stay on until the switch is moved. DO NOT LEAVE IN THIS POSITION!

MANUAL CYCLE, ADVANCE WATERING

To initiate a semi-automatic watering cycle which will water all stations sequentially for their set watering times, press the **MANUAL CYCLE ADVANCE** key.

To step through the stations during a semi-automatic cycle, press the **MANUAL CYCLE ADVANCE** key a second time. Each time the **MANUAL CYCLE ADVANCE** key is pressed during a semi-automatic cycle the controller will advance sequentially to the next station with watering time.

TURNING OFF THE SYSTEM

When watering is not in progress, you can prevent automatic watering by moving the “DAY A” and “B” switches to “OFF”.

Manual watering is still possible when the controller is in the “OFF” mode.



ELECTRONIC CIRCUIT BREAKER

If the controller detects a short circuit, the shorted valve/station will automatically be turned off. The display will then alternately flash “FUS” and the shorted station number and run time. The controller will continue to automatically water the other stations and the following watering cycles with the display continuing to flash on the station number with the short circuit.

After repairing the short, press the **CLOCK** or any **START** key to return the controller and display back to its current operating mode.

VOLTAGE SPECIFICATIONS

DOMESTIC

INPUT
120 Volts AC
60 Hertz
35 Watts

OUTPUT
24 Volts AC
1 AMP

INTERNATIONAL

INPUT
250 Volts AC
50 Hertz
18 Watts

OUTPUT
24 Volts AC
1 AMP

- Bring two wires up through the same conduit hole used for the valve wiring.
 - Connect one wire to the terminal marked “PUMP”.
 - Connect the second wire to the terminal marked “COM”.
 - If a master valve is required, the two wires should then be connected to a master valve, rated at 24 VAC and a current no greater than 9 VA.
 - If a pump start relay is required, connect the two wires to an auxiliary relay with a coil rated at 24 VAC and a current no greater than 9 VA. The relay's contact would then be wired so it would supply voltage to the pump's contactor. A qualified electrician can make these connections for you. A Richdel SR-1 Pump Relay can be connected to the two wires and will directly control a pump up to 2 HP at 240 volts.
- NOTE:** The controller's pump output will be turned on whenever a station is watering manually, automatically, etc.

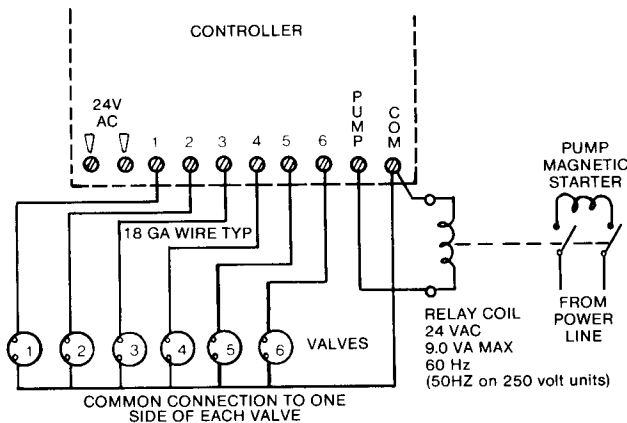

VALVE WIRING DIAGRAM

TROUBLE-SHOOTING GUIDE

PROBLEM	POSSIBLE CAUSE
One or more valves do not water.	<ol style="list-style-type: none"> 1. Faulty solenoid. 2. Poor wire connection. 3. Possible break in wire. 4. Valve flow stem is screwed down too far.
Display is stuck on a station and "FUS" is flashing in the display.	<ol style="list-style-type: none"> 1. Faulty solenoid. 2. Poor or shorted wire connection.
Continuous loss of time.	<ol style="list-style-type: none"> 1. No battery. 2. Weak or bad battery. 3. Controller on a circuit controlled by a switch. 4. Controller is on the same circuit as a high power user, (refrigerator, air conditioner, etc.).
Stations turn on when they are NOT programmed to start.	<ol style="list-style-type: none"> 1. Start times and the total combined station run times have overlapped.
The clock has the correct time and the stations appear to be functioning properly, but none of the valves are on.	<ol style="list-style-type: none"> 1. One or more station switches are in the "OFF" position. 2. The common wire is not hooked up. 3. Valve flow stem is screwed down too far.
One station is stuck on and won't shut off electrically.	<ol style="list-style-type: none"> 1. Station switch is in "MAN" position. 2. Faulty valve. 3. Particles of dirt or debris are stuck in the valve.

WARNING: DO NOT LINK TWO OR MORE CONTROLLERS VIA A COMMON TRANSFORMER OR COMMON WIRE.

STATION LEGEND

STATION	TIME	LOCATION
1		
2		
3		
4		
5		
6		

NOTES:



A James Hardie Company

FOR PRODUCT INQUIRIES AND REPAIRS
27631 LA PAZ ROAD
LAGUNA NIGUEL, CA 92656

P/N 545001

MANUFACTURING
9455 RAILROAD DRIVE
EL PASO, TEXAS 79924

REV. A