

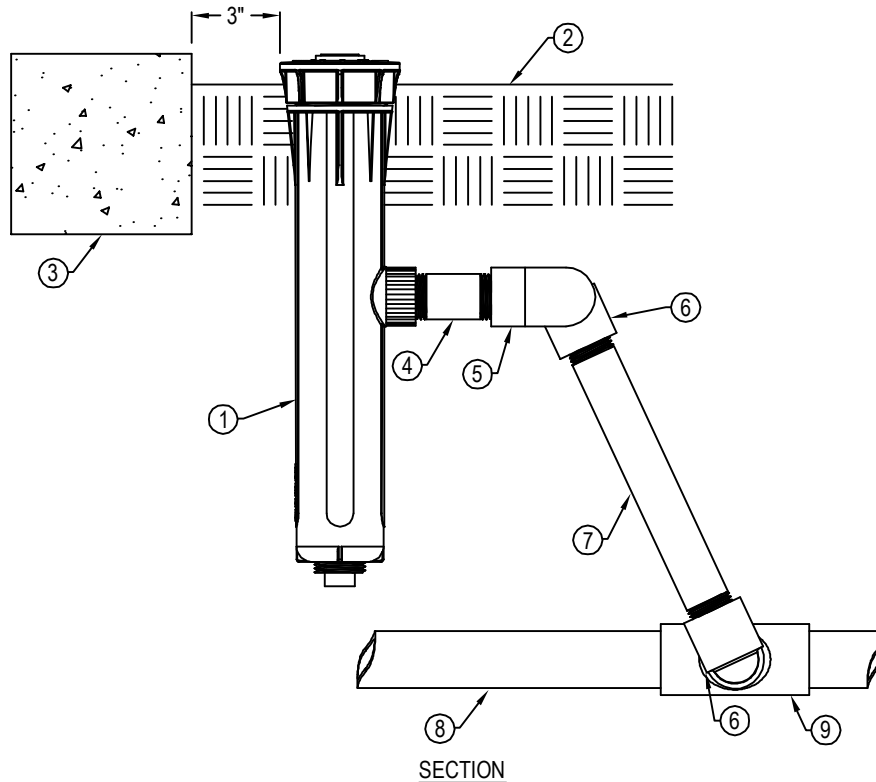

IRRITROL SYSTEMS
 5825 JASMINE ST.
 RIVERSIDE, CA 92504
 TOLL FREE: 1-800-634-8873
 PHONE: (951) 785-3454
 www.irritrol.com



SECTION

LEGEND:

- ① IRRITROL I-PRO600 PVC 6" POP-UP SPRAY SPRINKLER WITH NOZZLE.
- ② FINISH GRADE.
- ③ CURB, SIDEWALK OR FOUNDATION.
- ④ PVC SCHEDULE 80 1/2" X 2" NIPPLE OPTIONAL CHECK VALVE INSTALLED HERE IF REQUIRED.
- ⑤ PVC THREAD X THREAD 90° ELL.
- ⑥ MARLEX STREET ELL.
- ⑦ PVC SCHEDULE 80 NIPPLE (8" MIN LENGTH).
- ⑧ LATERAL LINE PIPING.
- ⑨ LATERAL LINE PIPE FITTING (TEE OR ELBOW).

NOTES:

- 1. TEFLON TAPE ALL THREADED JOINTS.
- 2. INSTALLATION TO BE COMPLETED IN ACCORDANCE WITH MANUFACTURER'S SPECIFICATIONS.
- 3. DO NOT SCALE DRAWING.
- 4. THIS DRAWING IS INTENDED FOR USE BY ARCHITECTS, ENGINEERS, CONTRACTORS, CONSULTANTS AND DESIGN PROFESSIONALS FOR PLANNING PURPOSES ONLY. THIS DRAWING MAY NOT BE USED FOR CONSTRUCTION.
- 5. ALL INFORMATION CONTAINED HEREIN WAS CURRENT AT THE TIME OF DEVELOPMENT BUT MUST BE REVIEWED AND APPROVED BY THE PRODUCT MANUFACTURER TO BE CONSIDERED ACCURATE.
- 6. CONTRACTOR'S NOTE: FOR PRODUCT AND COMPANY INFORMATION VISIT www.CADdetails.com/info AND ENTER REFERENCE NUMBER 743-025.

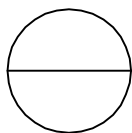

SPRAY HEADS

I-PRO 600 SERIES WITH PVC